

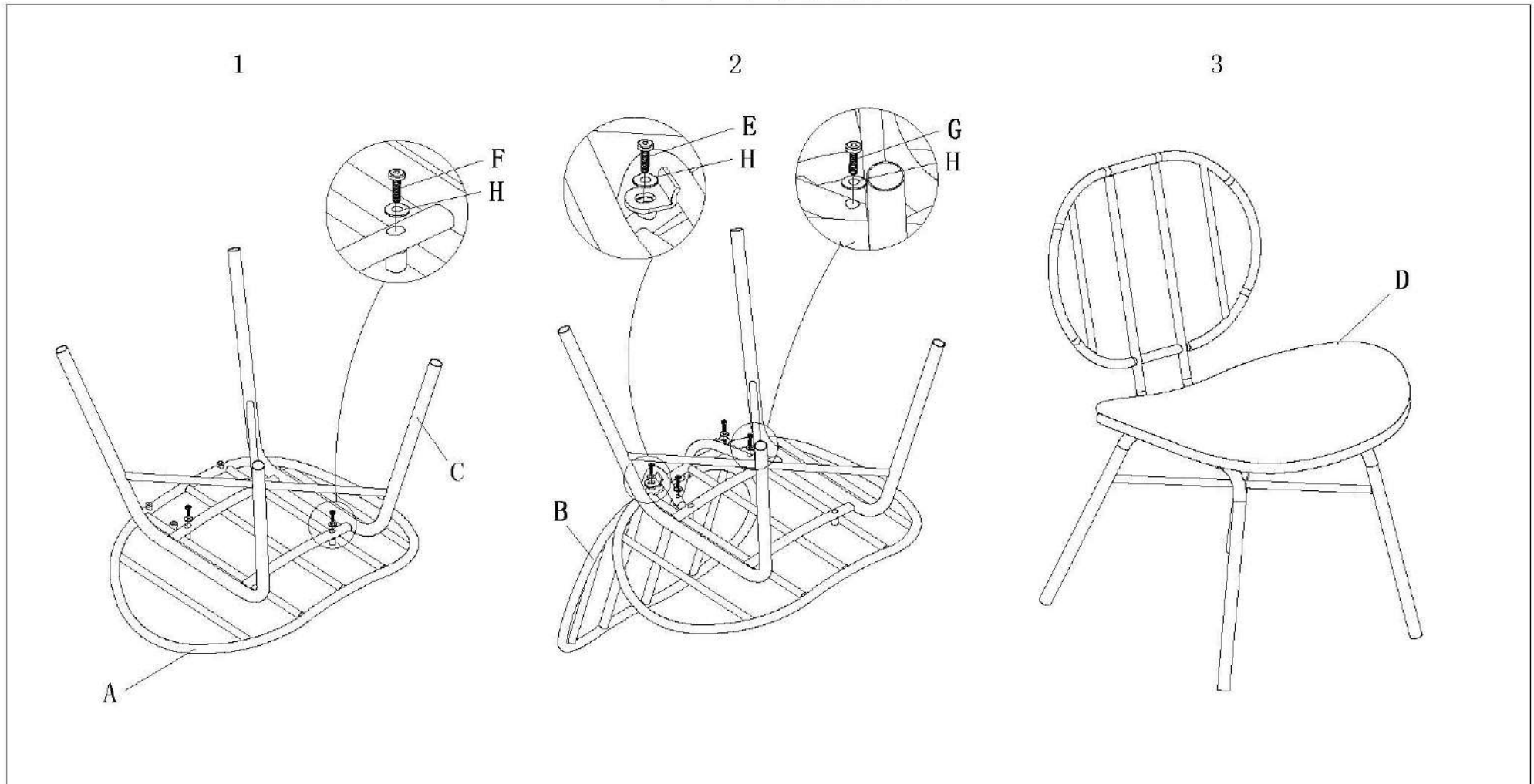









# FT-2205B



<p><b>A</b></p>  <p>1PC</p>	<p><b>B</b></p>  <p>1PC</p>	<p><b>C</b></p>  <p>1PC</p>	<p><b>D</b></p>  <p>1PC</p>	<p><b>E</b></p>  <p>M6*15 2PCS</p>
<p><b>F</b></p>  <p>M6*25 4PCS</p>	<p><b>G</b></p>  <p>M6*30 2PCS</p>	<p><b>H</b></p>  <p>M6 8PCS</p>	<p><b>I</b></p>  <p>1PC</p>	

**JardiLINE**  
ARCHITECTE D'EXTÉRIEUR