

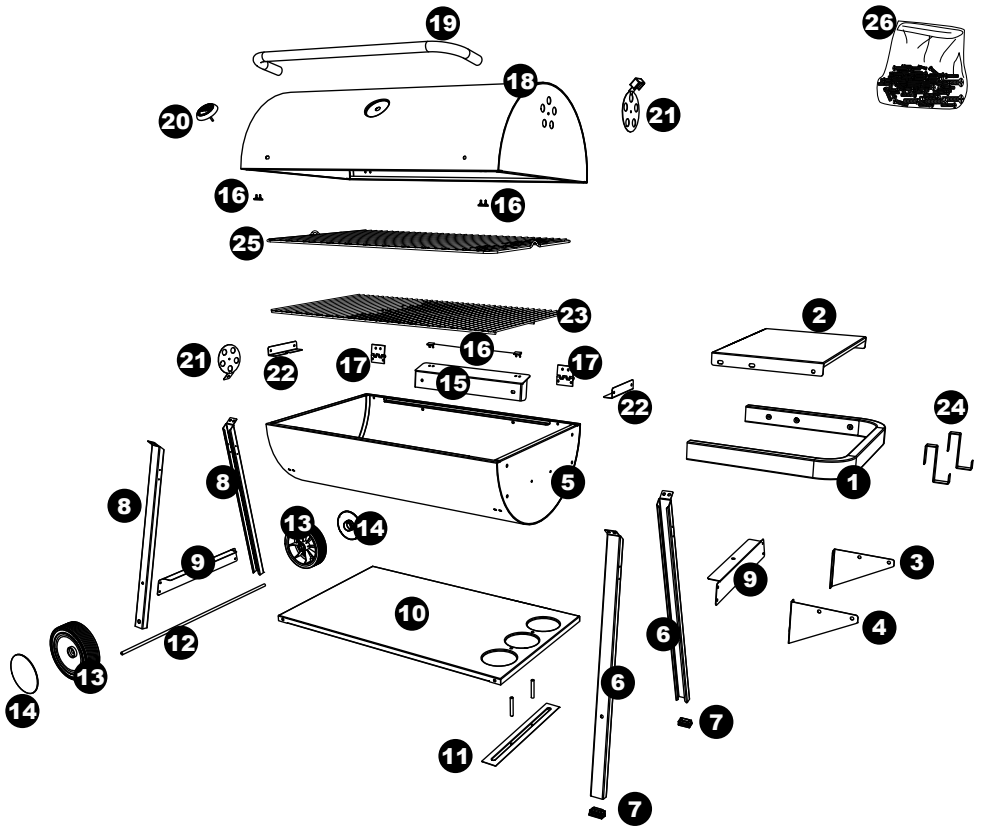











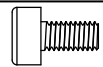















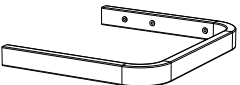

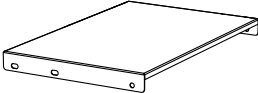

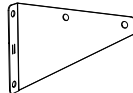

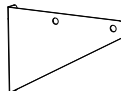

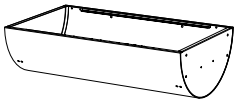
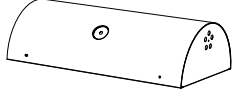



# TOM 310049i EN

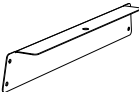

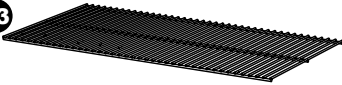
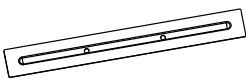

|   |           |    |
|---|-----------|----|
|    | 8 x 55    | 2  |
|   | 6 x 65    | 2  |
|  | 6 x 35    | 4  |
|  | 6 x 12    | 6  |
|  | 6 x 16    | 2  |
|  | 6 x 12    | 16 |
|  | 4 x 12    | 14 |
|  | 3,5 x 9,5 | 8  |
|  | N°5       | 1  |

|   |      |    |
|---|------|----|
|  | Ø 8  | 1  |
|  | Ø 6  | 30 |
|  | Ø 4  | 14 |
|  | Ø 10 | 2  |
|  | Ø 8  | 1  |
|  | Ø 6  | 22 |
|  | Ø 4  | 12 |
|  | Ø 4  | 2  |

|           |   |     |           |   |     |
|-----------|---|-----|-----------|---|-----|
| <b>1</b>  |    | x 1 | <b>14</b> |    | x 2 |
| <b>2</b>  |    | x 1 | <b>15</b> |    | x 1 |
| <b>3</b>  |    | x 1 | <b>16</b> |    | x 4 |
| <b>4</b>  |    | x 1 | <b>17</b> |    | x 2 |
| <b>5</b>  |    | x 1 | <b>18</b> |    | x 1 |
| <b>6</b>  |    | x 2 | <b>19</b> |    | x 1 |
| <b>7</b>  |    | x 2 | <b>20</b> |    | x 1 |
| <b>8</b>  |    | x 2 | <b>21</b> |    | x 2 |
| <b>9</b>  |   | x 2 | <b>22</b> |  | x 2 |
| <b>10</b> |  | x 1 | <b>23</b> |  | x 1 |
| <b>11</b> |  | x 1 | <b>24</b> |  | x 2 |
| <b>12</b> |  | x 1 | <b>25</b> |  | x 1 |
| <b>13</b> |  | x 2 | <b>26</b> |  | x 1 |

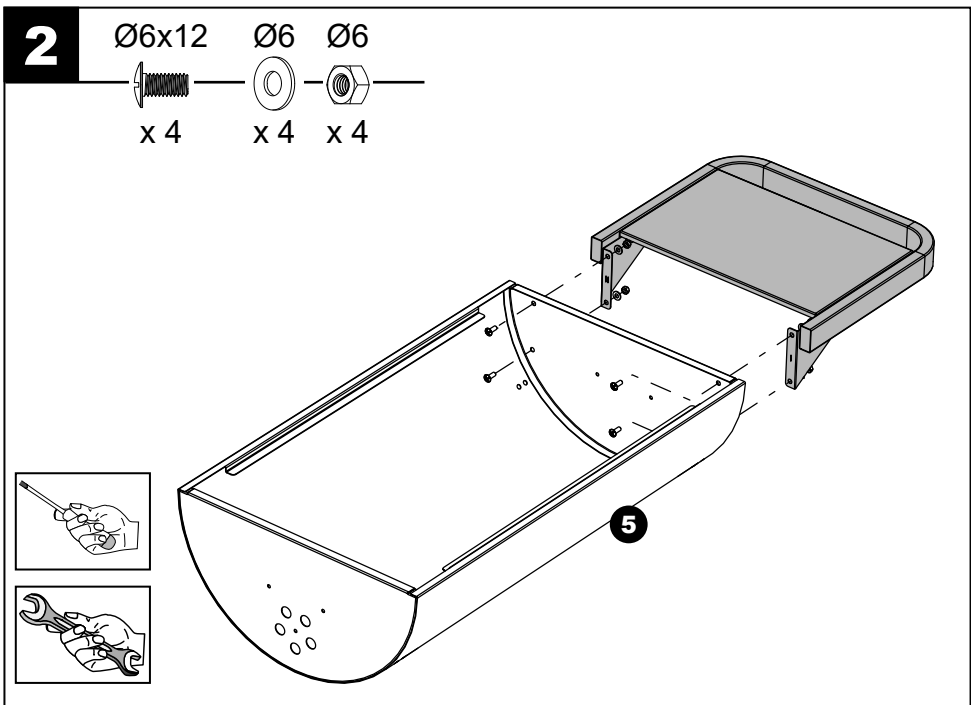
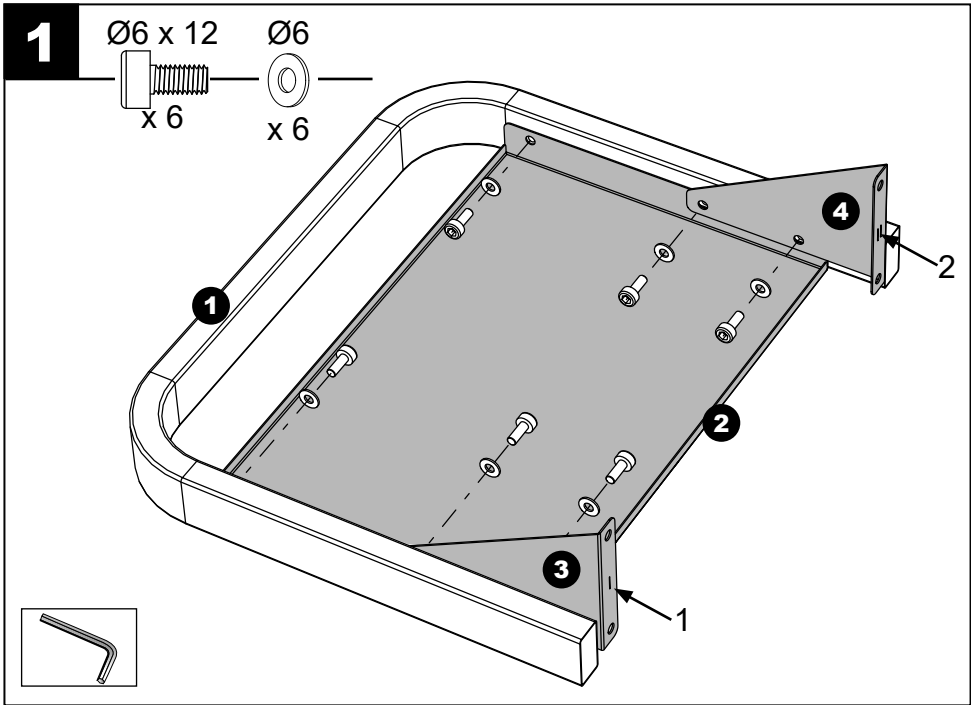

**3**

Ø6x12

Ø6

Ø6



x 4

x 4

x 4

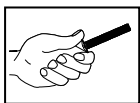
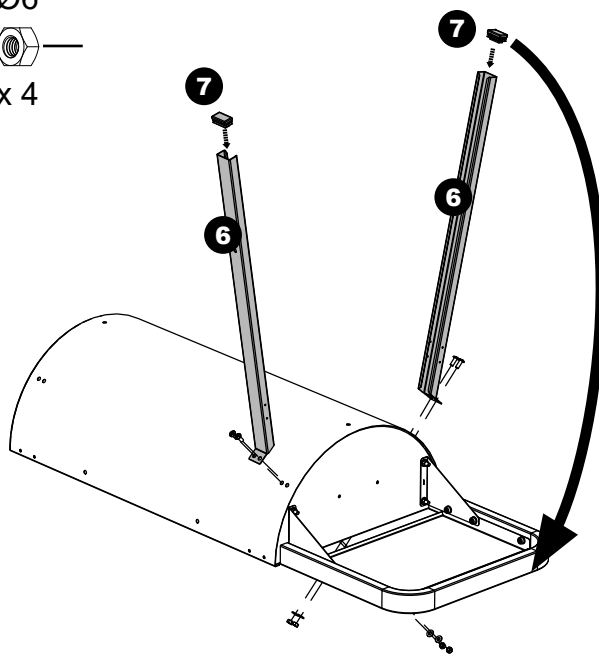
**4**

Ø6x12

Ø6

Ø6

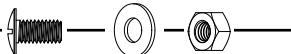

x 4

x 4

x 4

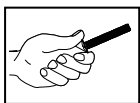
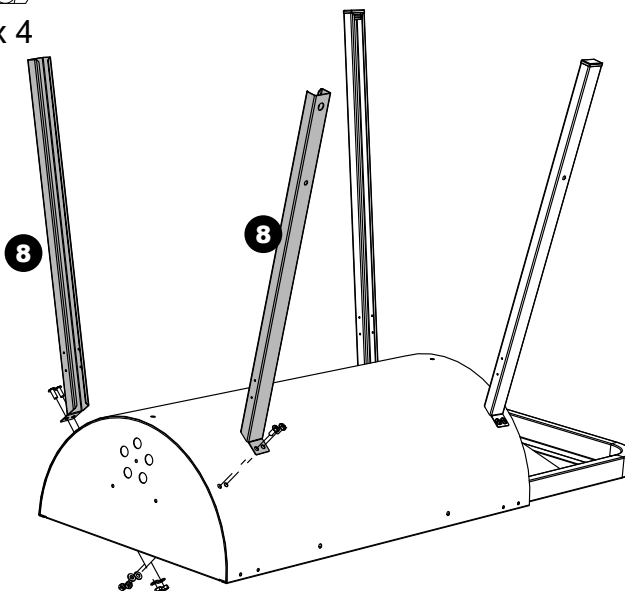

**5**

Ø3,5 x 9,5

Ø6x12

Ø6x35

Ø6

Ø6

x 8a

x 2b

x 4c

x 8

x 8

Ø6x65

x 2d

Ø8x55

x 2

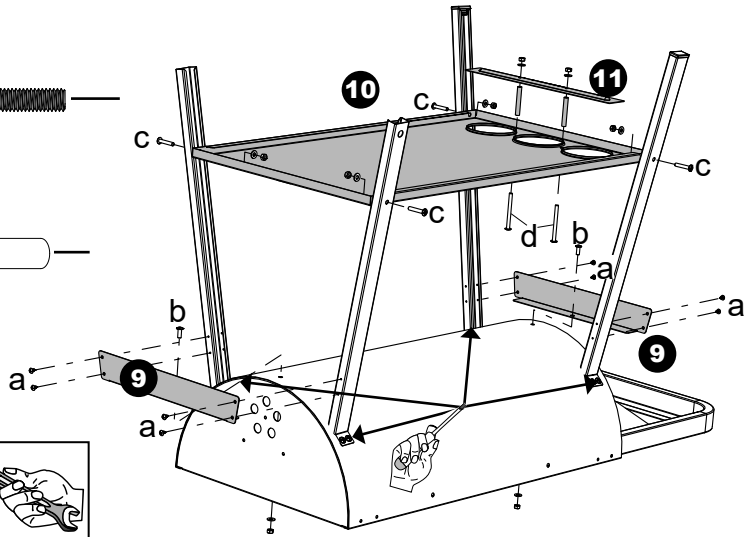
**6**

Ø10 Nylstop



x 2

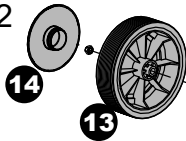

14

13

12

13

14

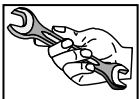

**7**

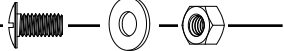
$\varnothing 6 \times 12$     $\varnothing 6$     $\varnothing 6$   

x 2   x 2   x 2

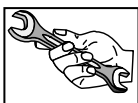
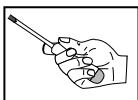
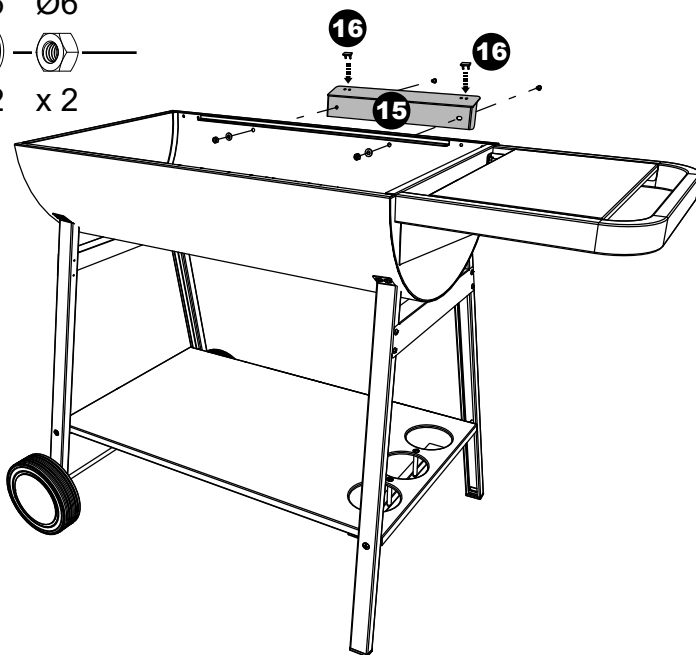
**8**

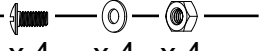
$\varnothing 4 \times 12$     $\varnothing 4$     $\varnothing 4$   

x 4   x 4   x 4

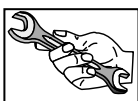
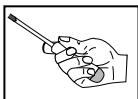
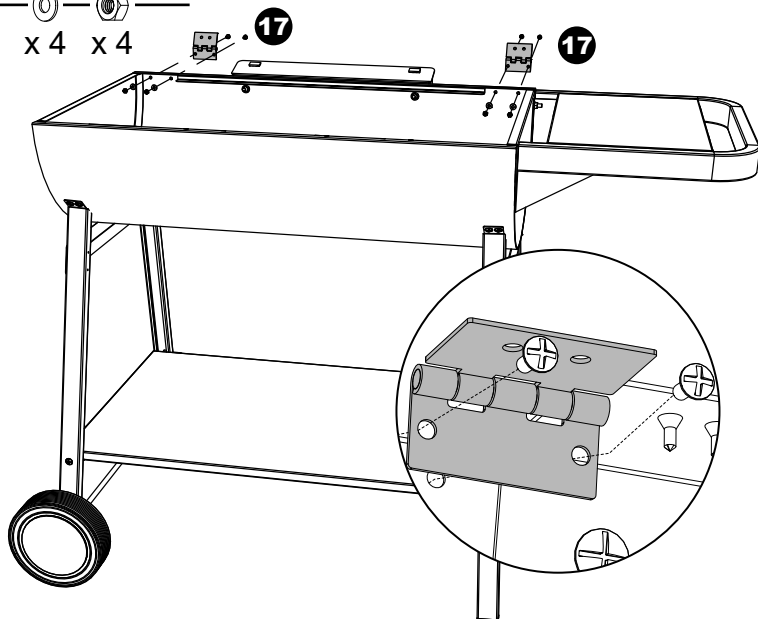

**9**

Ø4x12 Ø4 Ø4

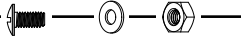
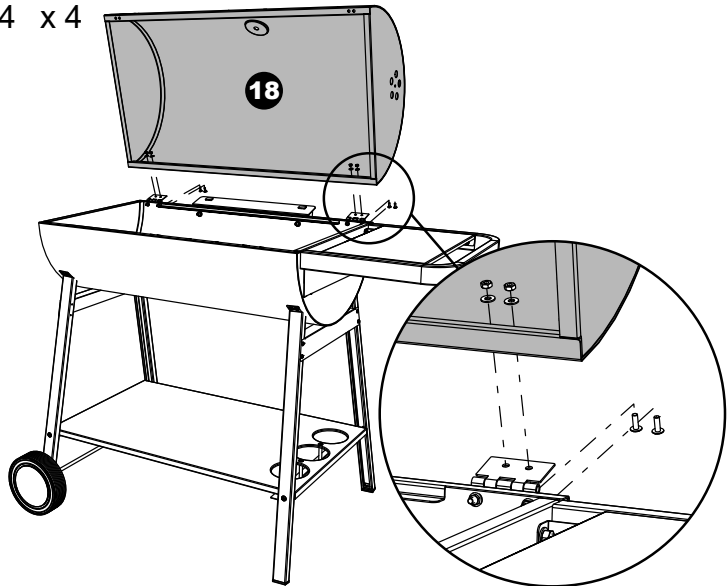
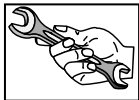
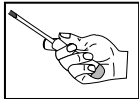
  
 x 4 x 4 x 4
**10**

Ø6 x 16 Ø6 Ø8 Ø8

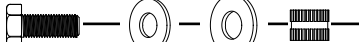
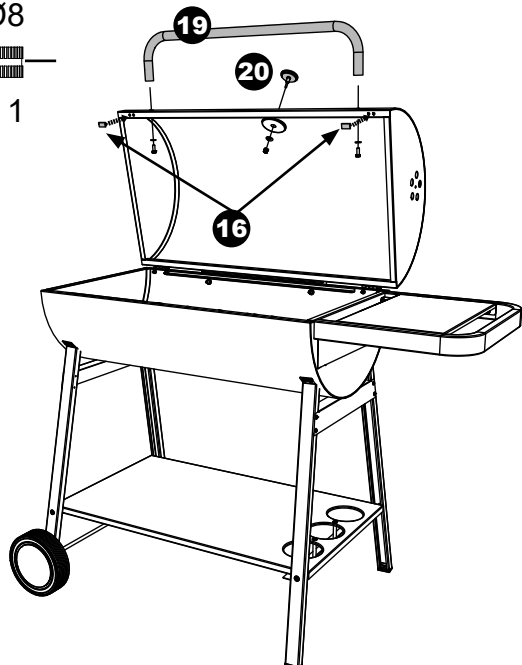
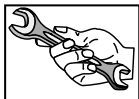
  
 x 2 x 2 x 1 x 1



# 11

Ø4x12

Ø4

Ø4

x 1

x 1

x 1  
brake nut

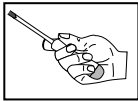
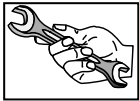

# 12

Ø4x12

Ø4

Ø4

Ø4

x 5

x 5

x 1  
brake nut

x 4

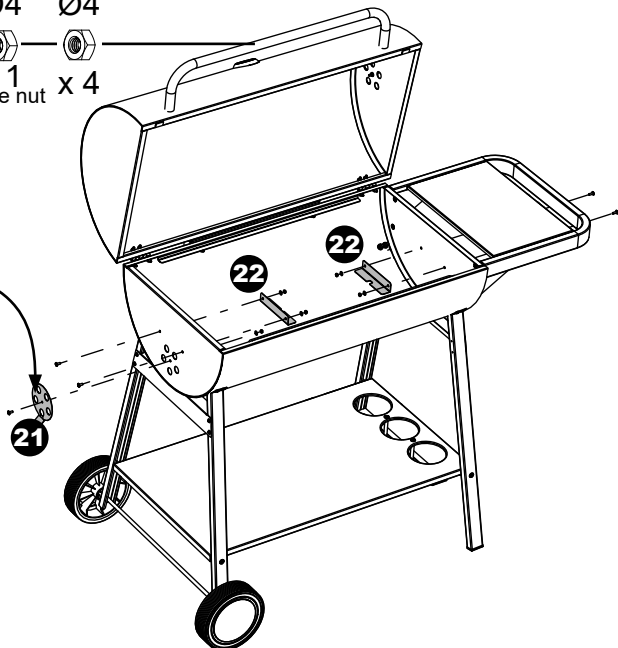
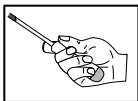
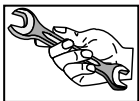

**13**



**14**

