

LAMS

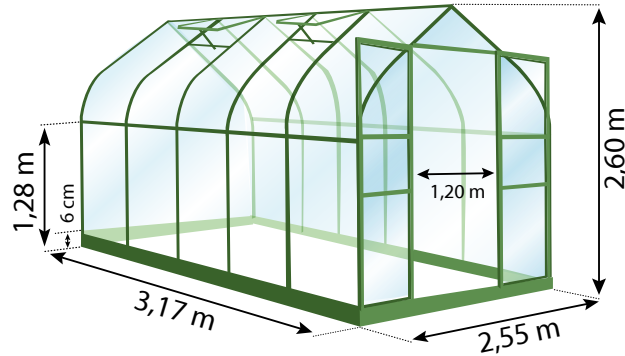

2

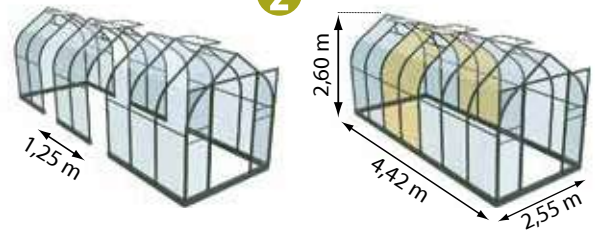

1

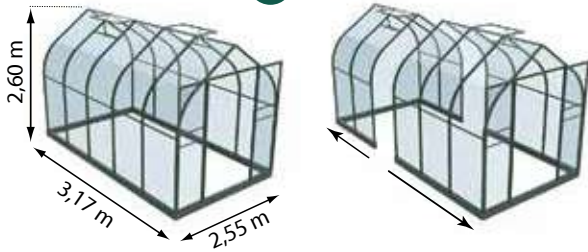

3

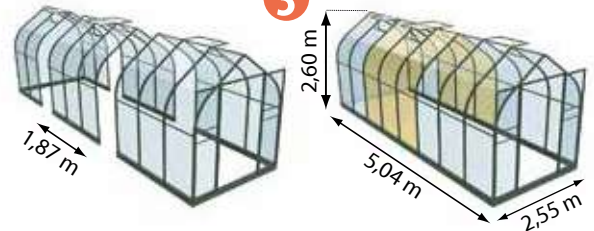

1 Module de base - Basismodul - Basic module
3,17 x 2,55 x 2,60 m (8,10 m²)

2 Extension - Erweiterung - Extension
1,25 x 2,55 x 2,60 m (3,20 m²)

3 Extension - Erweiterung - Extension
1,87 x 2,55 x 2,60 m (4,80 m²)

SERRES - GEWÄCHSHÄUSER - GREENHOUSES

ALOÉ

8,10 M² / 11,30 M² / 12,90 M²



NOTICE DE MONTAGE

IMPORTANT

- Merci de lire ces instructions attentivement avant de commencer le montage de la serre.
- Merci de vous assurer que toutes les pièces mentionnées sur cette notice sont présentes dans le carton et de vérifier les quantités.
- Merci de suivre les étapes dans l'ordre indiqué par la notice.
- Veuillez conserver soigneusement ce manuel de montage pour une consultation ultérieure.

CONSEILS DE SÉCURITÉ

- Veuillez porter gants, chaussures et lunettes de protection pour le montage de la serre.
- Respectez les conseils de sécurité des outils que vous utilisez pour ce montage.
- En cas d'intempéries (pluie, vent, orage...), ne montez pas votre serre.
- La serre doit être montée par 2 personnes.
- Les sachets plastiques et les petits composants sont à tenir hors de portée des enfants. Eloignez les enfants de la zone de montage.
- L'aluminium est un métal conducteur d'électricité, tenez les profilés aluminium éloignés de toute source électrique.
- Tout appareil produisant de la chaleur ne doit pas être stocké dans la serre (barbecue, chalumeau, ...).
- La serre doit être positionnée et fixée sur un sol horizontal et plan, non exposé au vent.
- Vérifiez l'absence de réseaux (eau, électricité, gaz) sous l'emplacement de montage de la serre.
- Attention, ne pas monter sur le toit : risque de chute et de blessures graves.
- En cas de forte chute de neige ne pas laisser la neige s'accumuler sur le toit.
- **Ne vissez pas de façon définitive tous les éléments avant l'assemblage complet du produit (à l'exception de la base). Une fois les verres et polycarbonates positionnés vous pouvez visser de manière définitive.**

CONSEILS D'ENTRETIEN

- Pour nettoyer votre serre, utilisez de l'eau claire savonneuse.
- N'utilisez surtout pas d'acétone, des nettoyants abrasifs ou autres détergents spéciaux pour nettoyer les panneaux.
- Graissez régulièrement le rail de porte.
- Dégagez le toit de la neige et des feuilles.



SERVICE CLIENTS

Site internet : www.sav-doviris.com



MONTAGEANLEITUNG

WICHTIG

- Bitte lesen Sie diese Anleitung sorgfältig durch, bevor Sie mit der Montage beginnen.
- Bitte stellen Sie sicher, dass alle in dieser Anleitung aufgeführten Einzelteile im Karton vorhanden sind und prüfen Sie die Mengen.
- Bitte folgen Sie den Schritten in der im Handbuch angegebenen Reihenfolge.
- Bewahren Sie diese Anleitung für späteres Nachschlagen sorgfältig auf.

SICHERHEITSHINWEISE

- Bitte tragen Sie bei der Montage des Gewächshauses Handschuhe, Schuhe und Schutzbrille.
- Beachten Sie die Sicherheitshinweise der Werkzeuge, die Sie für diese Montage verwenden.
- Stellen Sie Ihr Gewächshaus nicht bei schlechtem Wetter (Regen, Wind, Gewitter. . .) auf.
- Das Gewächshaus muss von 2 Personen zusammengebaut werden.
- Die Plastiktüten und Kleinteile sollten außerhalb der Reichweite von Kindern aufbewahrt werden. Halten Sie die Kinder vom Montagebereich fern.
- Aluminium ist ein elektrisch leitfähiges Metall, halten Sie die Aluminiumprofile von allen elektrischen Quellen fern.
- Nicht alle wärmeerzeugenden Geräte (Grill, Brenner, . . .) dürfen im Gewächshaus gelagert werden.
- Das Gewächshaus muss auf einem horizontalen und ebenen, nicht dem Wind ausgesetzten Boden aufgestellt und befestigt werden.
- Stellen Sie sicher, dass es keine Netze (Wasser, Strom oder Gas) unter dem Installationsort gibt.
- Achtung, nicht auf das Dach steigen: Sturz- und schwere Verletzungsgefahr.
- Bei starkem Schneefall den Schnee nicht auf dem Dach ansammeln lassen.
- **Schrauben Sie nicht alle Einzelteile vor dem vollständigen Zusammenbau des Produktes (Fundamentrahmen ausgenommen) fest. Sie können die Schrauben fest anziehen sobald die Gläser und Stegplatten angebracht worden sind.**

PFLEGEHINWEISE

- Verwenden Sie zur Reinigung Ihres Gewächshauses klares Seifenwasser.
- Verwenden Sie kein Aceton, Scheuermittel oder andere Reinigungsmittel zum Reinigen der Platten.
- Regelmäßig die Türschiene schmieren.
- Räumen Sie das Dach frei von Schnee und Laub.



KUNDENSERVICE

kontakt@gewaechshaus-lams.com



ASSEMBLY INSTRUCTIONS

IMPORTANT

- Please read these instructions carefully before starting to assemble the greenhouse.
- Please ensure that all the components mentioned in this instruction are present in the box and check the quantities.
- Please follow the steps in the order indicated by the manual.
- Please keep this assembly instruction in a safe place for future reference.

SAFETY WARNINGS

- Please wear gloves, shoes and safety goggles when assembling the greenhouse.
- Follow the safety instructions of the tools you use for this assembly.
- In case of bad weather (rain, wind, thunderstorm, ...), do not set up your greenhouse.
- The greenhouse must be assembled by 2 people.
- Plastic bags and small components should be kept out of reach of children. Keep children away from the assembling area.
- Aluminium is a metal with electrical conductivity, keep aluminium profiles away from any electrical source.
- Not all heat-producing appliances (barbecue, torch, ...) can be stored in the greenhouse.
- The greenhouse must be positioned and fixed on a horizontal and even ground, not exposed to wind.
- Check the absence of networks (water, electricity, gas) underneath the installation site of the greenhouse.
- Beware, do not climb on the roof: risk of fall and serious injuries.
- In case of heavy snowfall, do not allow snow to accumulate on the roof.
- Do not bolt all the elements together permanently before the complete assembling of the product (except the greenhouse base). You can do so once the glass and panels are in place.

MAINTENANCE TIPS

- To clean your greenhouse, use clear soapy water.
- Do not use acetone, abrasive cleaners or other special detergents to clean the panels.
- Grease the door rail regularly.
- Clear the roof of snow and leaves.



CUSTOMER SERVICE

Website : www.sav-doviris.com

SOMMAIRE - INHALTSVERZEICHNIS - CONTENTS

1 Module de base 8,10 m² - pages 06 à 36
Basismodul 8,10 m² - Seiten 06 bis 36
Basic modul 8,10 m² - pages 06 to 36

2 Module de base 8,10 m² et extension 3,20 m² - pages 37 à 57
Basismodul 8,10 m² und Erweiterung 3,20 m² - Seiten 37 bis 57
Basic modul 8,10 m² and extension 3,20 m² - pages 37 to 57

3 Module de base 8,10 m² et extension 4,80 m² - pages 58 à 78
Basismodul 8,10 m² und Erweiterung 4,80 m² - Seiten 58 bis 78
Basic modul 8,10 m² and extension 4,80 m² - pages 58 to 78

SERRE - GEWÄCHSHAUS - GREENHOUSE

ALOÉ 8,10 M²

RÉFÉRENCES - ARTIKELNUMMERN - CODES :

● RAL 6009 : 788704

ALOÉ 3,20 M²

RÉFÉRENCES - ARTIKELNUMMERN - CODES :

● RAL 6009 : 794648

ALOÉ 4,80 M²

RÉFÉRENCES - ARTIKELNUMMERN - CODES :

● RAL 6009 : 794651

NUMÉRO DE TRAÇABILITÉ - RÜCKVERFOLGBARKEITSNUMMER - TRACEABILITY NUMBER











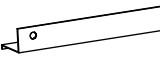
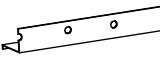
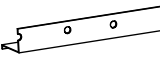
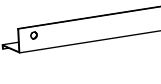
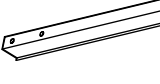







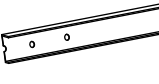
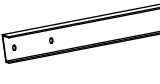
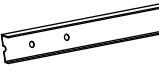
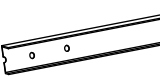
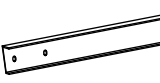
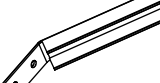









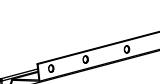
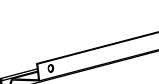
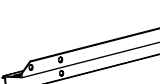
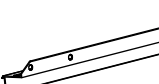
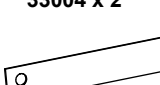
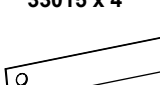
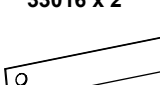
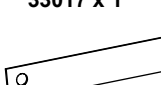
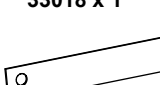
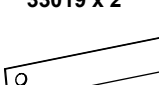
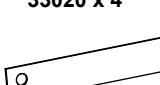
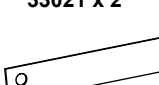

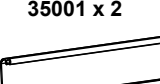

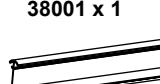
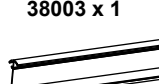
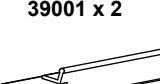

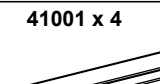

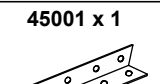
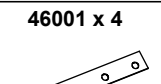
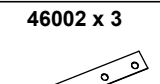
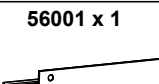
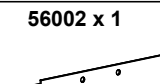
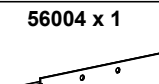
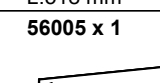
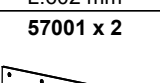

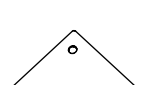
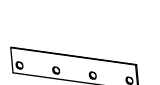
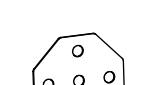
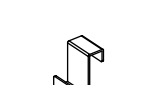

2020.11

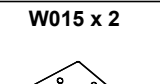
NOMENCLATURE - STÜCKLISTE - BILL OF MATERIALS

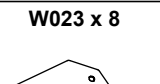
ALOÉ 8,10 M²

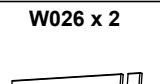











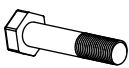



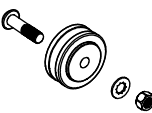

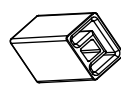
Colis - Paket - Parcel

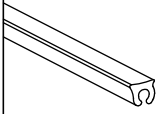
1/3 & 2/3



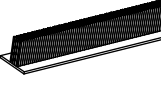
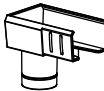

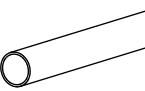



PROFILÉS ALUMINIUM - ALUMINIUMPROFILE - ALUMINIUM PROFILES							
01001 x 1  L:1241 mm	01002 x 1  L:1241 mm	01007 x 1  L:1862.5 mm	01008 x 1  L:1862.5 mm	01009 x 1  L:610 mm	01010 x 1  L:1874 mm	10003 x 2  L:1267 mm	15001 x 2  L:270 mm
18001 x 2  L:612 mm	20001 x 1  L:100 mm	21002 x 1  L:1991 mm	22002 x 1  L:1991 mm	23001 x 1  L:1235.5 mm	23002 x 1  L:1235.5 mm	23003 x 1  L:1235.5 mm	23004 x 1  L:1235.5 mm
23005 x 1  L:1857 mm	23006 x 1  L:1857 mm	24001 x 4  L:1160 mm	25002 x 8  L:1214 mm	25009 x 2  L:422 mm	25014 x 2  L:2030 mm	25015 x 2  L:2030 mm	25016 x 1  L:2030 mm
25017 x 8  L:1862 mm	27012 x 4  L:1214 mm	27013 x 2  L:1884 mm	27014 x 2  L:1884 mm	30002 x 1  L:1874 mm	30003 x 1  L:610 mm	32002 x 1  L:1250 mm	32003 x 1  L:1250 mm
33004 x 2  L:619 mm	33015 x 4  L:1658 mm	33016 x 2  L:1289 mm	33017 x 1  L:619 mm	33018 x 1  L:619 mm	33019 x 2  L:1680 mm	33020 x 4  L:1300 mm	33021 x 2  L:755 mm
34004 x 2  L:1991 mm	35001 x 2  L:621 mm	36001 x 2  L:621 mm	37001 x 4  L:621 mm	38001 x 1  L:1241 mm	38003 x 1  L:1862.5 mm	39001 x 2  L:634 mm	40001 x 2  L:602 mm
41001 x 4  L:518 mm	42001 x 2  L:602 mm	45001 x 1  L:400 mm	46001 x 4  L:250 mm	46002 x 3  L:200 mm	56001 x 1  L:1862.5 mm	56002 x 1  L:1862.5 mm	56004 x 1  L:1241 mm
56005 x 1  L:1241 mm	57001 x 2  L:400 mm	58001 x 4  L:18 mm					
PETITS COMPOSANTS - KLEINTEILE - SMALL COMPONENTS							
W002 x 2  L:1241 mm	W003 x 7  L:400 mm	W004 x 2  L:18 mm	W005 x 1  L:18 mm	W006 x 120  L:120 mm	W007 x 416  L:416 mm	W013 x 1  L:1241 mm	W014 x 4  L:400 mm
W015 x 2  L:400 mm	W016 x 1  L:18 mm	W023 x 8  L:18 mm	W024 x 12  L:12 mm	W026 x 2  L:26 mm	1001 x 281  M6	1002 x 257  M6 x 12 mm	1003 x 11  M6 x 8 mm

NOMENCLATURE - STÜCKLISTE - BILL OF MATERIALS

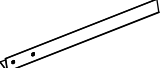
ALOÉ 8,10 M²

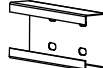
1004 x 32  M3.5 x 16 mm	1005 x 16  M3.5 x 6 mm	1006 x 2  M6 x 35 mm	1011 x 8  M6 x 14 mm	1012 x 2  M6 x 5 mm	1014 x 1  M6 x 18 mm	1015 x 4  Ø 6	2001 x 4 
2002 x 4 	2004 x 2 	2005 x 4 	2006 x 100m 	2009 x 2 	2010 x 2 	2018 x 2 	2021 x 2  L:1990 mm
2022 x 2 	2023 x 2 	2028 x 6 	2033 x 2  L:1040 mm	2038 x 2  L:38 mm			



BASE ET VISSERIE - FUNDAMENTRAHMEN UND SCHRAUBEN - GREENHOUSE BASE AND SCREWS



D007 x 4  1894 x 60 x 30 mm	D008 x 2  650 x 60 x 30 mm	D009 x 2  1272 x 60 x 30 mm	D011x 4 	D012 x 2 	D013 x 4 	D014 x 4 	1008 x 32 
1009 x 32  M6 x 12 mm	1010 x 32  M6	W008 x 21 					

Colis - Paket - Parcel

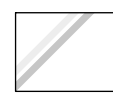
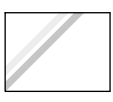
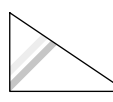
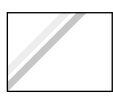
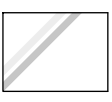
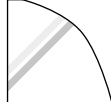
3/3

VERRES - GLÄSER - GLAZING

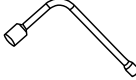
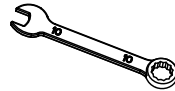
1 x 40  610 x 610 mm	4 x 6  610 x 229 mm	5 x 2  600 x 544 mm	11 x 4  610 x 434/8 mm	16 x 8  610 x 549 mm	26 x 20  610 x 375 mm	27 x 4  610 x 610 mm	PC18 x 10  610 x 610 mm
--	---	---	--	--	---	--	---

OUTILS INCLUS VORHANDENE WERKZEUGE TOOLS INCLUDED		NON INCLUS NICHT VORHANDEN NOT INCLUDED	
 M6/10 mm	 M6/10 mm		 10 m

MONTAGE BASE - MONTAGE FUNDAMENTRAHMEN - BASE ASSEMBLING

Il est impératif que la base soit montée de niveau.



Es ist zwingend erforderlich, dass der Fundamentrahmen auf einer geraden Ebene montiert wird.

It is imperative that the greenhouse base is leveled.

Module de base
Basismodul
Basic module

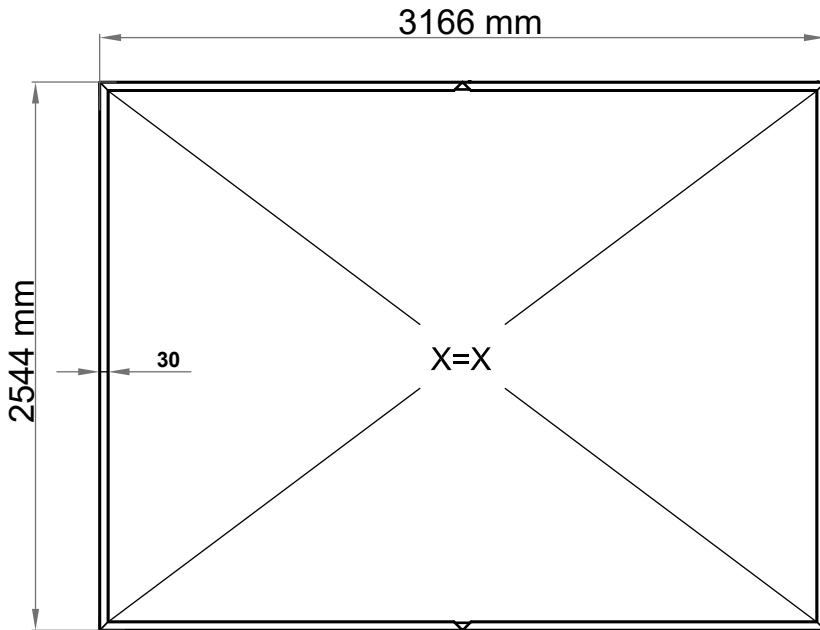

FACE AVANT (AVEC PORTE)
VORDERWAND (MIT TÜR)
FRONT WALL (WITH DOOR)

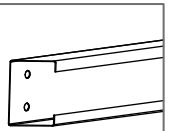
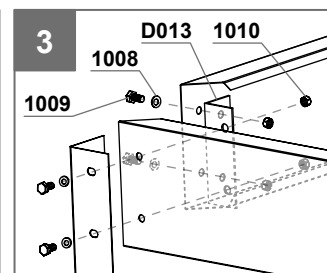
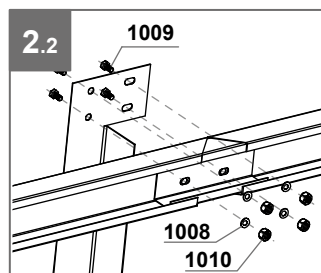
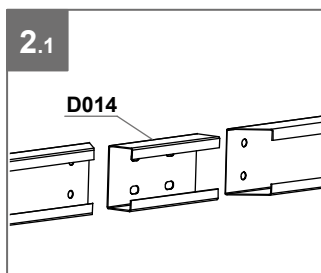
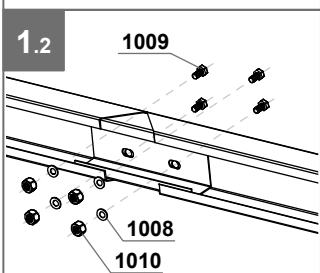
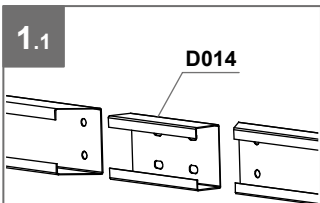
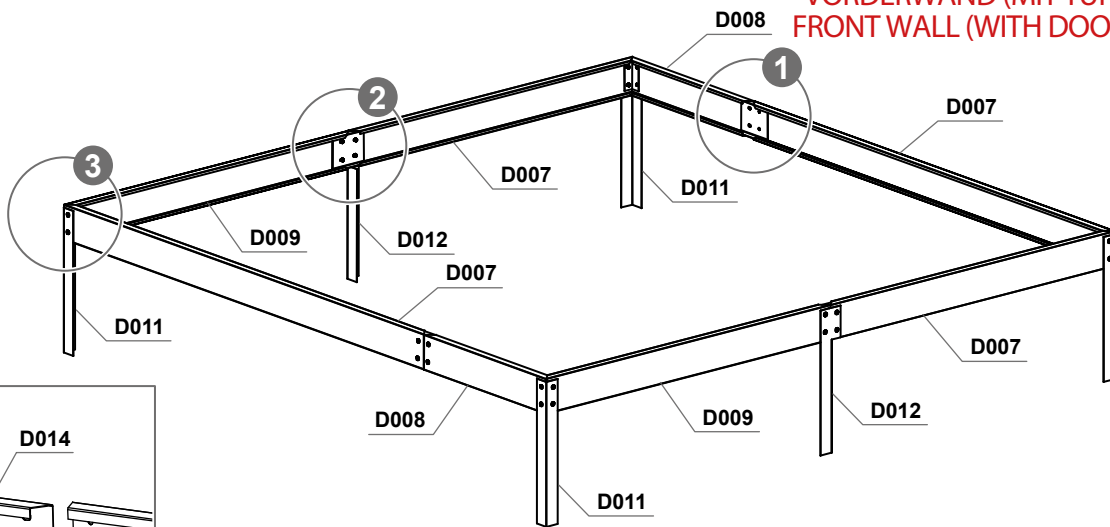

D007 x 4

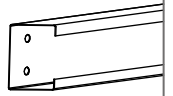

D008 x 2

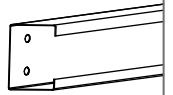

D009 x 2

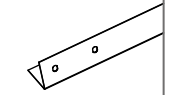

D011 x 4

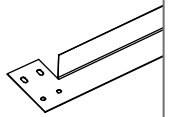

D012 x 2

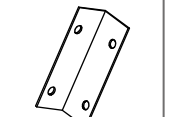

D013 x 4

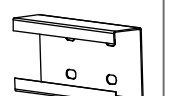

D014 x 4

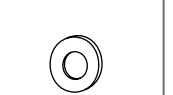

1008 x 32

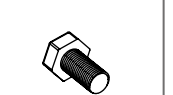

1009 x 32



1010 x 32



FIXATION DE LA BASE AU SOL

FIXATION EN PLEINE TERRE

- Positionner la base à l'endroit voulu, de niveau sur un sol damé.
- Repérer et marquer l'emplacement des pattes de scellement suivant le schéma ci-dessous.
- Sous les quatre pieds marquer un carré de 300 x 300 mm et creuser sur une profondeur de 450 mm
- Placer la base, la mettre de niveau mais **ATTENTION**, ne pas remplir les trous avant le montage complet de la serre.

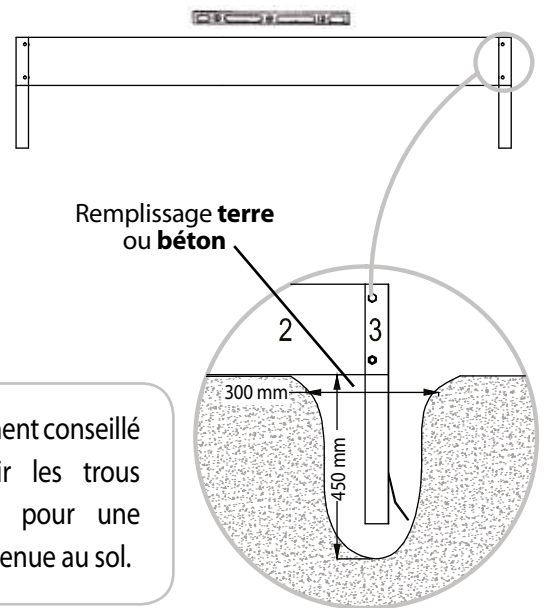
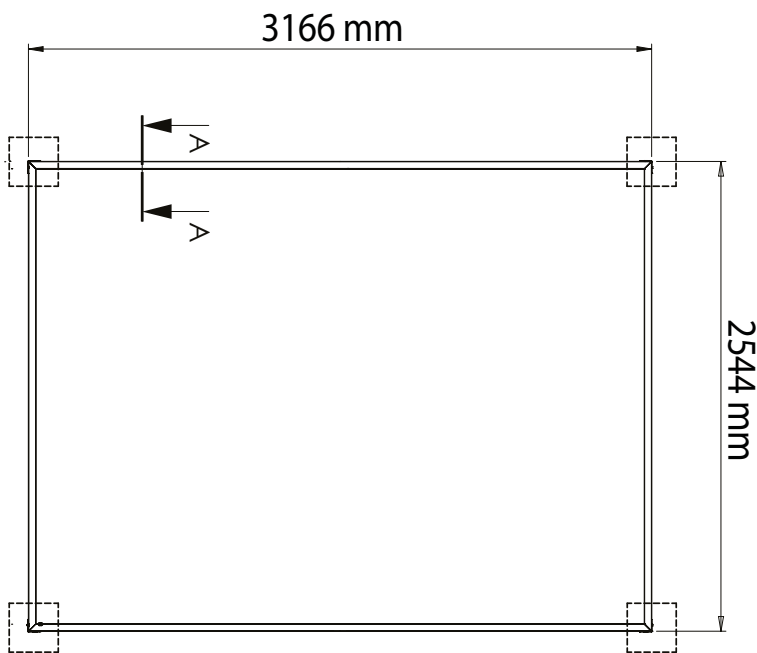

Il est vivement conseillé de remplir les trous de béton pour une meilleure tenue au sol.

OU

FIXATION SUR DALLE BÉTON

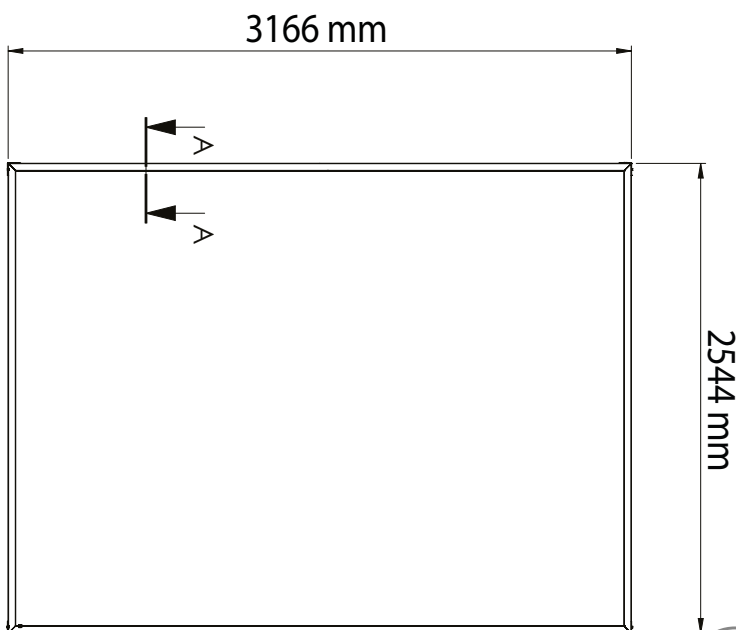

Détail A-A

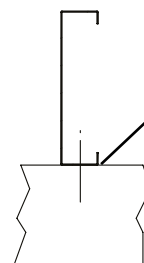

Fixation par chevilles à l'intérieur de la base



Visseries et chevilles de fixation non fournies

Il est laissé à votre libre choix et décision, l'utilisation des fixations adéquats selon les supports que vous décidez d'utiliser (pourtour bois, parpaings, plaques ciment, ...).



BEFESTIGUNG DES FUNDAMENTRAHMENS AM BODEN

BEFESTIGUNG AUF ERDBODEN (Punktfundament)

- Stellen Sie den Fundamentrahmen an der gewünschten Stelle, ebenerdig, auf einem gefüllten Boden.
- Orten und markieren Sie die Stelle der Ankerbeine gemäß dem untenstehenden Schema.
- Unter den vier Beinen ein 300 x 300 mm Quadrat kennzeichnen und 450 mm tief graben.
- Den Fundamentrahmen platzieren und nivellieren, aber **ACHTUNG**, die Löcher erst füllen, wenn das Gewächshaus komplett montiert ist.

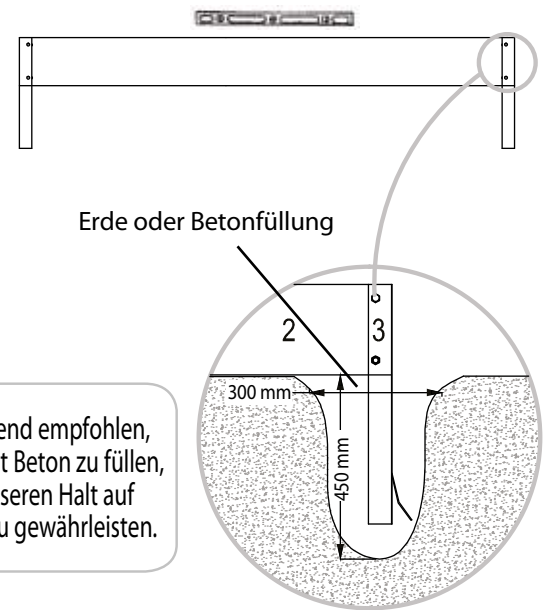
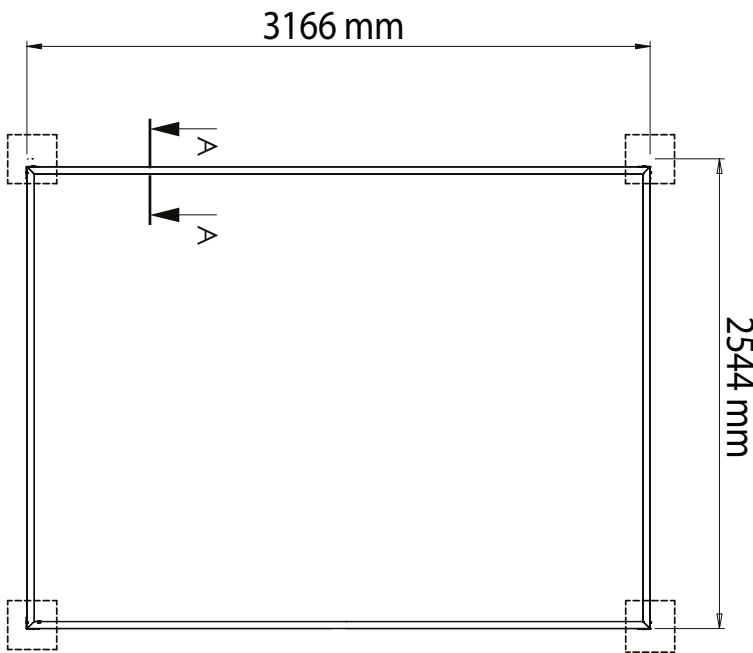

Es wird dringend empfohlen, die Löcher mit Beton zu füllen, um einen besseren Halt auf dem Boden zu gewährleisten.

ODER

BEFESTIGUNG AUF BETONDECKE (Streifenfundament)

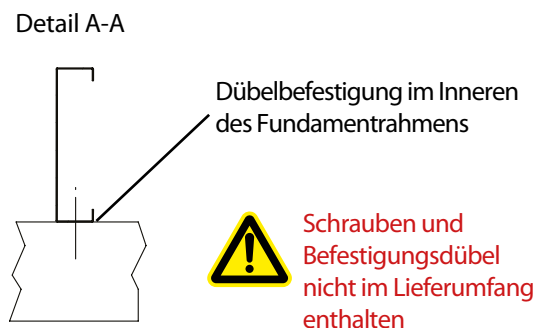
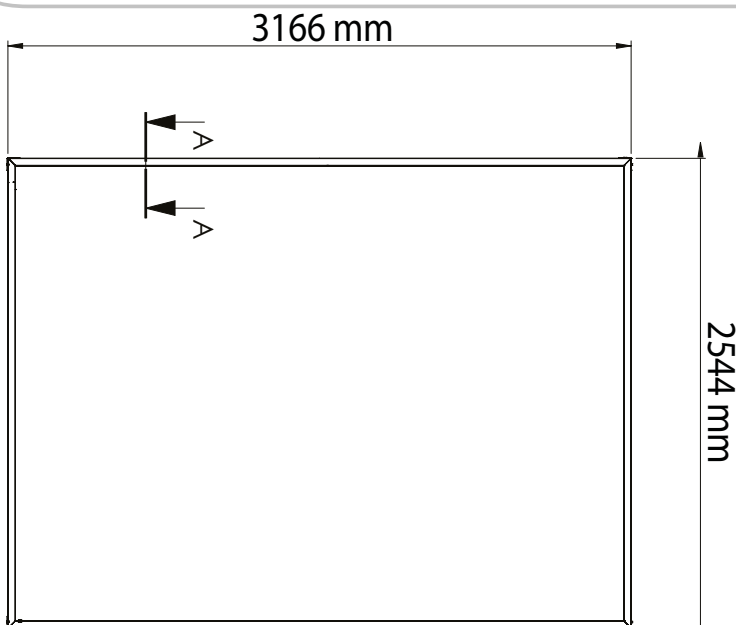

Es bleibt Ihrer freien Wahl und Entscheidung überlassen, die geeigneten Befestigungsmittel entsprechend der von Ihnen gewählten Träger (Holzumrandung, Bausteine, Zementplatten,...) zu verwenden.



FIXING THE GREENHOUSE BASE TO THE GROUND

FIXING ON SOIL

- Position the greenhouse base in the desired location at a level position on a filled floor.
- Locate and mark the location of the base legs as shown bellow.
- Under the four legs, mark a square of 300 x 300 mm and dig to a depth of 450 mm.
- Place the GREENHOUSE BASE, level it but CAUTION, do not fill the holes before the complete assembly of the greenhouse.

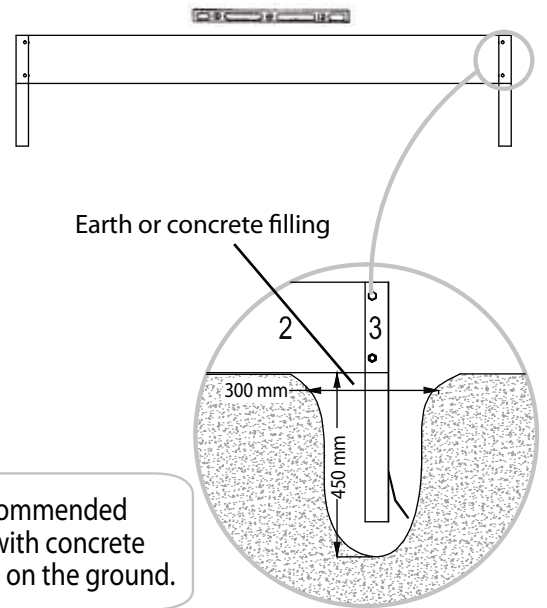
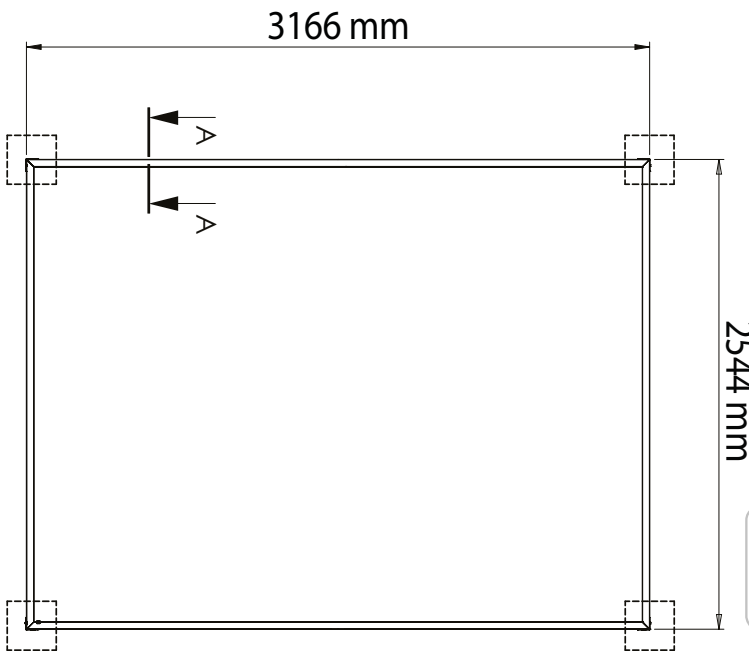

It is strongly recommended to fill the holes with concrete for a better hold on the ground.

OR

FIXING ON CONCRETE SLAB

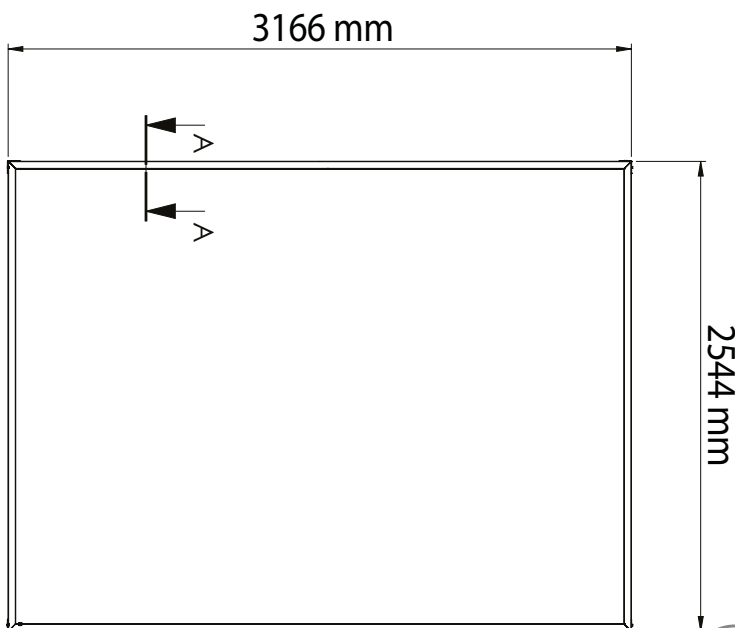

Detail A-A

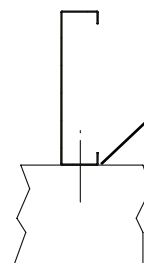

Rawplug fastening inside the greenhouse base



Screws and rawplugs not provided

It remains to your free choice and decision to use the suitable fastening means according to the supports you chose (wood border, building stones, cement plates etc.)

VIS 1002 & 1003 - SCHRAUBEN 1002 & 1003 - SCREWS 1002 & 1003

Mise en place des vis 1002 et 1003 dans les rainures en forme de T des profilés aluminium :
Entrez la tête de vis dans la rainure du profilé et tournez à 90° afin qu'elle ne puisse pas sortir du profilé. Assemblez la/les pièce(s) nécessaire(s) et serrez l'écrou.

Verwendung der Schrauben 1002 und 1003 in den T-förmigen Nuten der Aluminiumprofile :
Schraubenkopf in die Profilmutter stecken und diesen um 90° drehen, damit er nicht aus dem Profil herauskommt. Bauen Sie das/die benötigte(n) Einzelteil(e) zusammen und ziehen Sie die Schraubenmutter an.

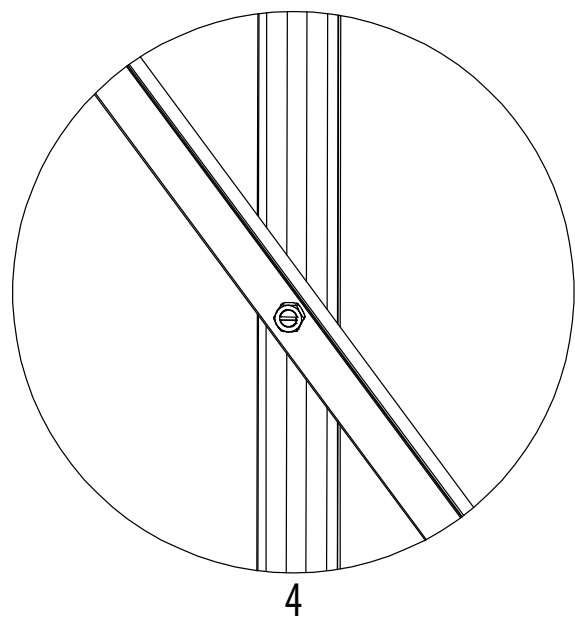
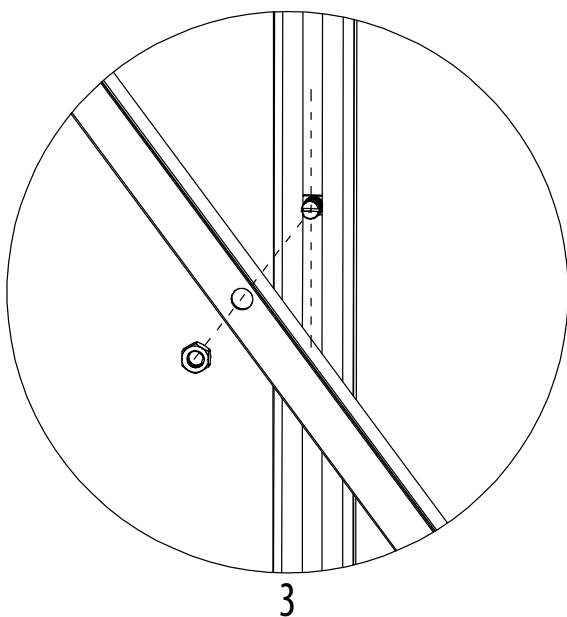
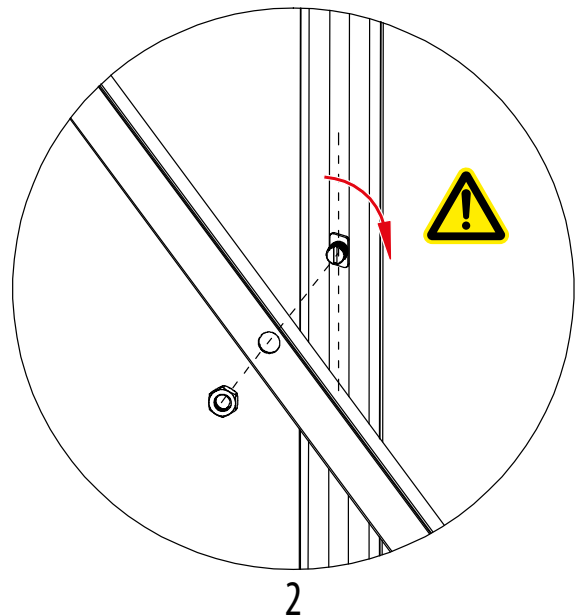
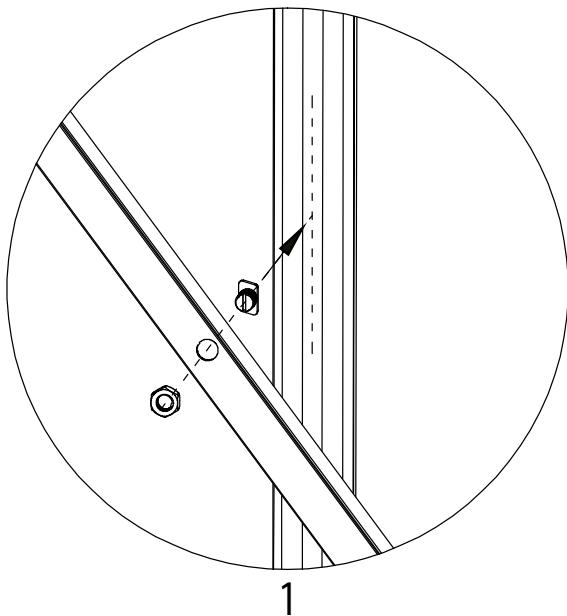

Principle of use of screws 1002 and 1003 in the T-shaped grooves of the aluminium profiles :
Enter the screw head into the groove of the profile and turn the screw head at 90° so that it cannot exit the profile. Assemble the required part(s) and tighten the screw nut.

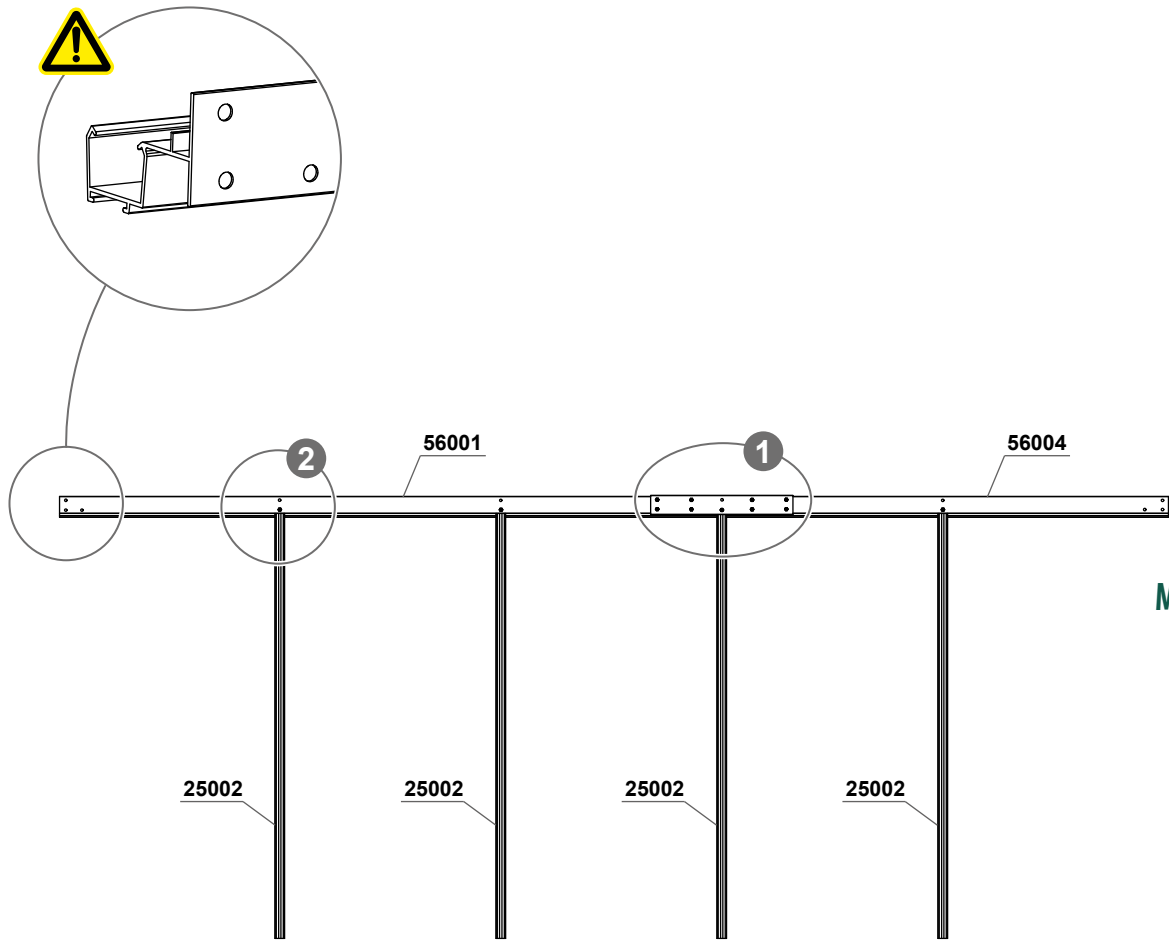

LONG-PAN (CÔTÉ) A1 - SEITENWAND A1 - SIDE WALL A1

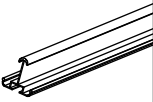
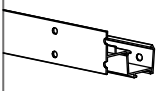
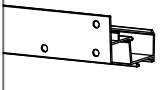
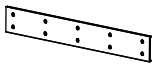
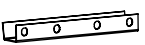

Module de base Basismodul Basic module

-  25002 x 4
-  56001 x 1
-  56004 x 1
-  57001 x 1
-  W002 x 1
-  1001 x 16
-  1002 x 16

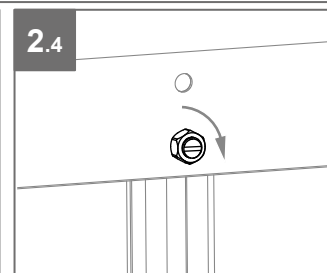
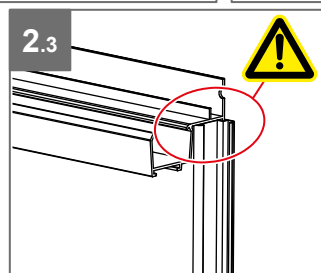
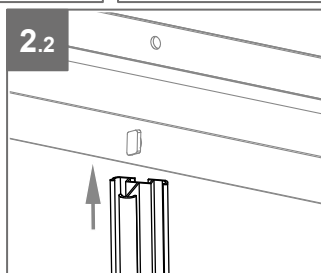
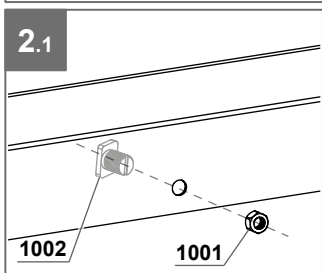
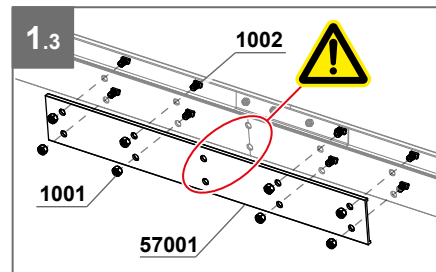
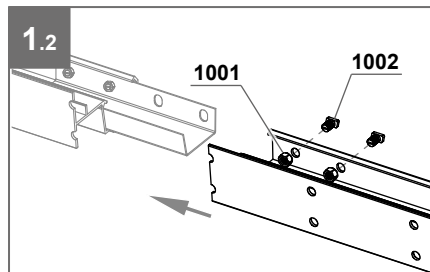
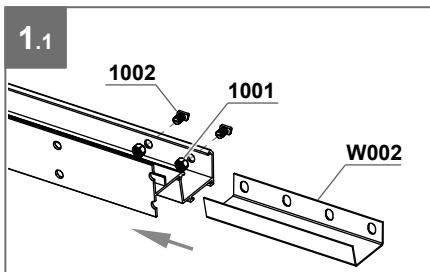

LONG-PAN (CÔTÉ) A1 - SEITENWAND A1 - SIDE WALL A1

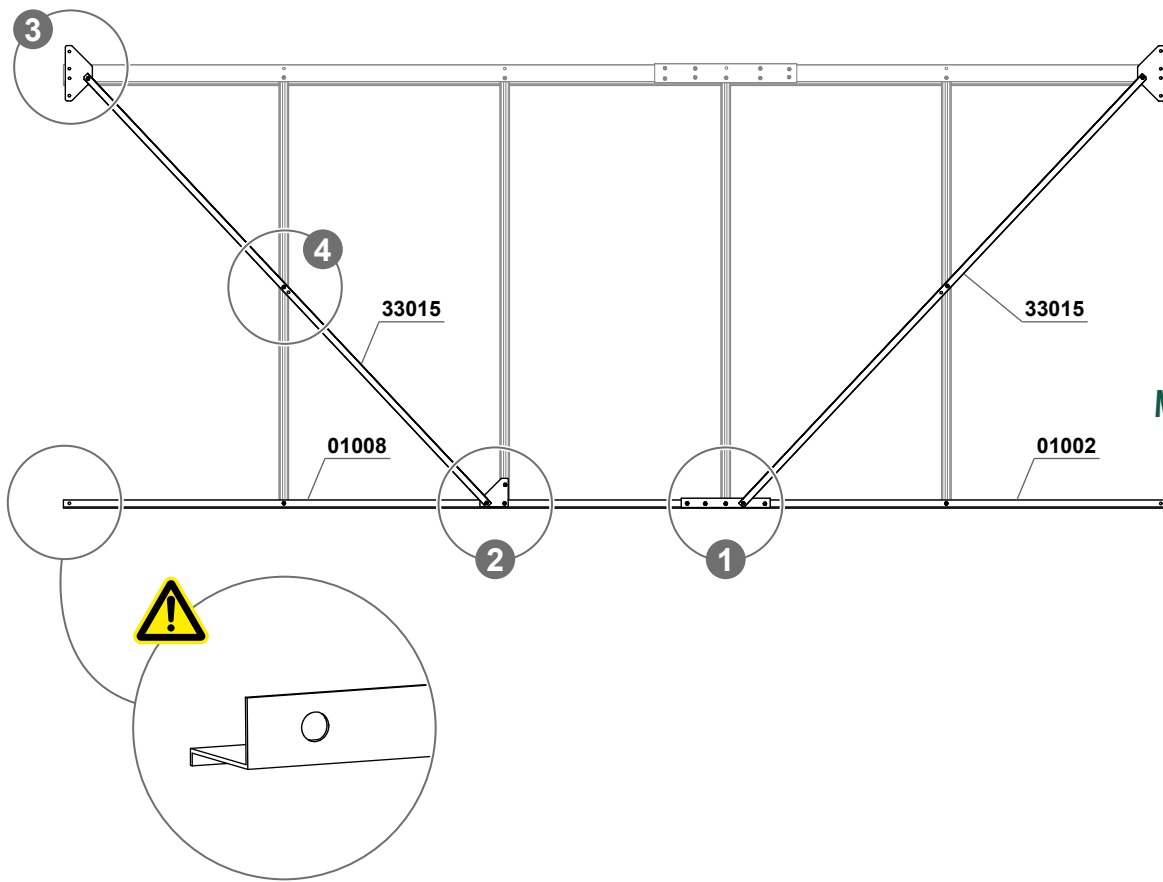

Module de base Basismodul Basic module

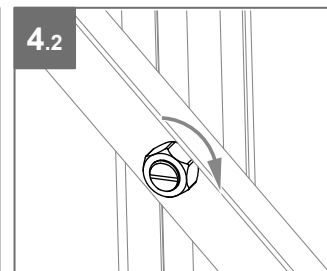
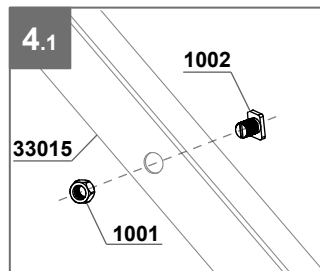
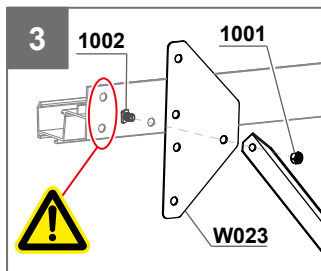
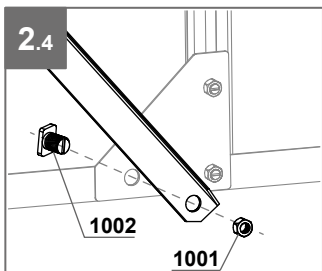
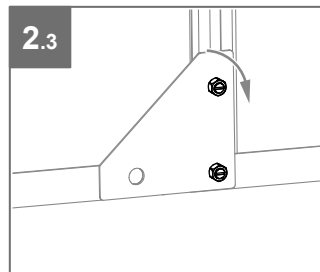
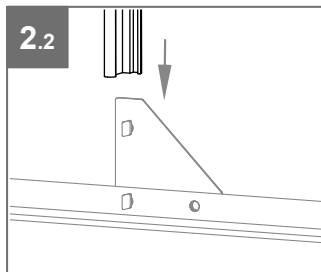
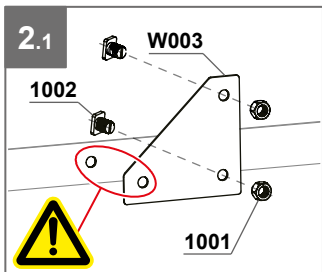
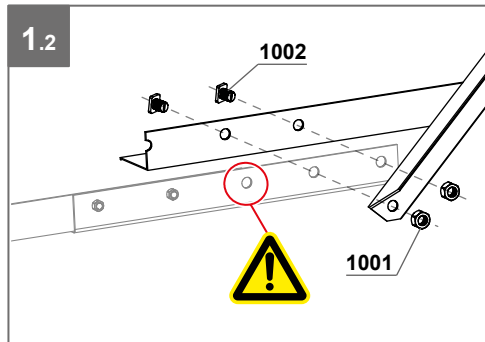
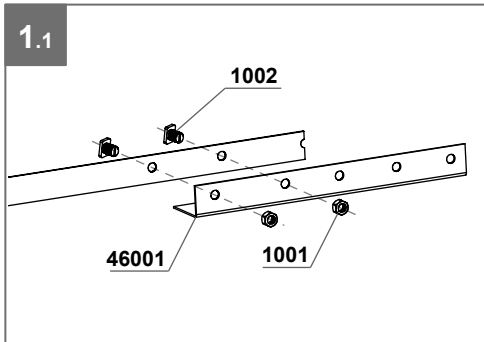

	01002 x 1
	01008 x 1
	33015 x 2
	46001 x 1
	1001 x 14
	1002 x 14
	W003 x 1
	W023 x 2

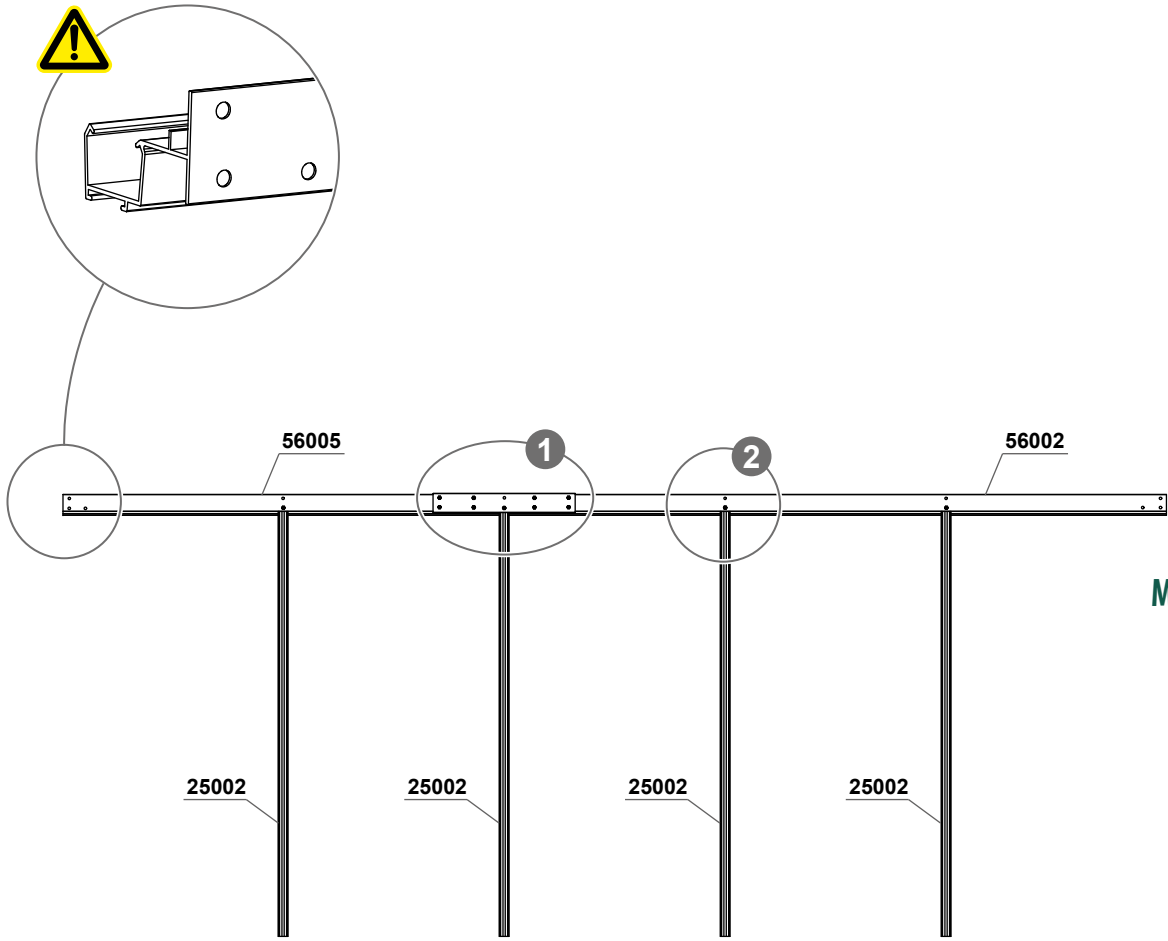

LONG-PAN (CÔTÉ) A2 - SEITENWAND A2 - SIDE WALL A2

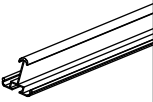
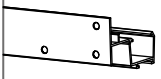
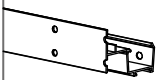
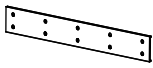
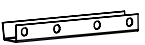

Module de base Basismodul Basic module

-  25002 x 4
-  56002 x 1
-  56005 x 1
-  57001 x 1
-  W002 x 1
-  1001 x 16
-  1002 x 16

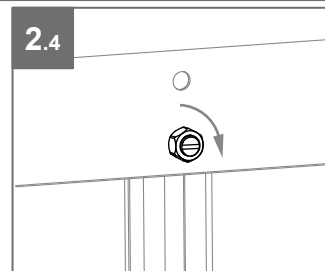
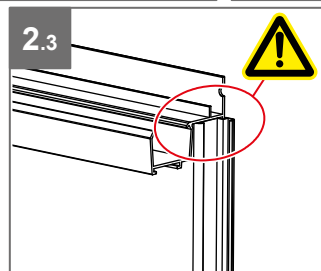
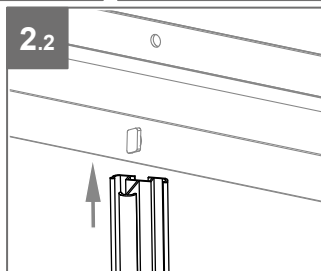
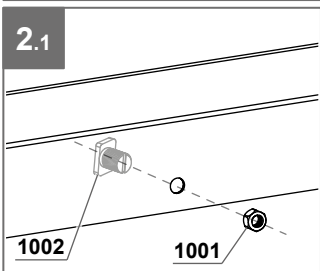
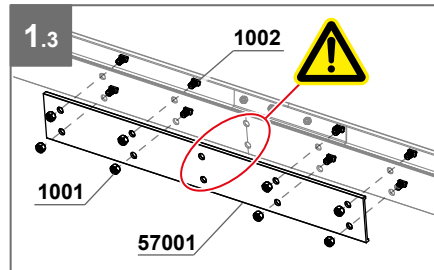
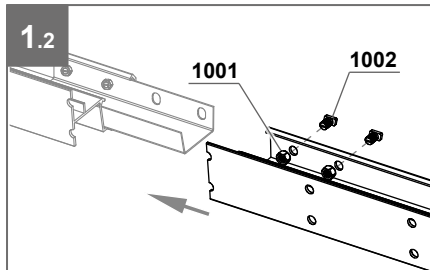
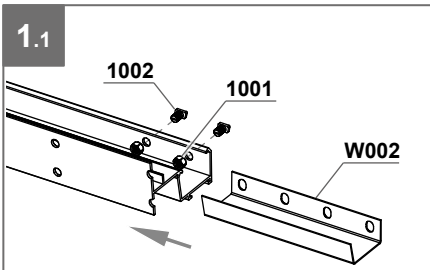

LONG-PAN (CÔTÉ) A2 - SEITENWAND A2 - SIDE WALL A2

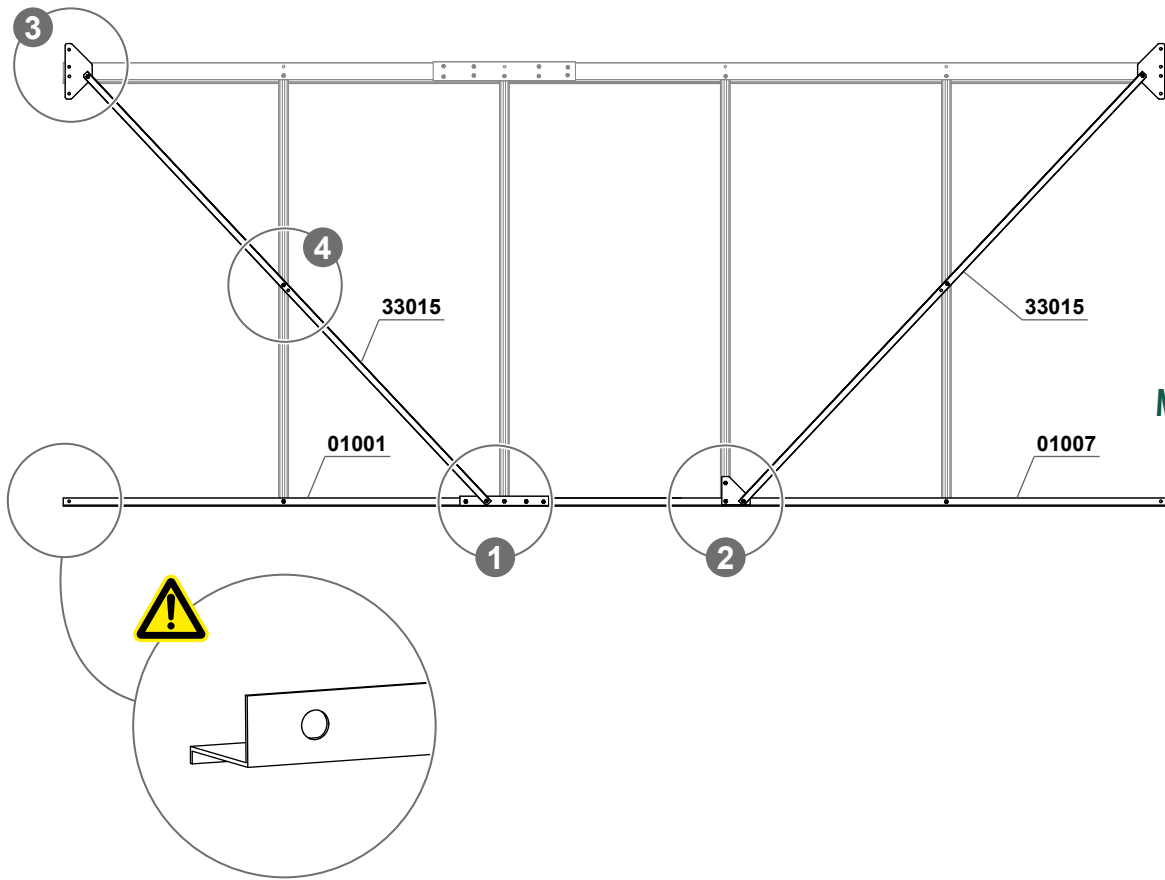

Module de base
Basismodul
Basic module

	01001 x 1
	01007 x 1
	33015 x 2
	46001 x 1
	1001 x 14
	1002 x 14
	W003 x 1
	W023 x 2

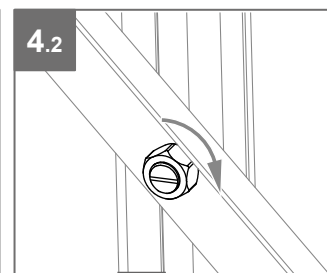
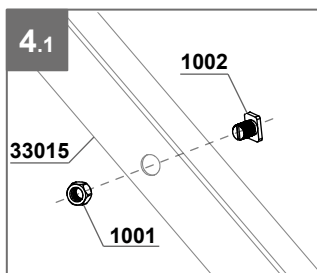
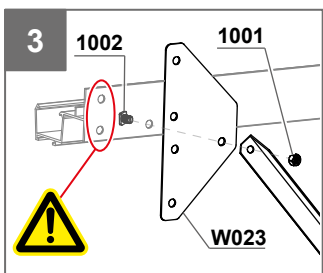
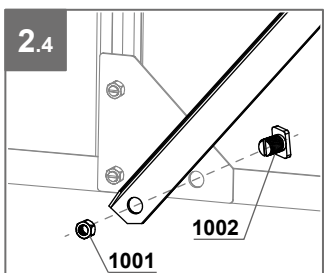
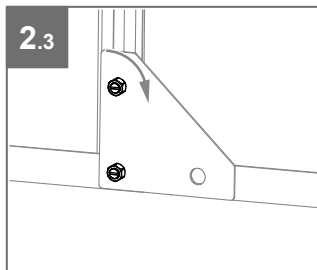
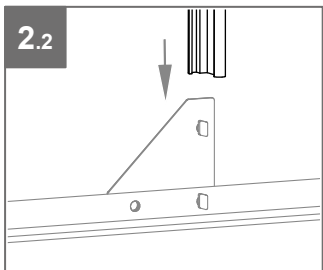
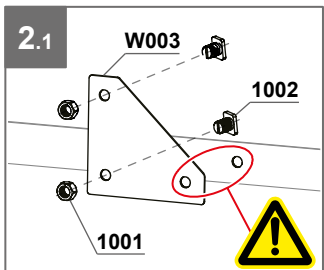
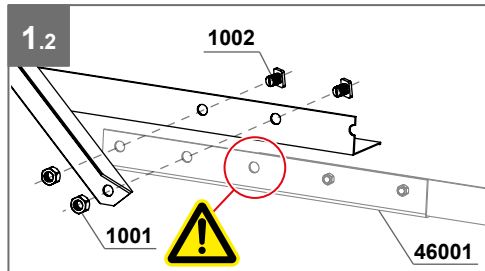
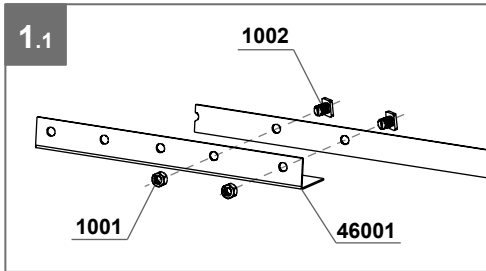

FACE AVANT (AVEC PORTE) - VORDERWAND (MIT TÜR) FRONT WALL (WITH DOOR)

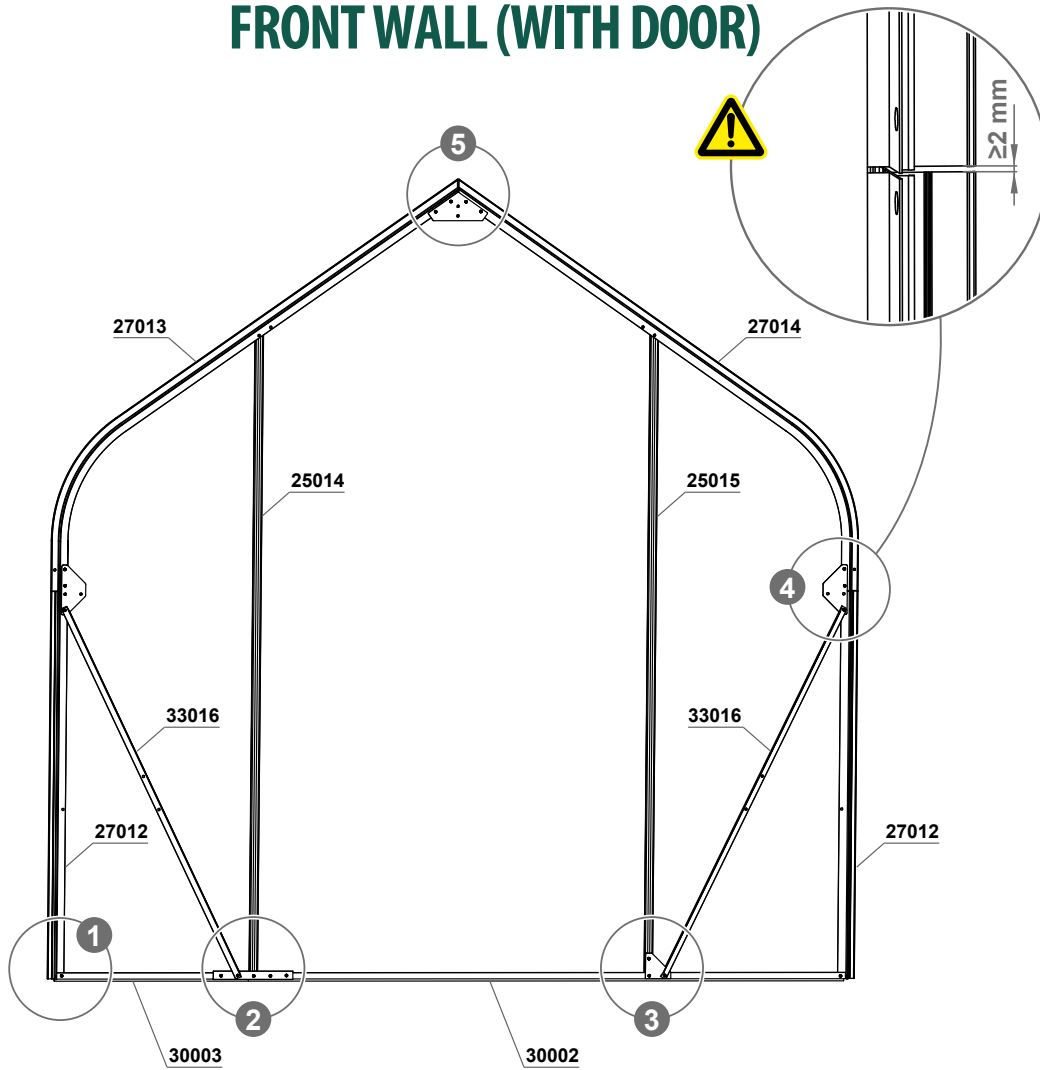

	30002 x 1
	30003 x 1
	27012 x 2
	27013 x 1
	27014 x 1
	25014 x 1
	25015 x 1
	33016 x 2
	46001 x 1
	W003 x 1
	W015 x 1
	W023 x 2
	1001 x 20
	1002 x 20

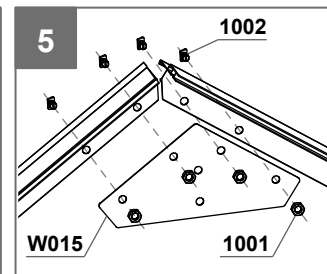
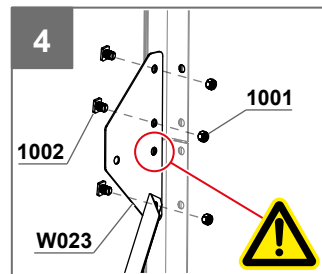
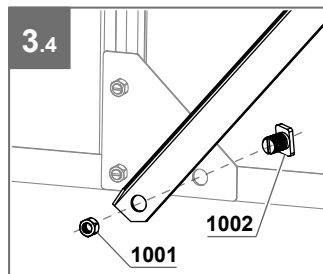
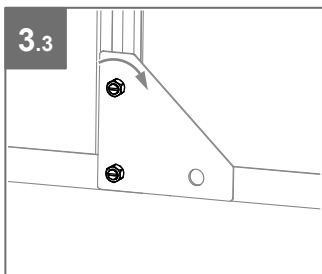
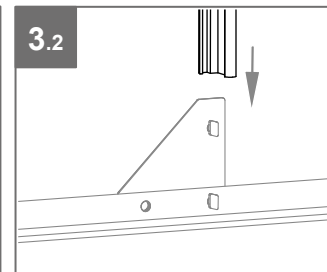
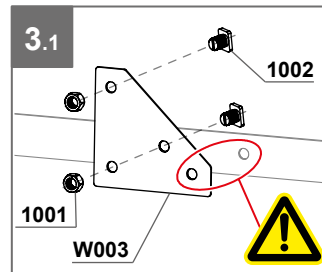
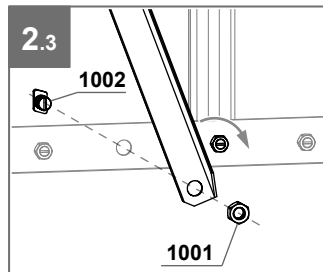
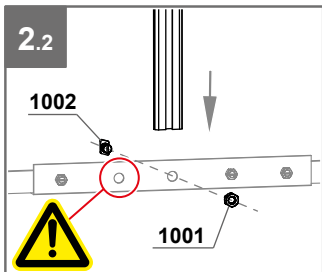
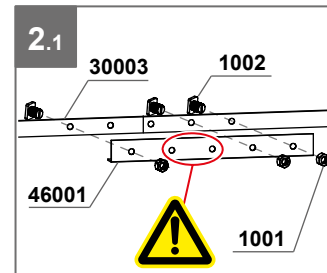
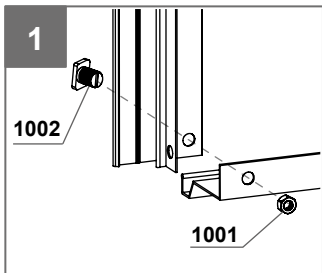

FACE AVANT (AVEC PORTE) - VORDERWAND (MIT TÜR) FRONT WALL (WITH DOOR)

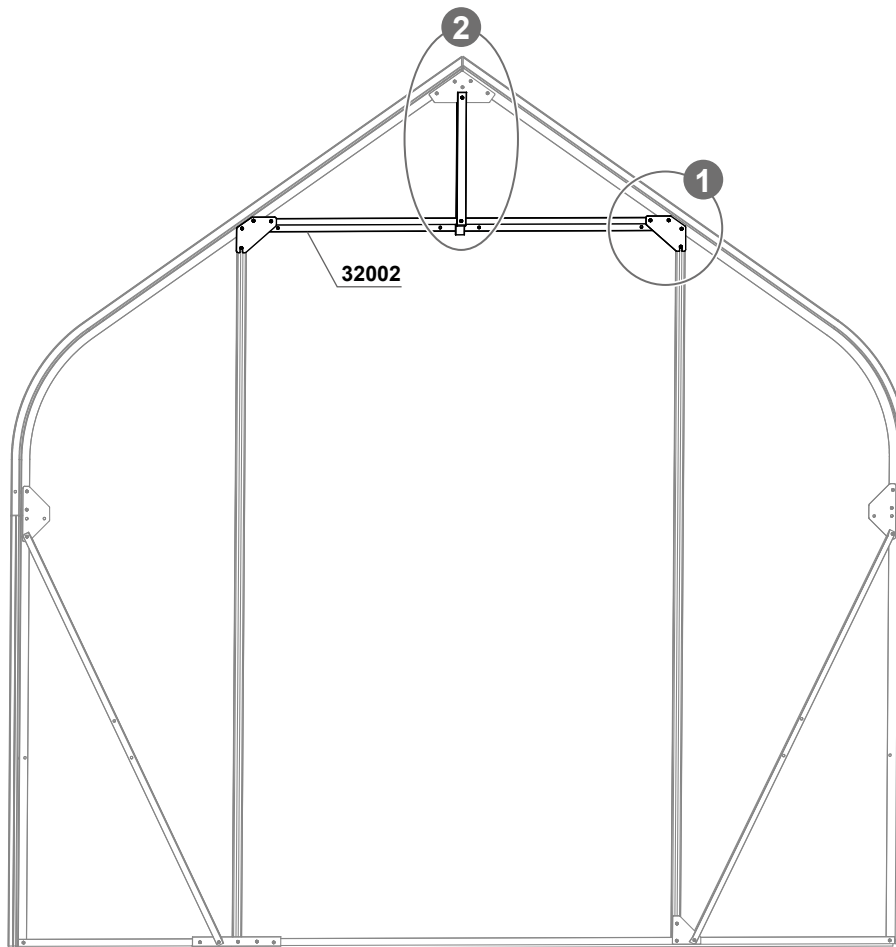

Module de base Basismodul Basic module

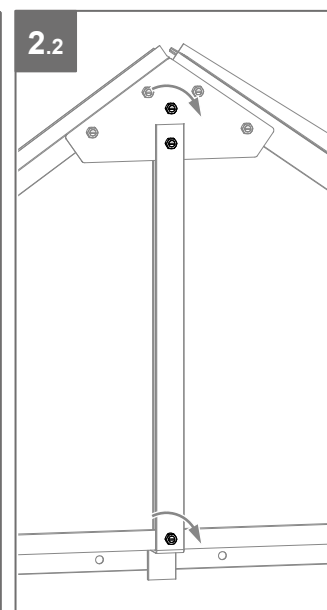
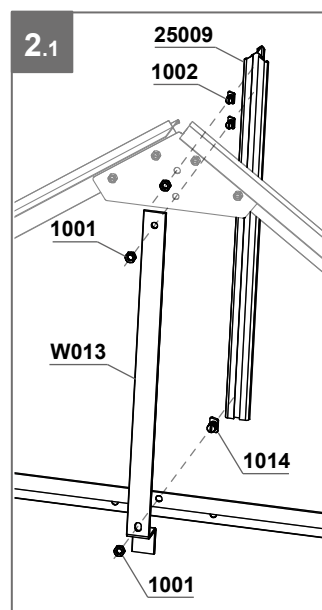
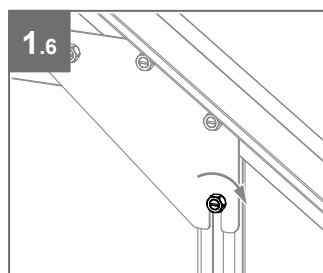
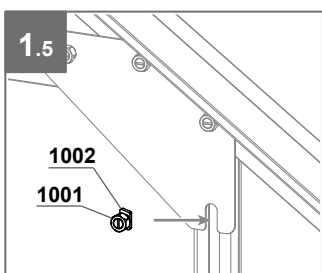
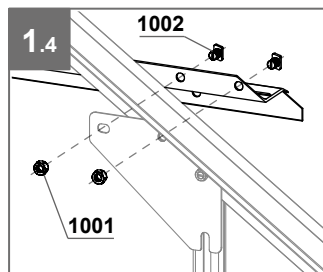
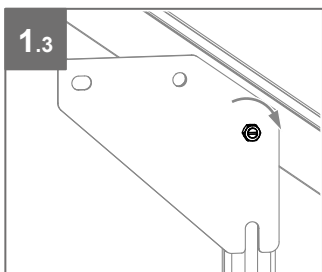
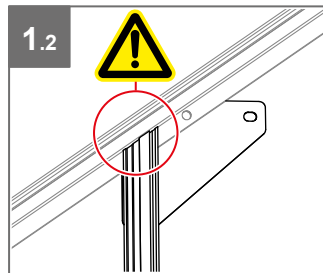
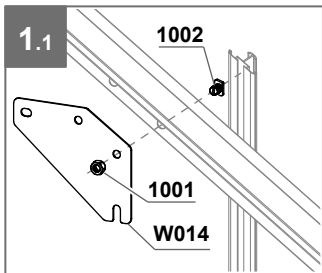
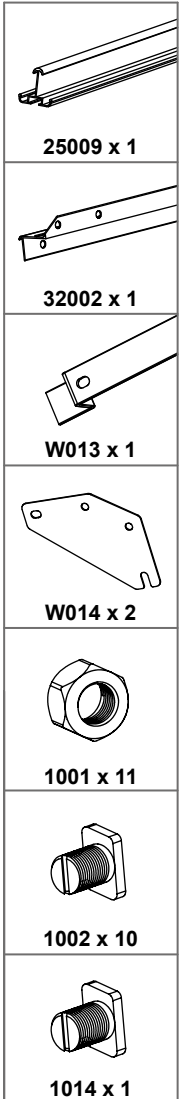

FACE AVANT (AVEC PORTE) - VORDERWAND (MIT TÜR) FRONT WALL (WITH DOOR)

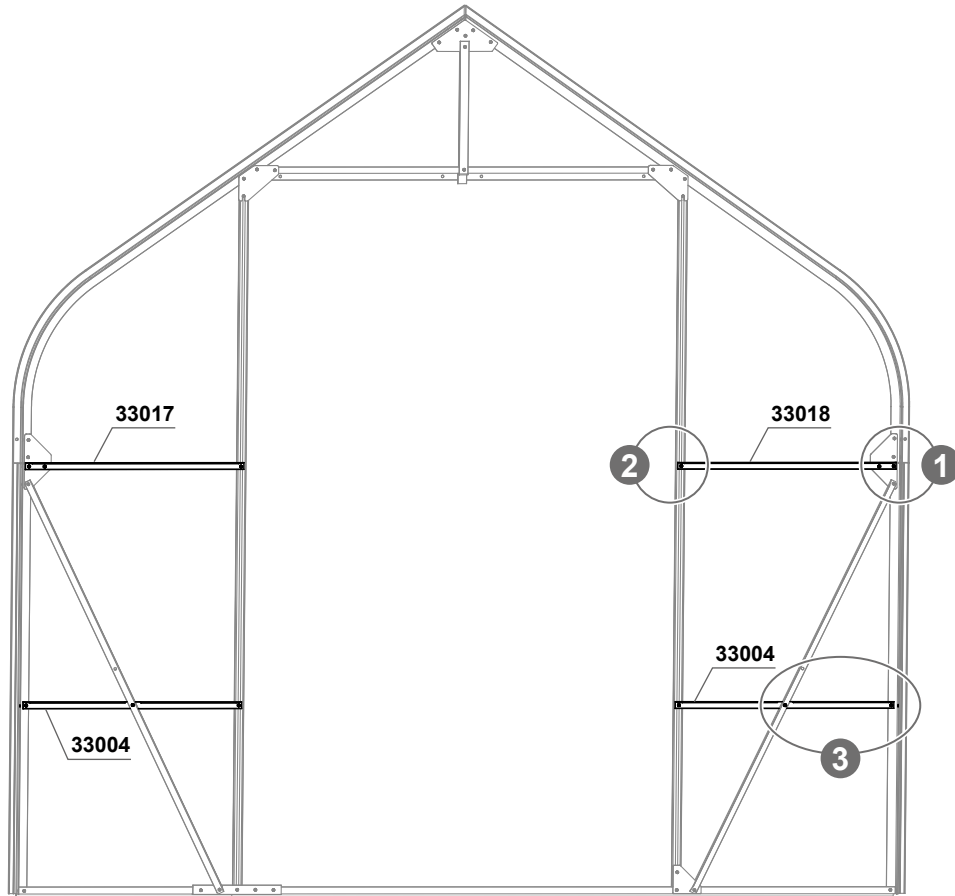

Module de base Basismodul Basic module

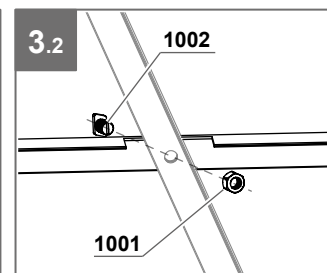
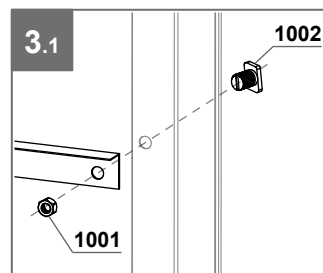
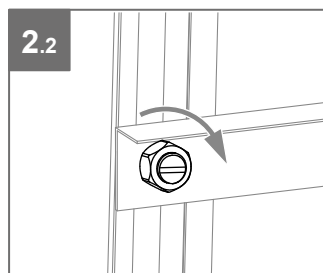
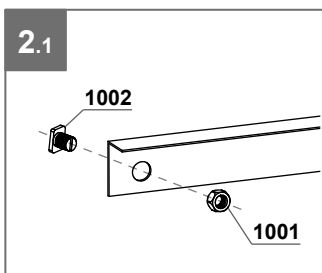
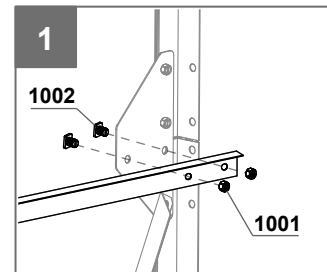
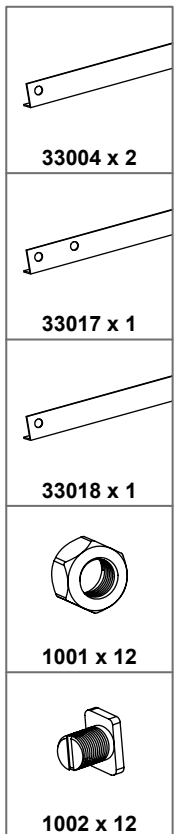

FACE ARRIÈRE (SANS PORTE) - RÜCKWAND (OHNE TÜR) REAR WALL (WITHOUT DOOR)

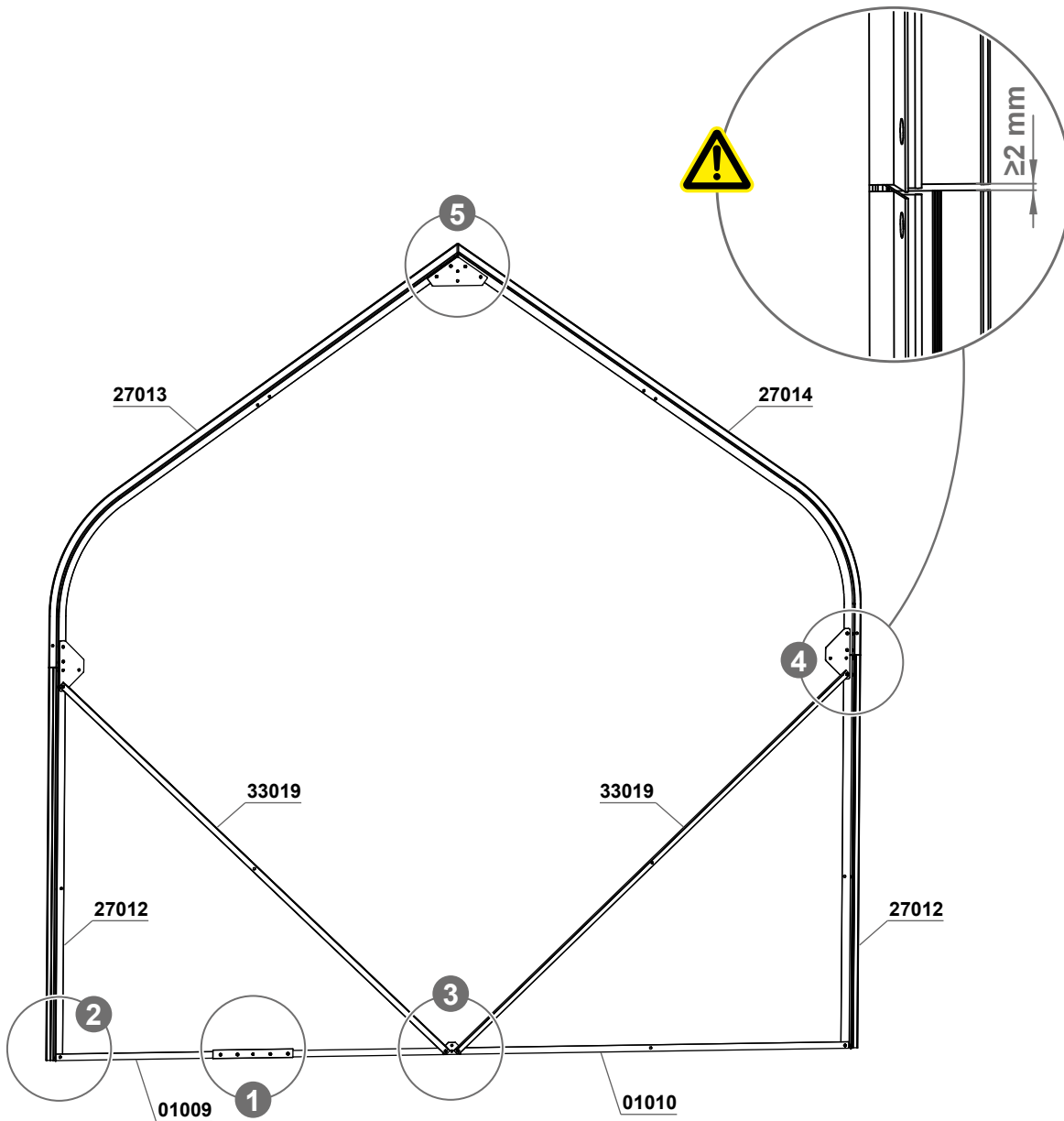

Module de base Basismodul Basic module

	01009 x 1
	01010 x 1
	27012 x 2
	27013 x 1
	27014 x 1
	33019 x 2
	46001 x 1
	W005 x 1
	W015 x 1
	W023 x 2
	1001 x 18
	1002 x 18

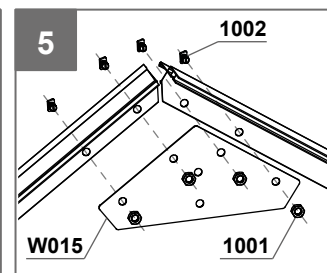
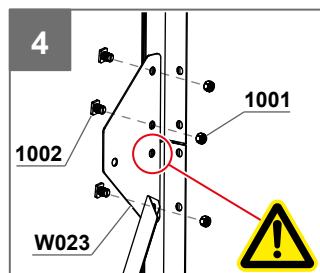
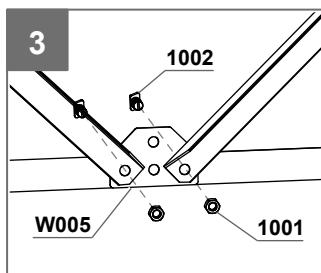
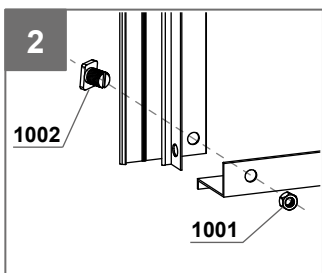
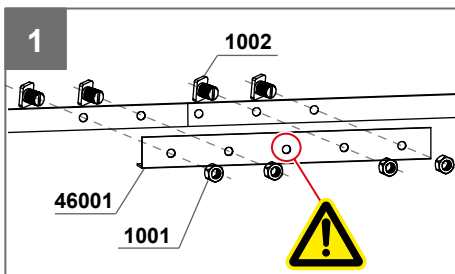



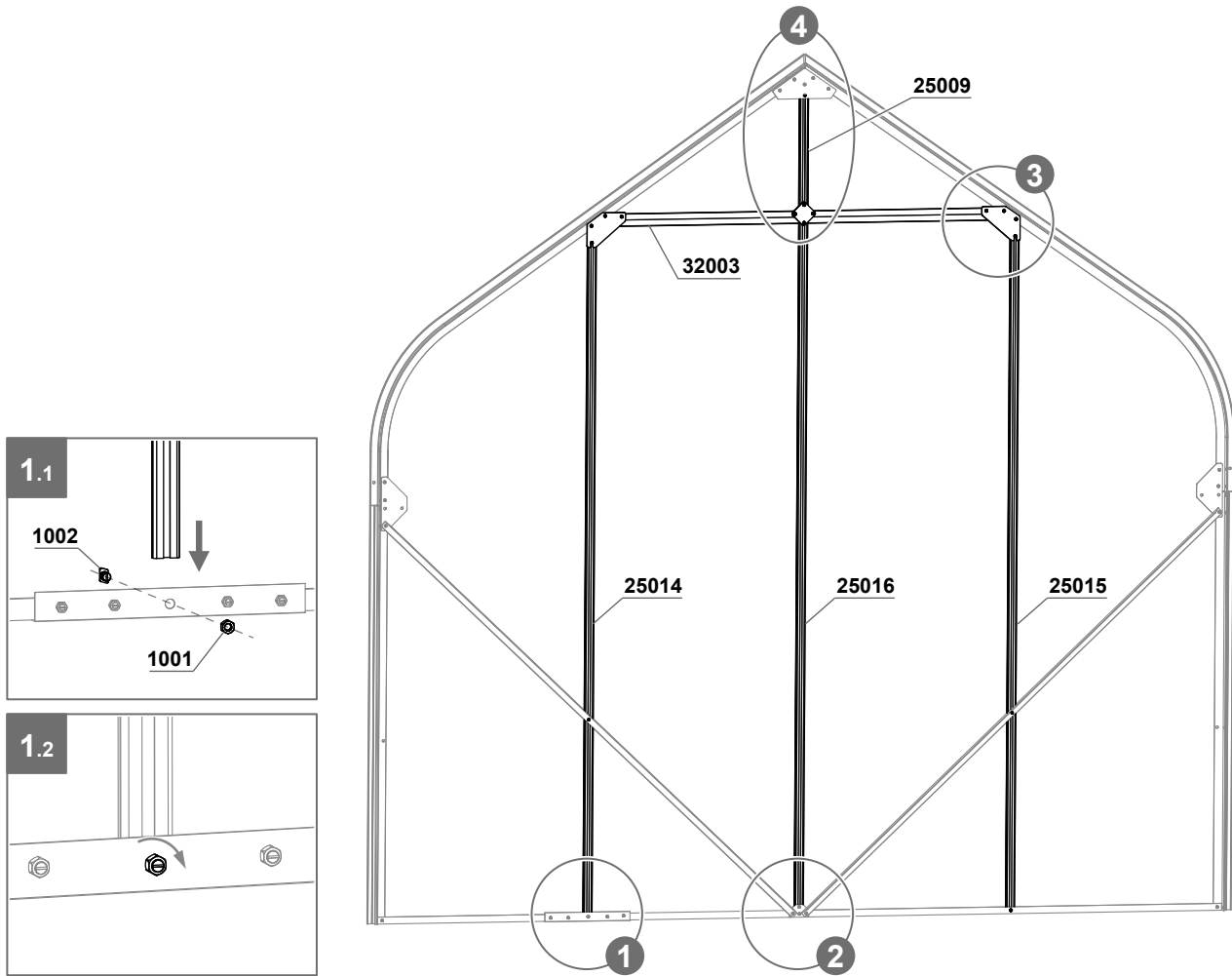

FACE ARRIÈRE (SANS PORTE) - RÜCKWAND (OHNE TÜR) REAR WALL (WITHOUT DOOR)

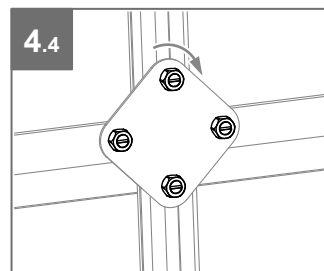
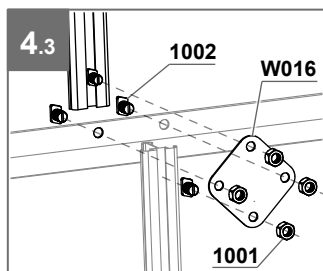
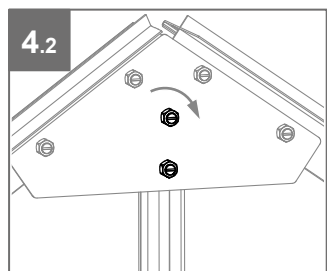
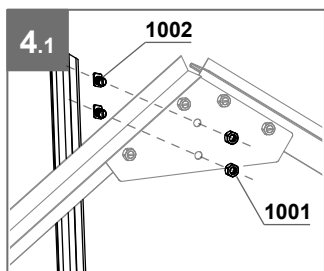
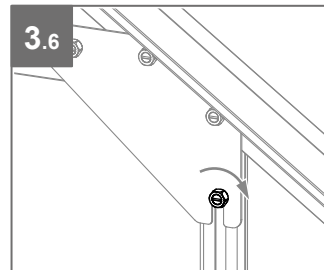
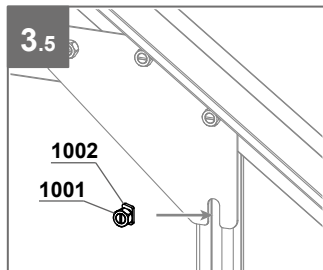
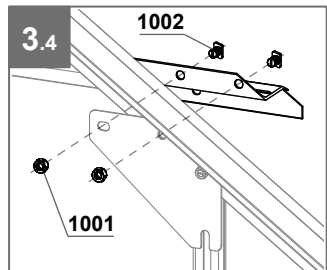
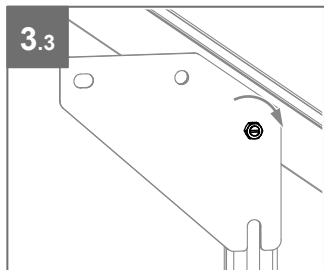
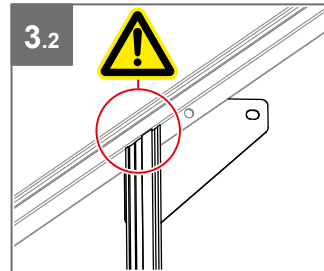
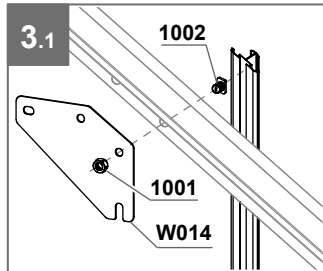
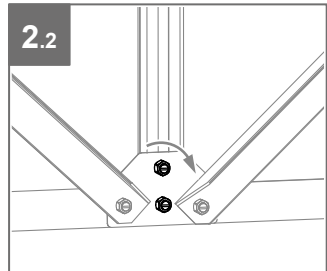
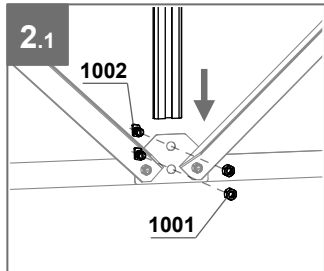
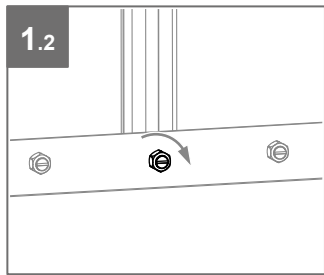
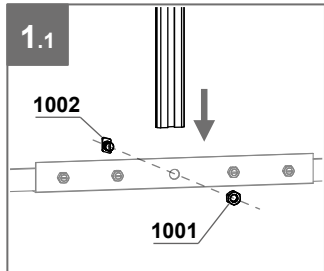

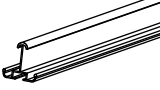
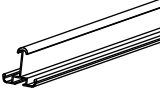
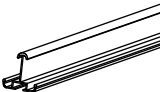
Module de base
Basismodul
Basic module

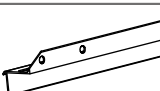
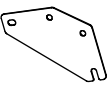
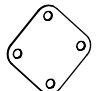

-  25009 x 1
-  25014 x 1
-  25015 x 1
-  25016 x 1
-  32003 x 1
-  W014 x 2
-  W016 x 1
-  1001 x 18
-  1002 x 18

FACE ARRIÈRE (SANS PORTE) - RÜCKWAND (OHNE TÜR) REAR WALL (WITHOUT DOOR)

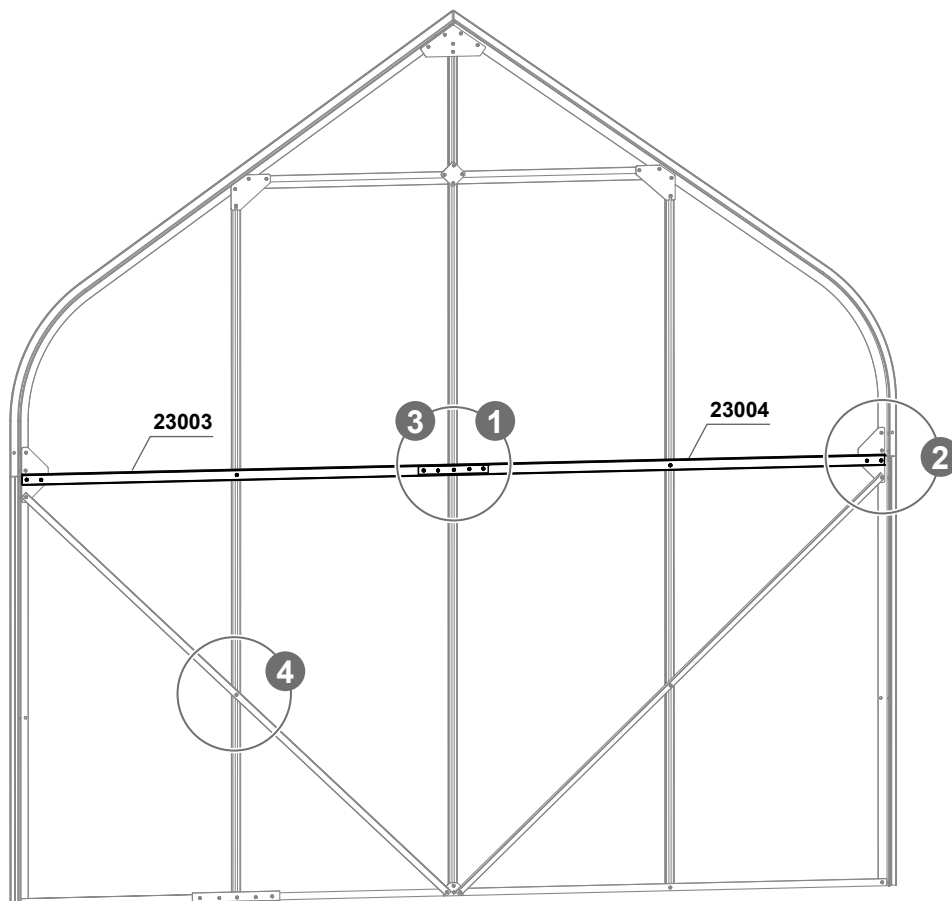

Module de base Basismodul Basic module

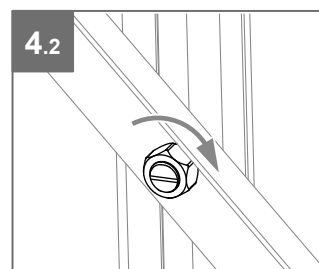
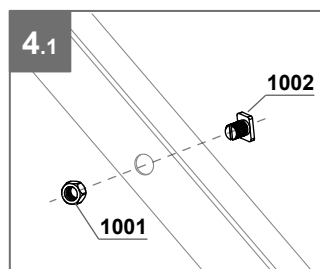
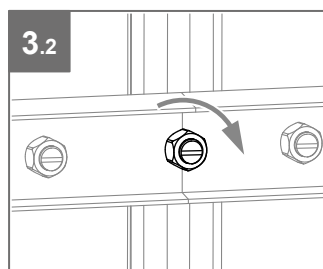
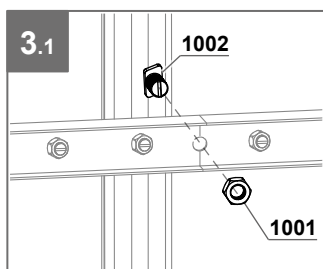
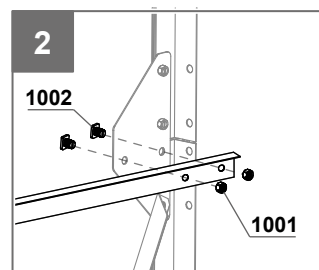
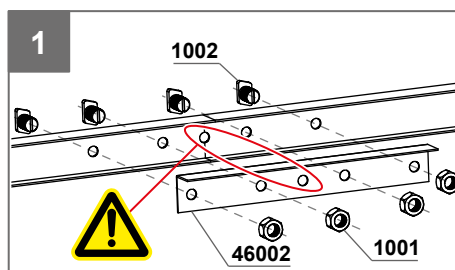
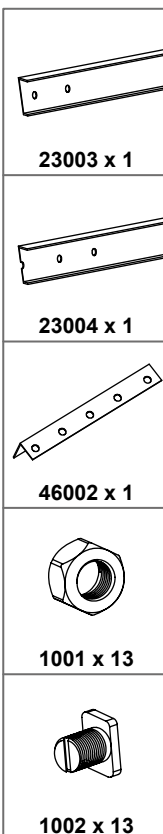

PORTE GAUCHE - LINKE TÜR LEFT DOOR

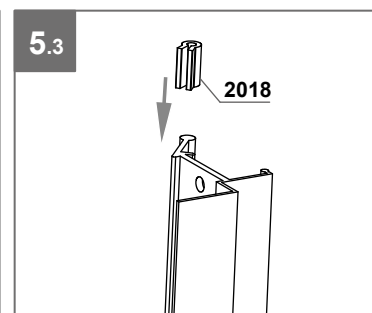
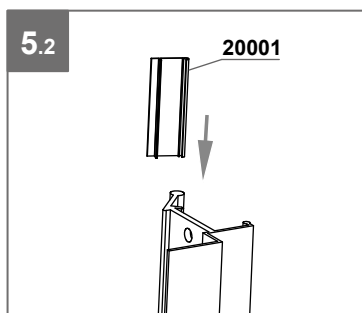
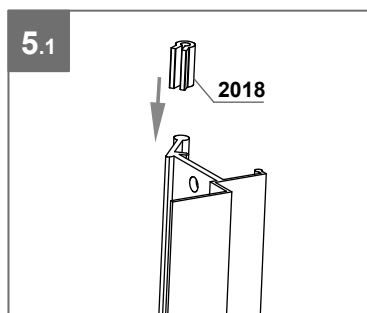
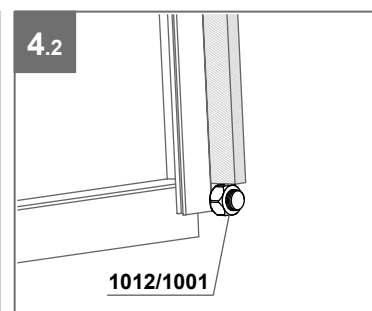
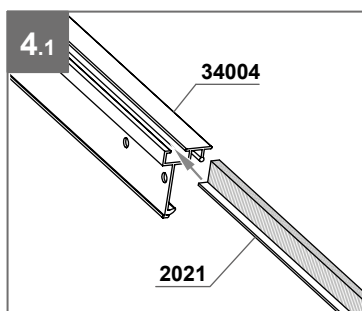
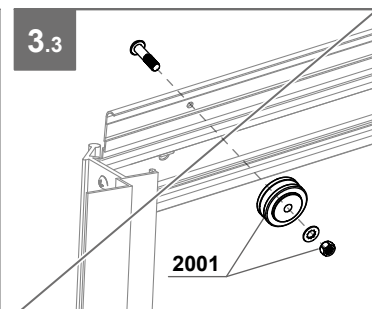
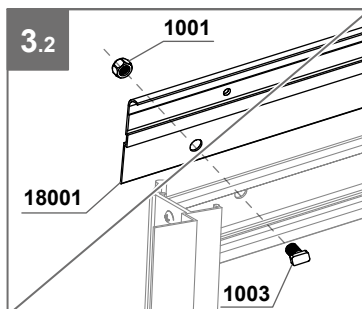
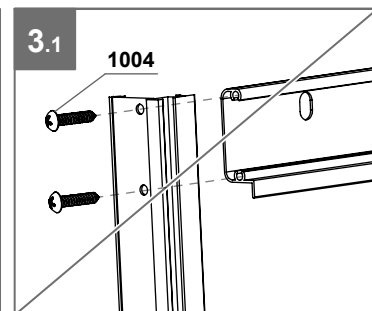
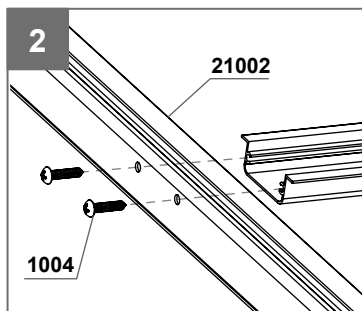
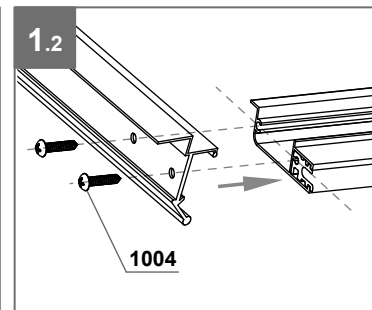
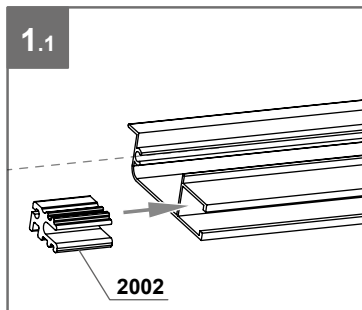
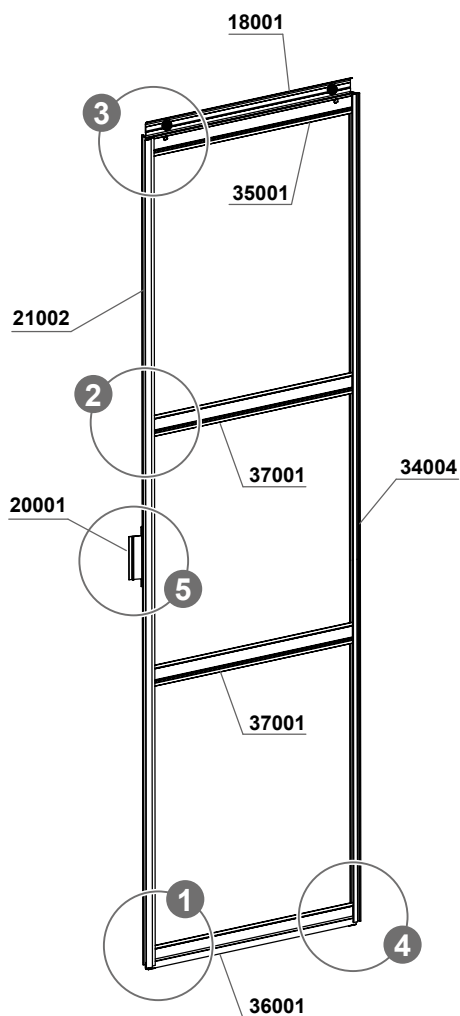

Module de base Basismodul Basic module

37001 x 2	2001 x 2	2002 x 2	2018 x 2	2021 x 1	1001 x 3	1003 x 2	1004 x 16	1012 x 1
18001 x 1	20001 x 1	21002 x 1	34004 x 1	35001 x 1	36001 x 1			

PORTE DROITE - RECHTE TÜR RIGHT DOOR

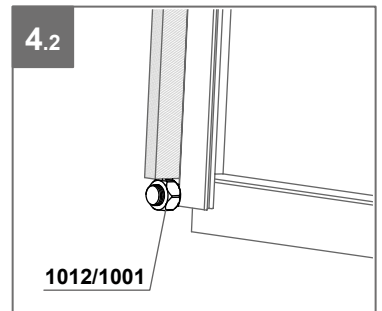
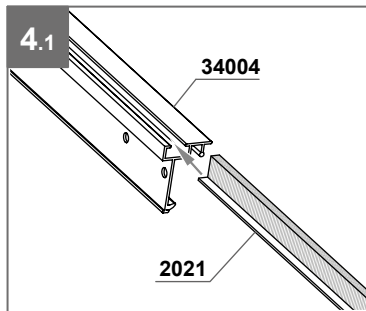
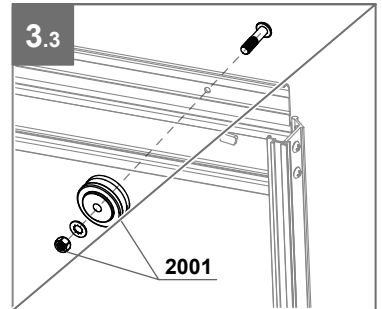
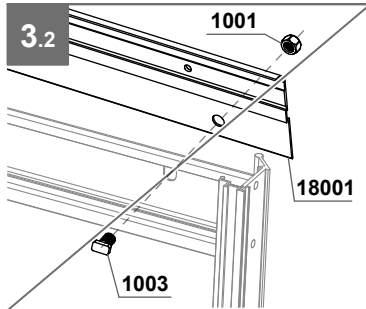
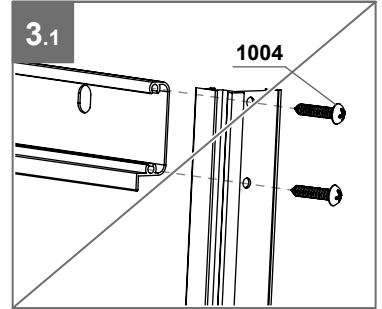
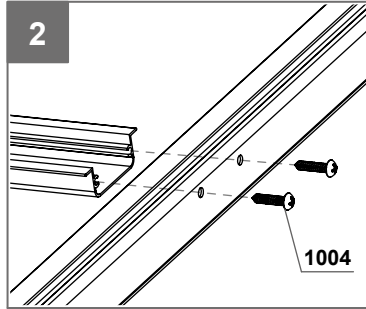
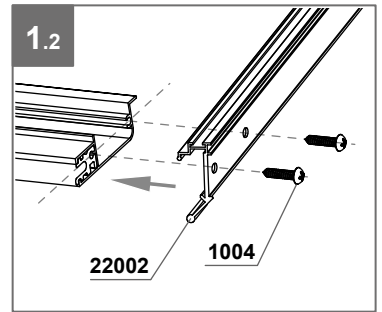
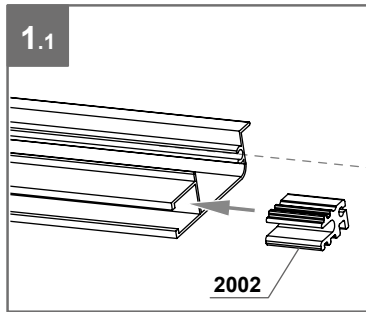
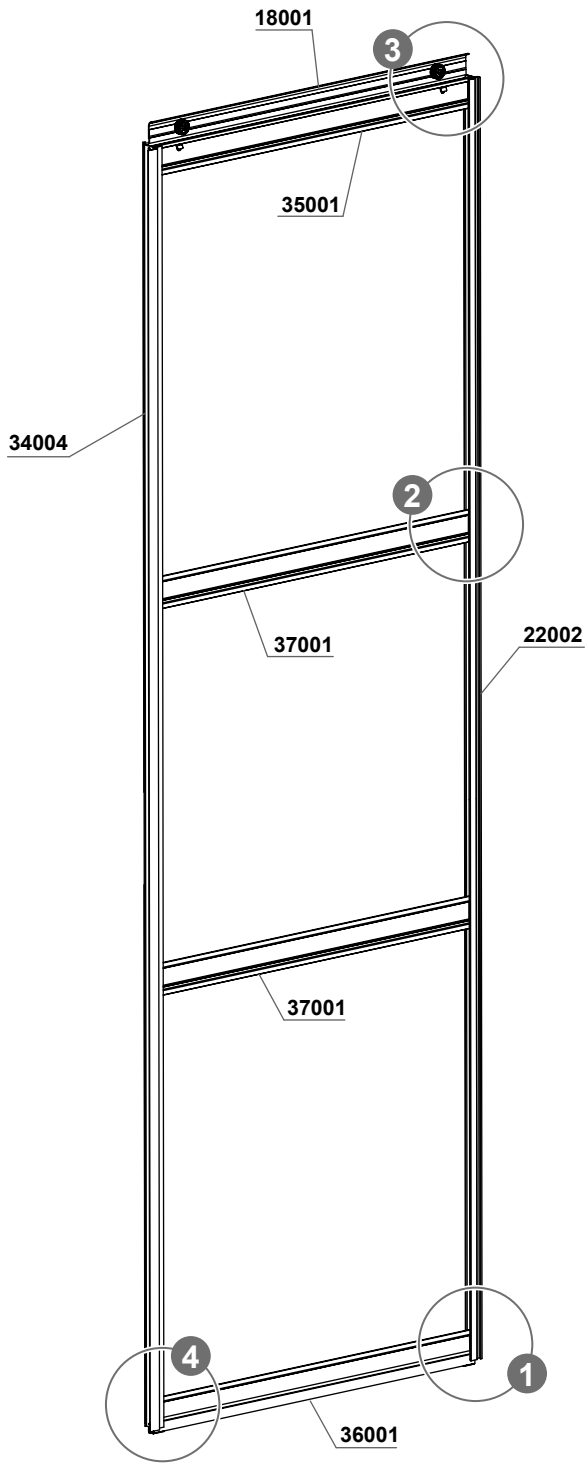







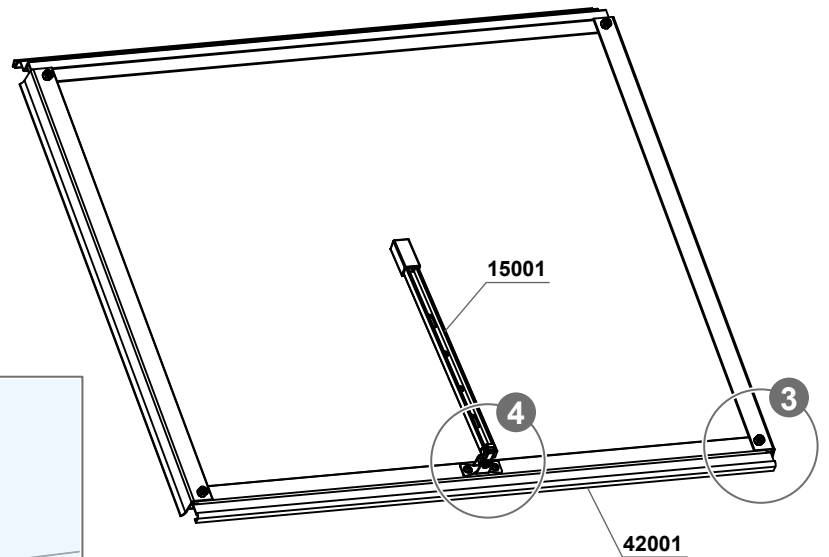
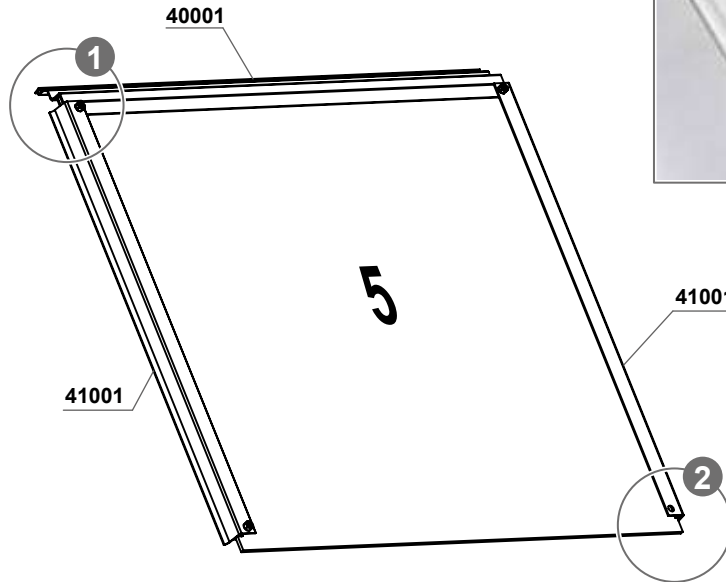
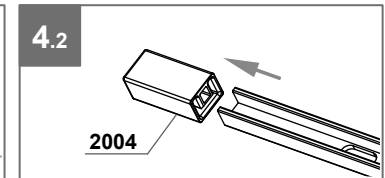
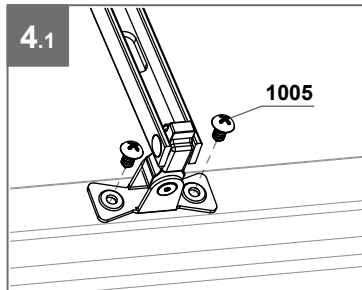
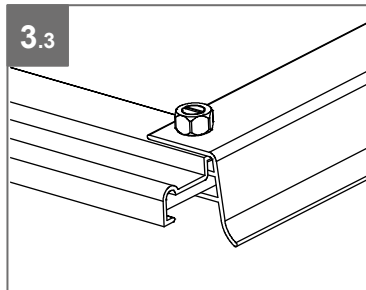
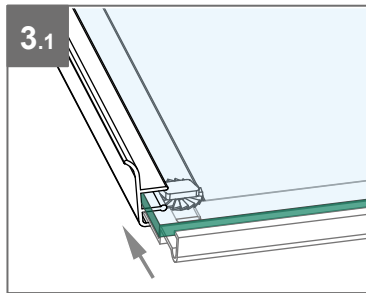
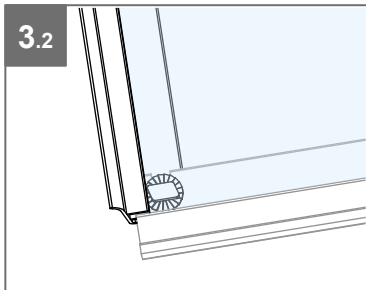
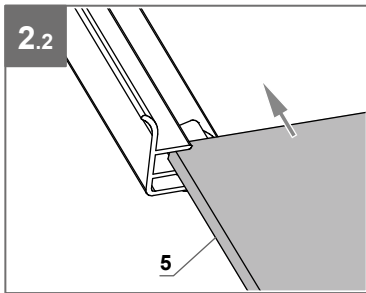
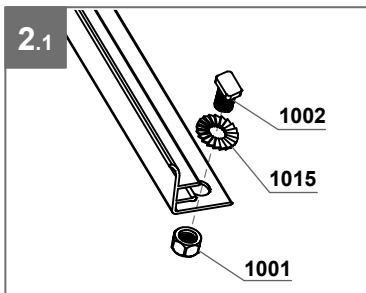
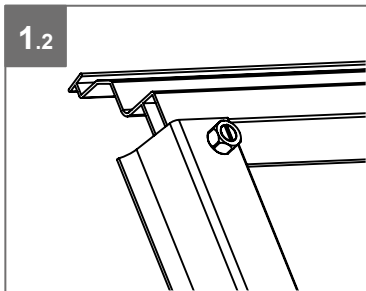
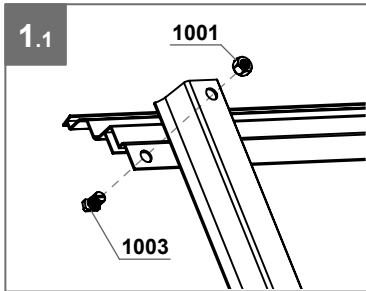

Module de base Basismodul Basic module

36001 x 1	37001 x 2	2001 x 2	2002 x 2	2021 x 1	18001 x 1	22002 x 1	34004 x 1	35001 x 1
1001 x 3	1003 x 2	1004 x 16	1012 x 1					

LUCARNE x2 - FENSTER x2 - WINDOW x2



Module de base - Basismodul - Basic module

 40001 x 2	 41001 x 4	 42001 x 2	 2004 x 2	 1001 x 8	 1002 x 4	 1003 x 4	 1005 x 4	 1015 x 4
---	--	--	---	---	--	---	---	---

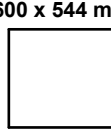
 15001 x 2	 600 x 544 mm 5 x 2
--	--

ASSEMBLAGE DES PAROIS - ZUSAMMENBAU DER WÄNDE

ASSEMBLY OF THE WALLS

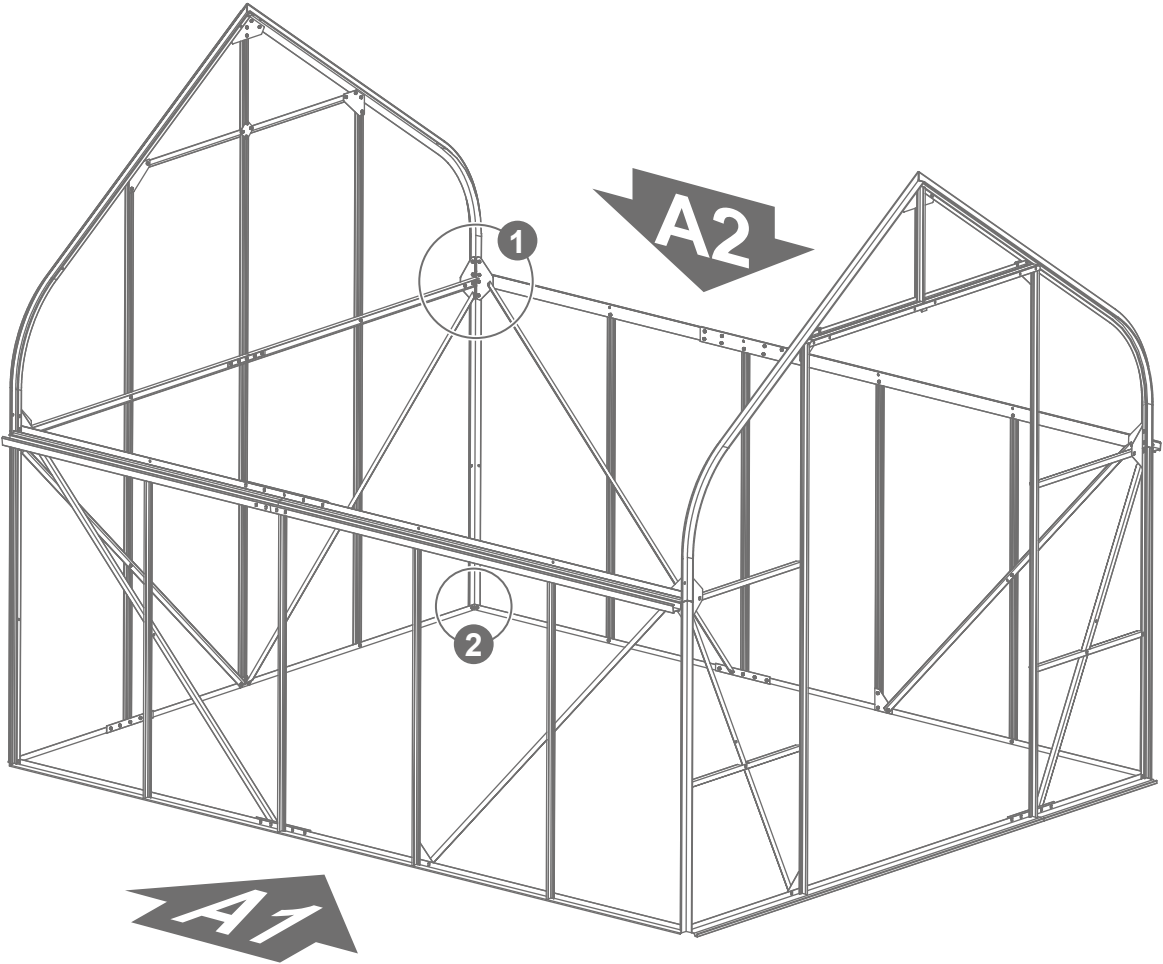

Module de base
Basismodul
Basic module

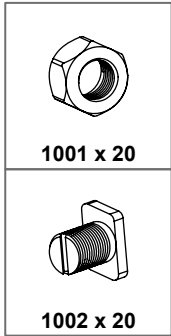
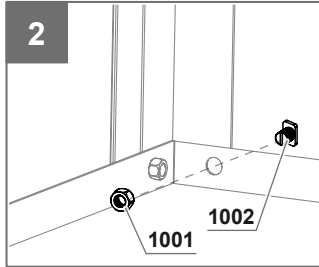
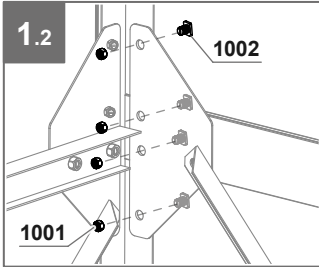
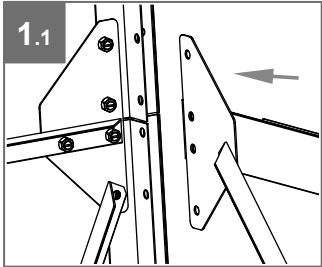
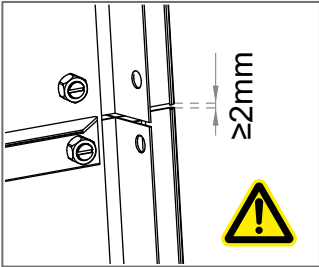

MONTAGE DES PROFILÉS DE TOITURE - MONTAGE DER DACHPROFILE ASSEMBLING THE ROOF PROFILES

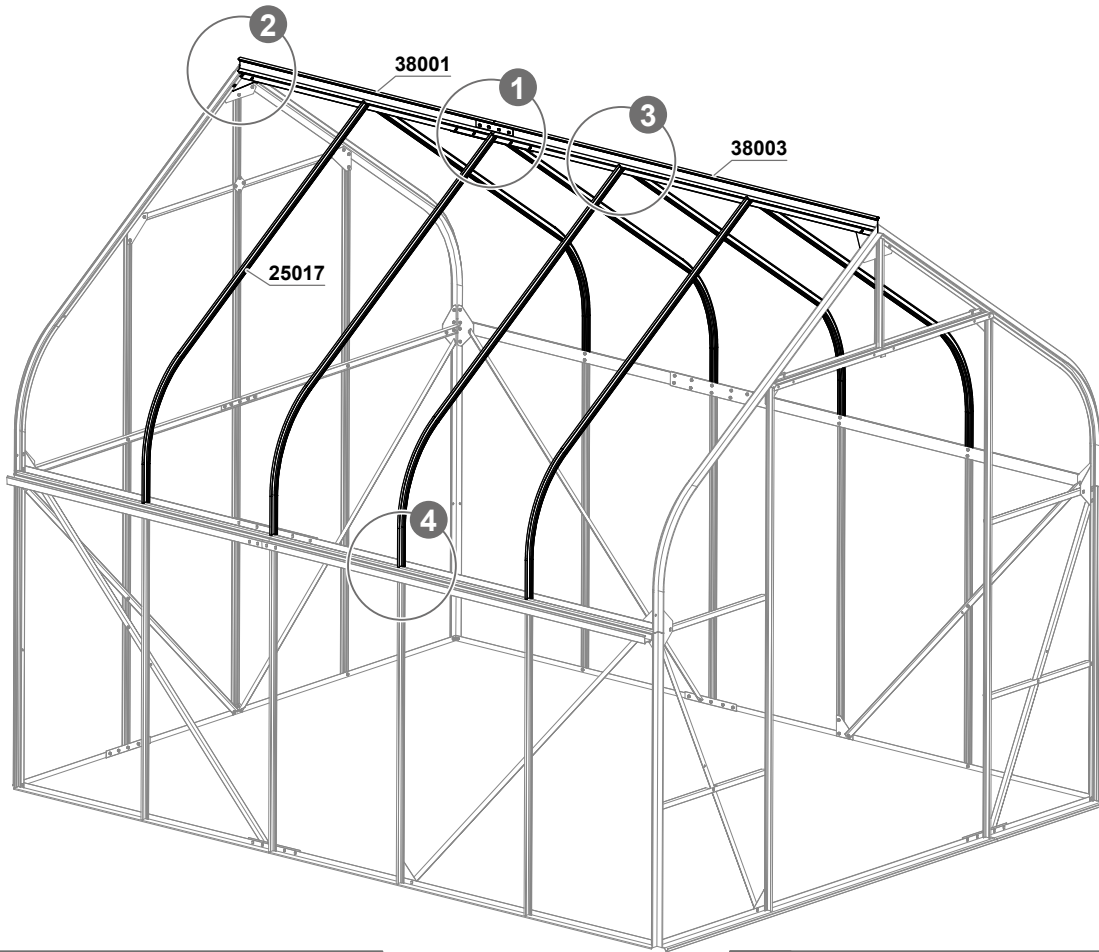

Module de base Basismodul Basic module

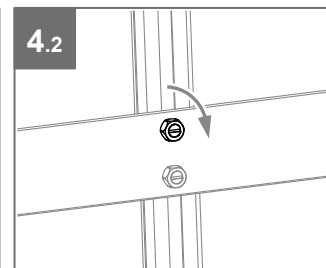
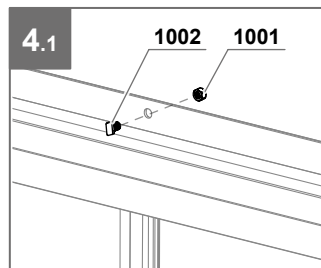
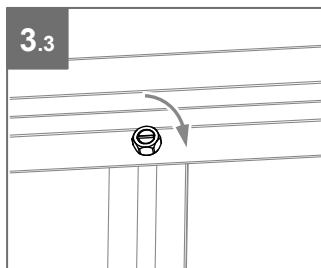
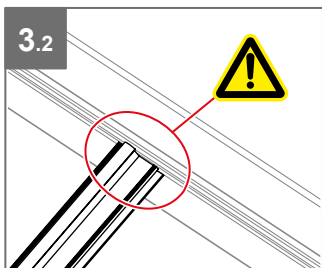
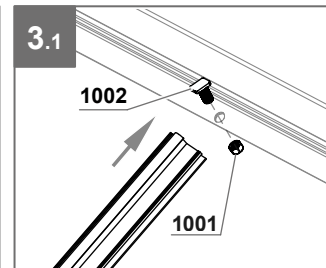
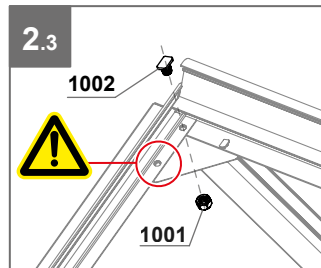
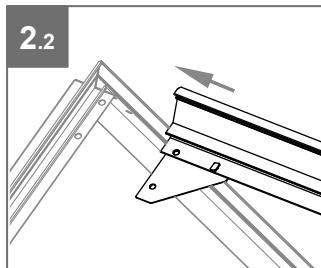
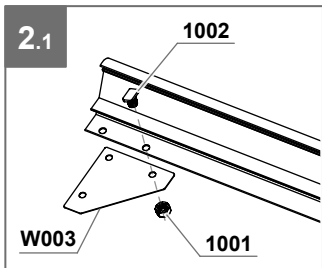
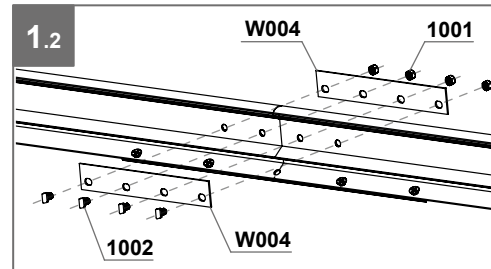
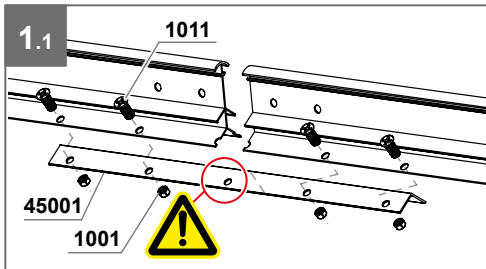
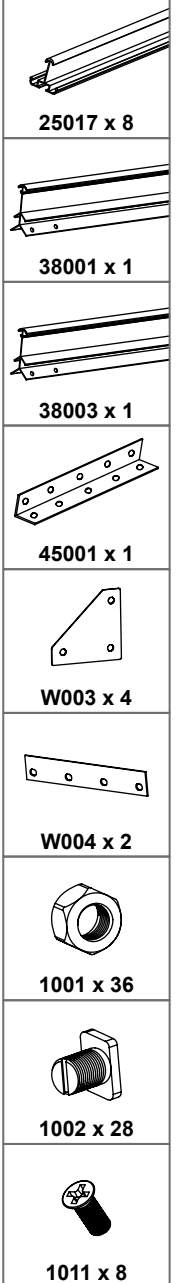

MONTAGE DES PROFILÉS DE TOITURE - MONTAGE DER DACHPROFILE ASSEMBLING THE ROOF PROFILES

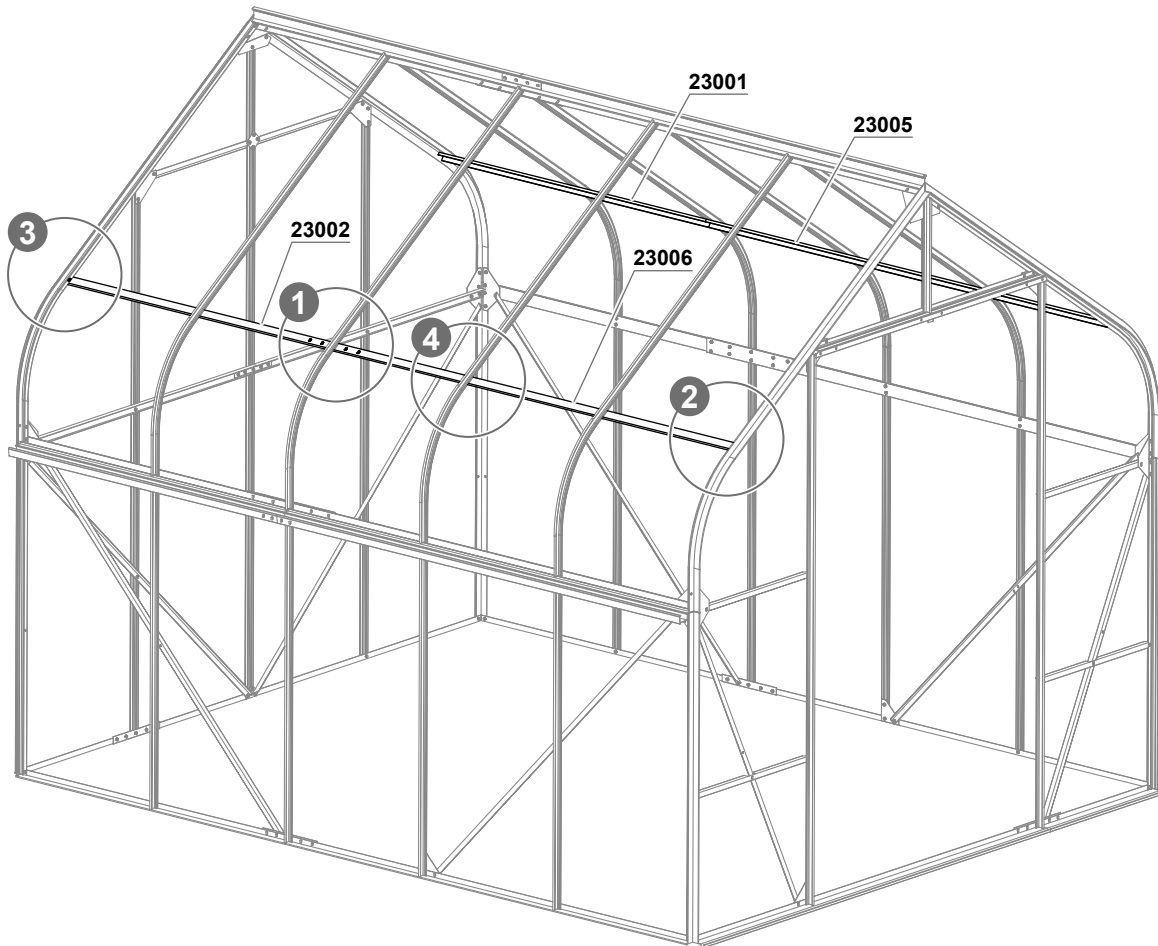

Module de base
Basismodul
Basic module

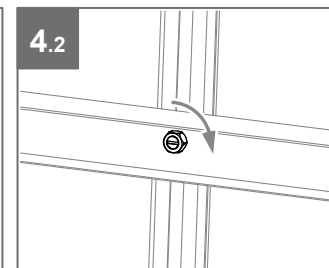
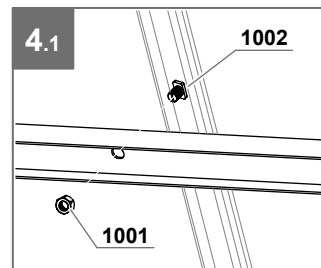
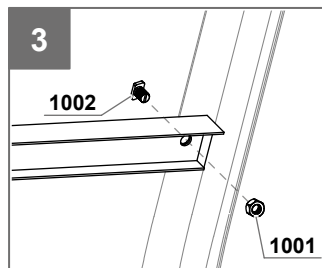
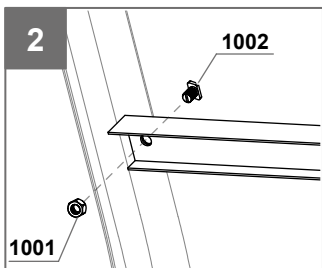
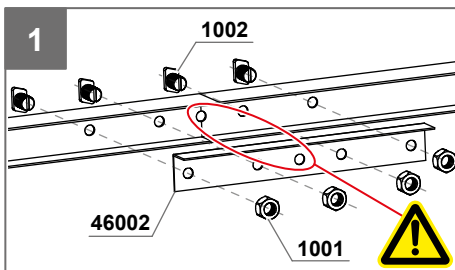
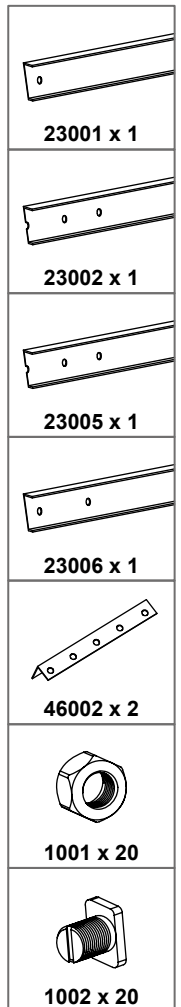

MONTAGE DES TENDEURS ET GOUSSETS SPANNVORRICHTUNG UND VERBINDER WIND BRACES AND GUSSETS

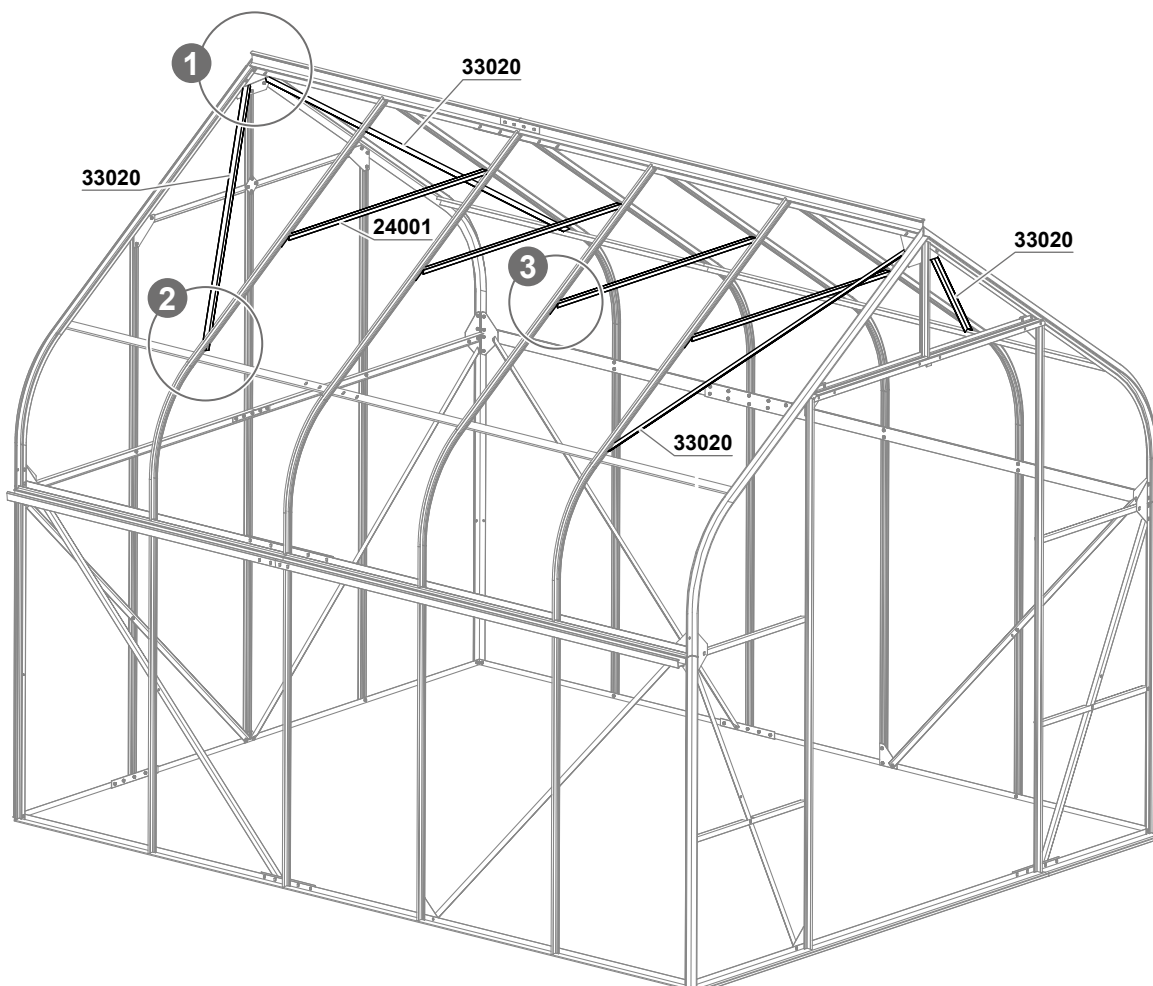

Module de base
Basismodul
Basic module

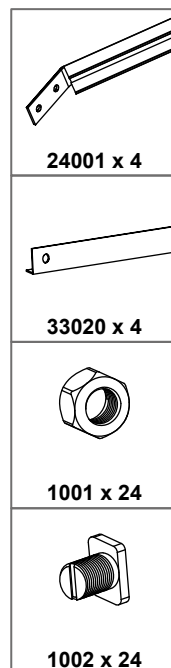
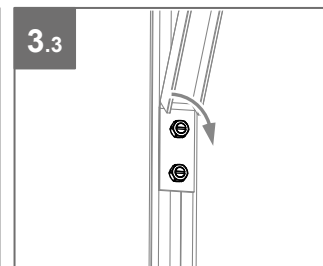
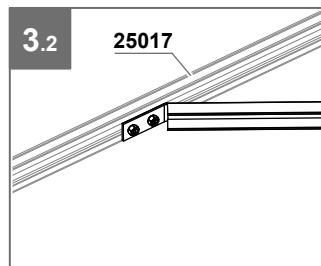
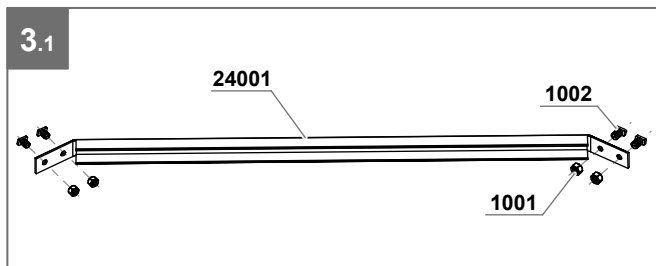
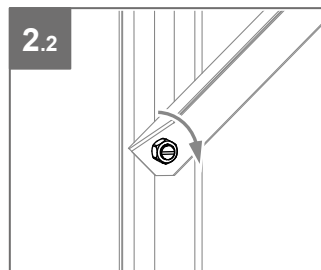
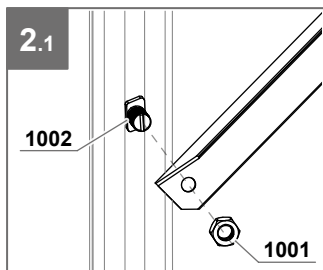
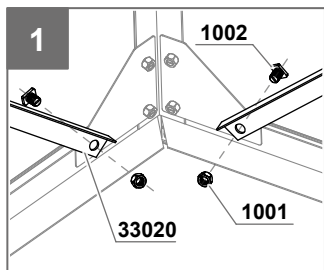

FIXATION DE LA SERRE SUR LA BASE BEFESTIGUNG DES GEWÄCHSHAUSES AM FUNDAMENTRAHMEN FASTENING THE GREENHOUSE ONTO THE GREENHOUSE BASE

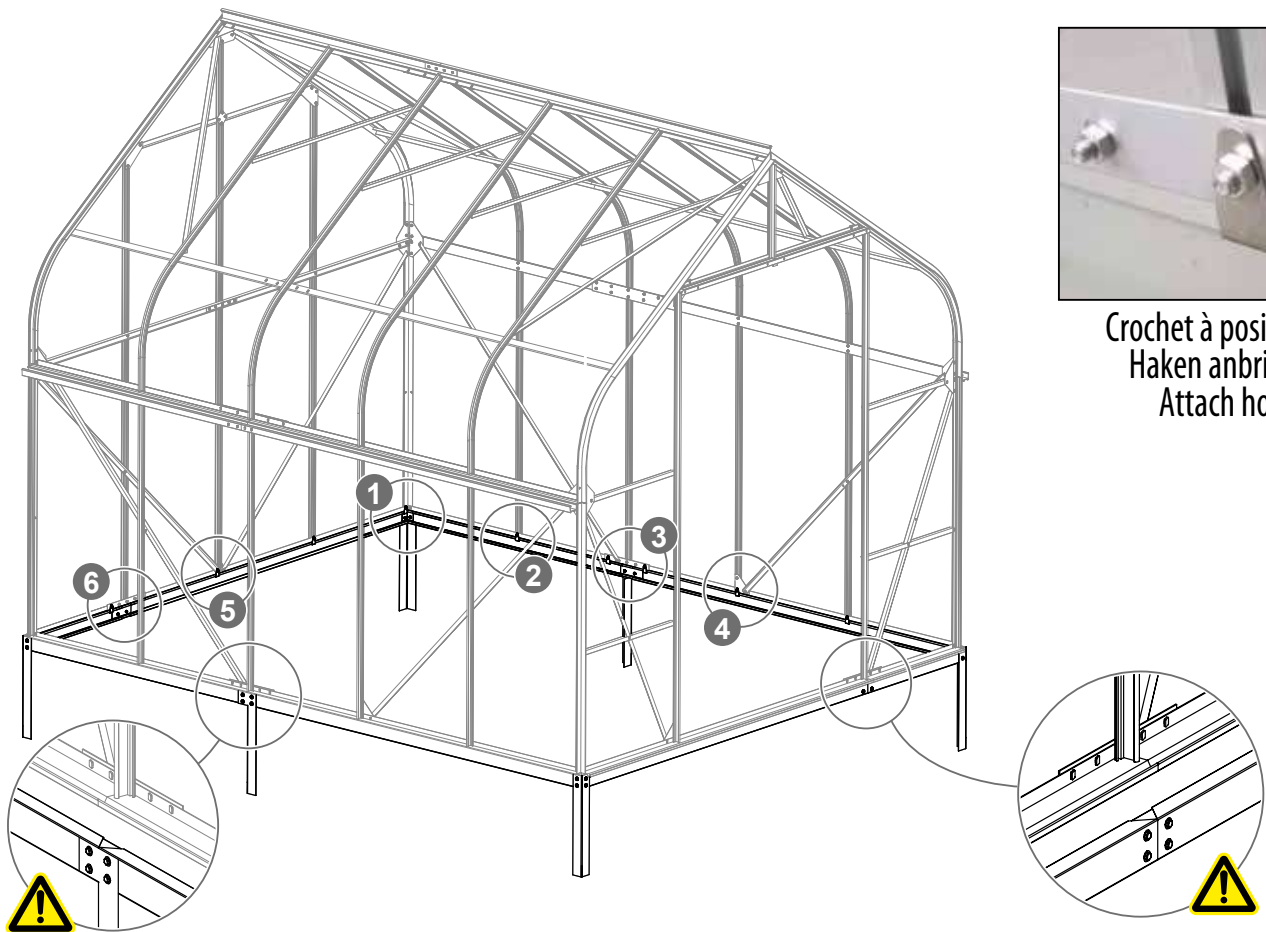

Crochet à positionner
Haken anbringen
Attach hook

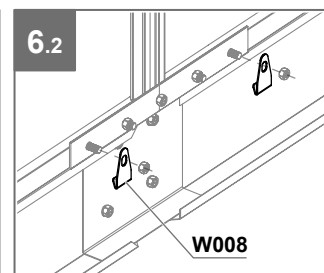
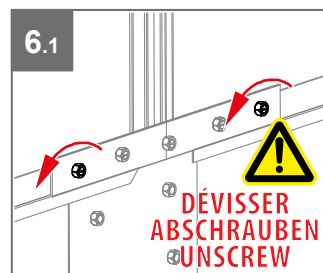
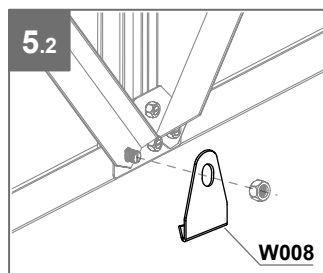
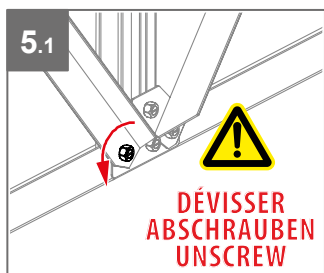
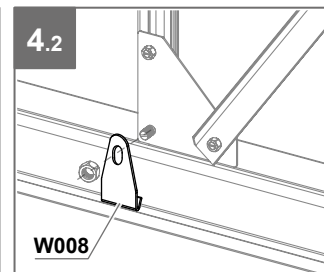
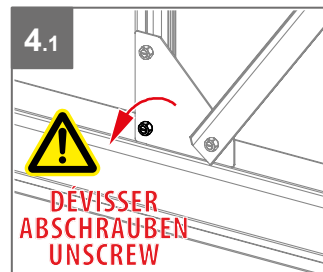
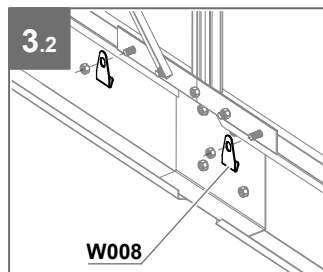
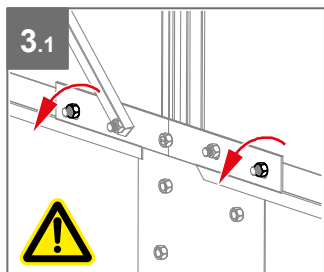
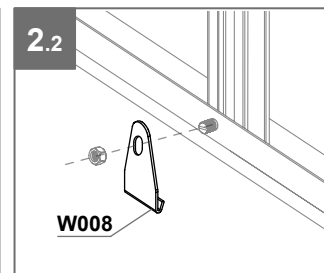
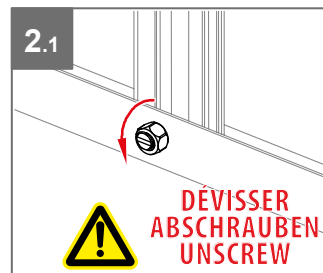
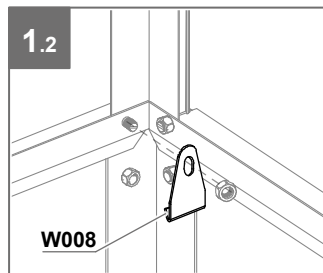
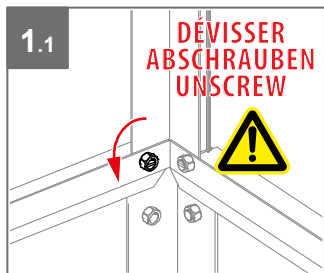

Module de base
Basismodul
Basic module

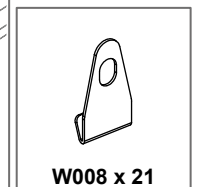

MONTAGE PORTE + RAIL MONTAGE TÜR + SCHIENE ASSEMBLING DOOR + RAIL

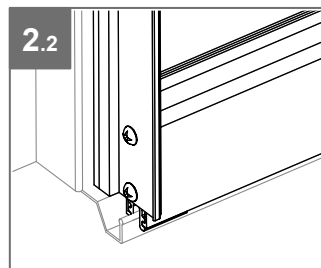
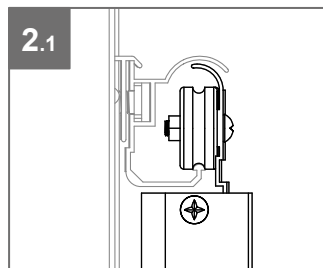
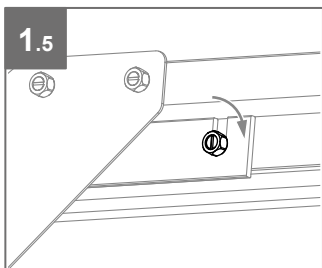
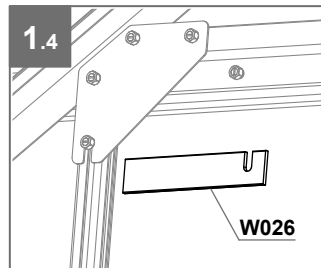
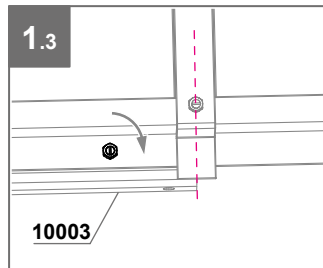
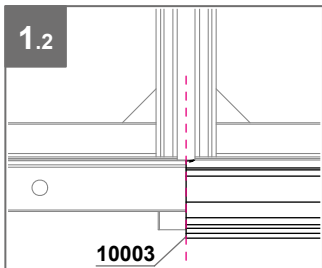
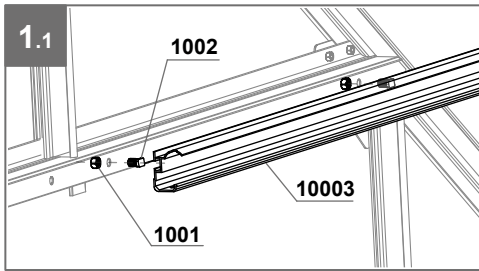
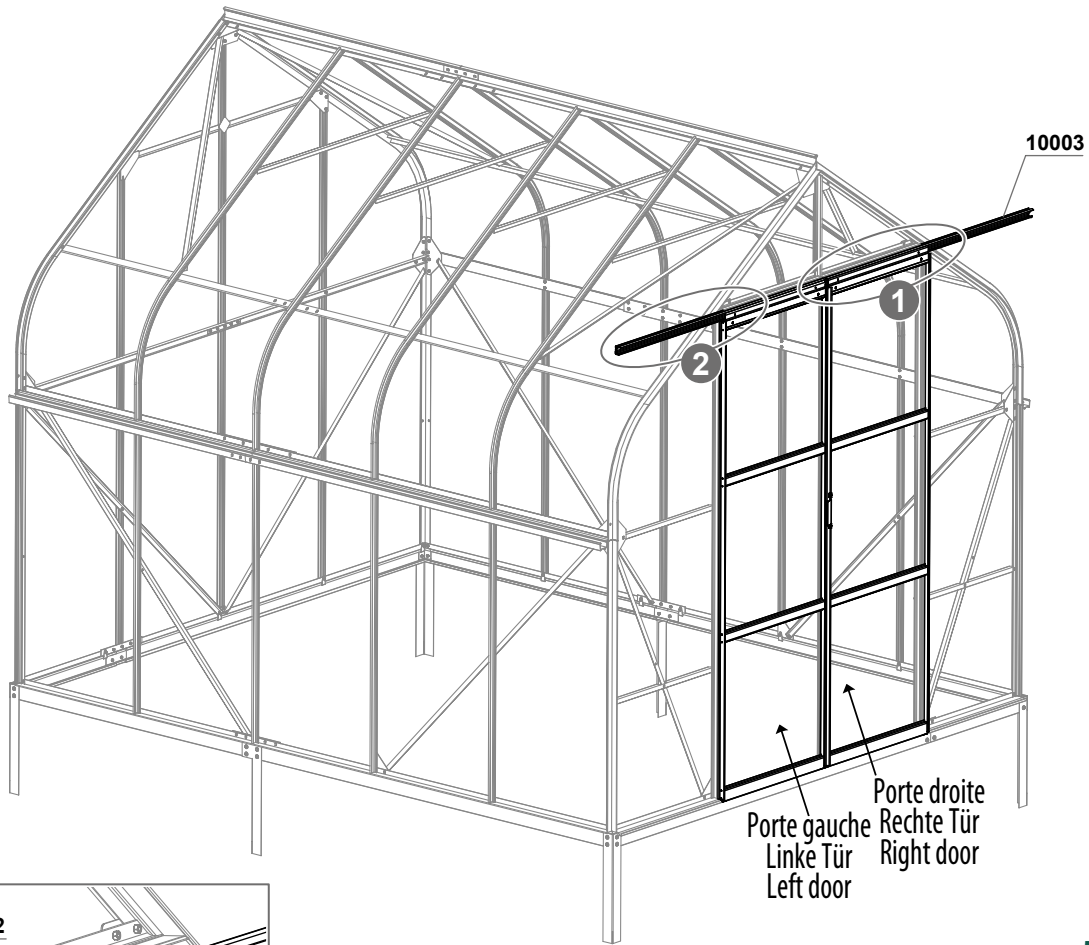

Recommandation : graissage régulier du rail.
Empfehlung : Schiene regelmäßig schmieren.
Recommendation : grease rail regularly.

Module de base Basismodul Basic module

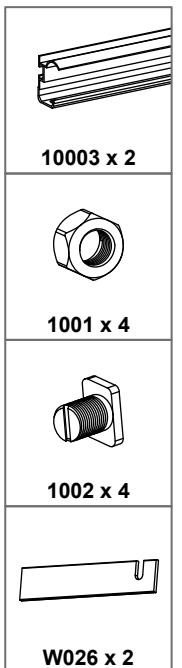

MONTAGE PORTE + RAIL MONTAGE TÜR + SCHIENE ASSEMBLING DOOR + RAIL

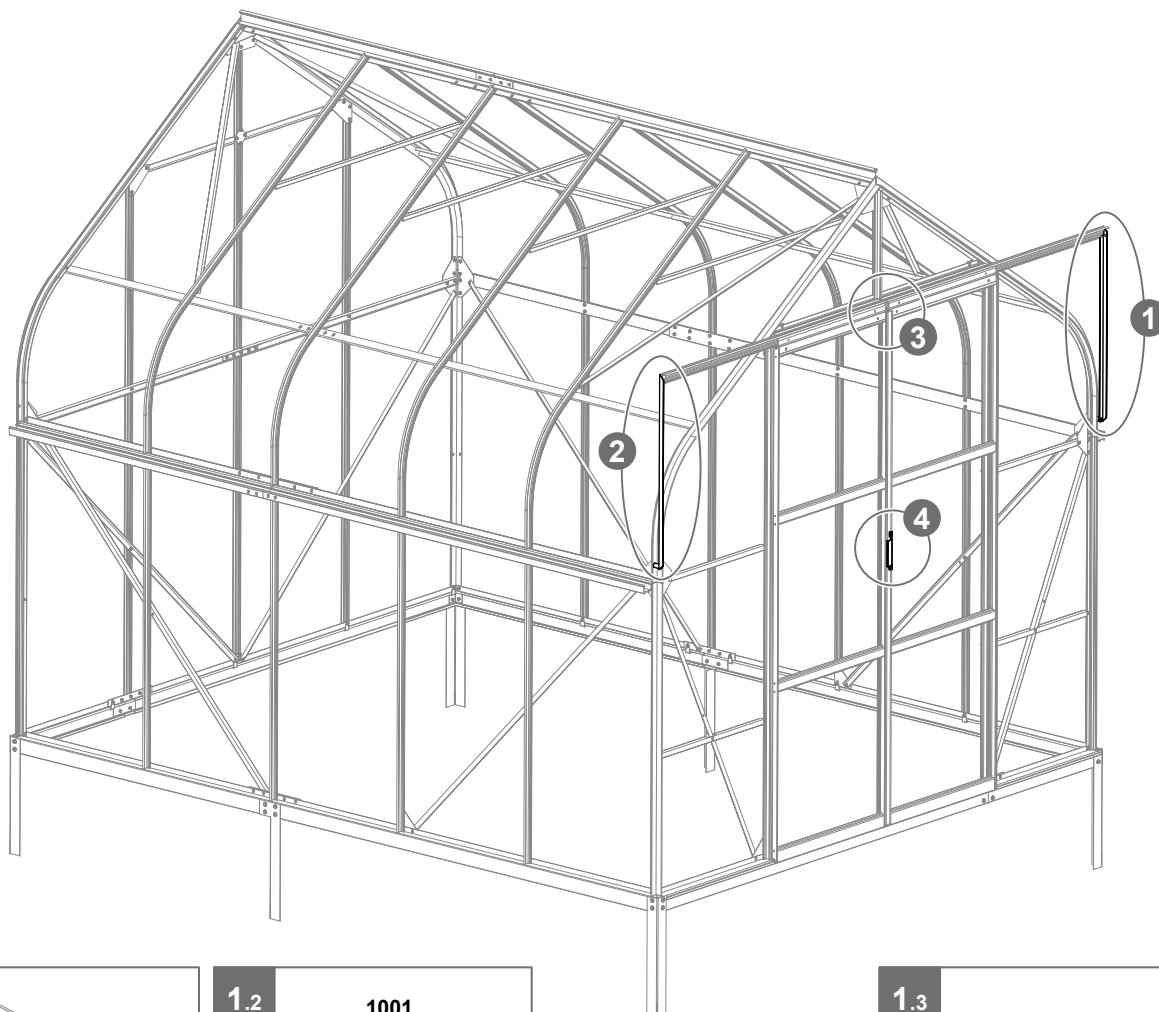

Module de base
Basismodul
Basic module

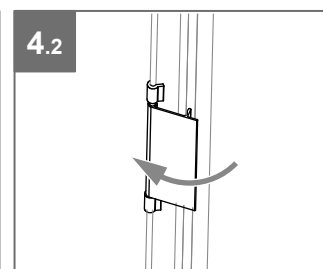
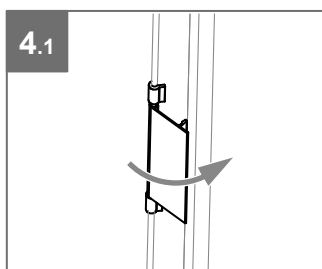
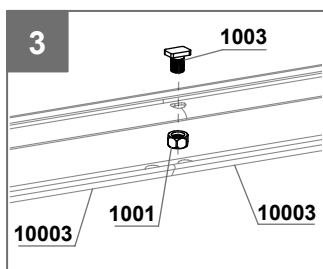
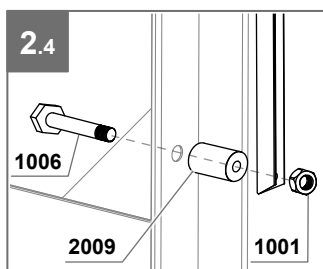
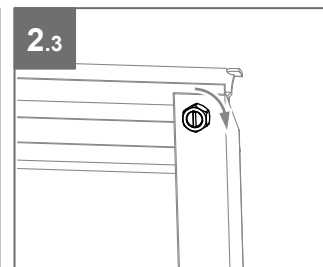
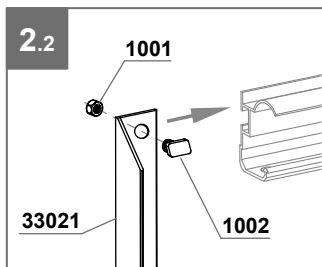
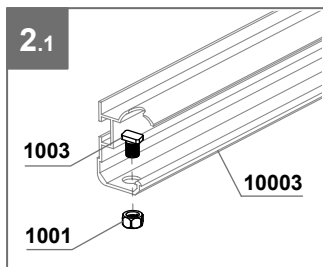
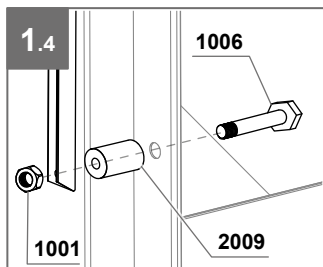
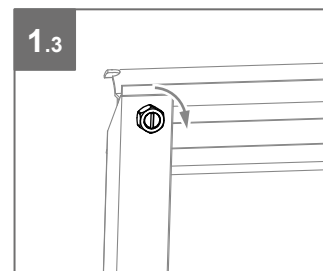
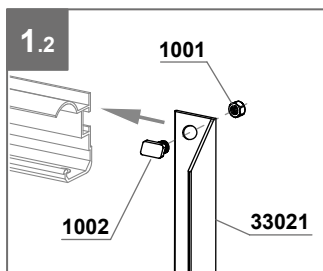
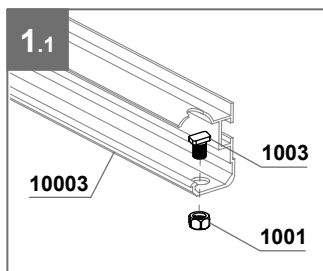

33021 x 2



1001 x 7



1002 x 2



1003 x 3



1006 x 2



2009 x 2

POSE DU JOINT DE VITRAGE VERGLASUNGSDICHTUNG ANBRINGEN INSTALLING THE GLAZING SEAL

Le joint caoutchouc est à poser sur les profilés de toiture, parois et porte.
Die Gummidichtung ist auf allen Dach-, Wand- und Türprofile anzubringen.
The rubber seal is to be attached on all the roof, wall and door profiles.

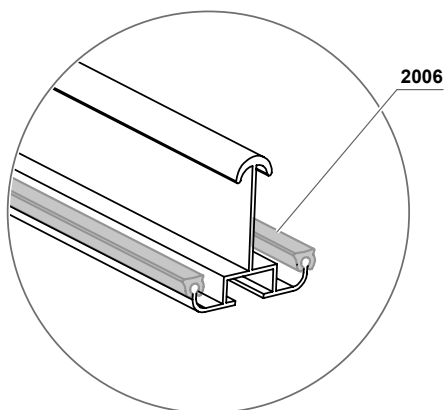

Module de base
Basismodul
Basic module

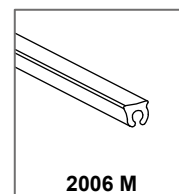

VITRAGE - VERGLASUNG - GLAZING

Nous vous conseillons d'installer les verres niveau par niveau (du bas vers le haut).

Wir empfehlen Ihnen, die Gläser Ebene für Ebene anzubringen (von unten nach oben).

We advise you to install the glazing level by level (from bottom to top).



Crochets de vitrage
Verglasungshaken
Glazing hooks



Clips de vitrage
Gewächshausklammern
Glazing clips

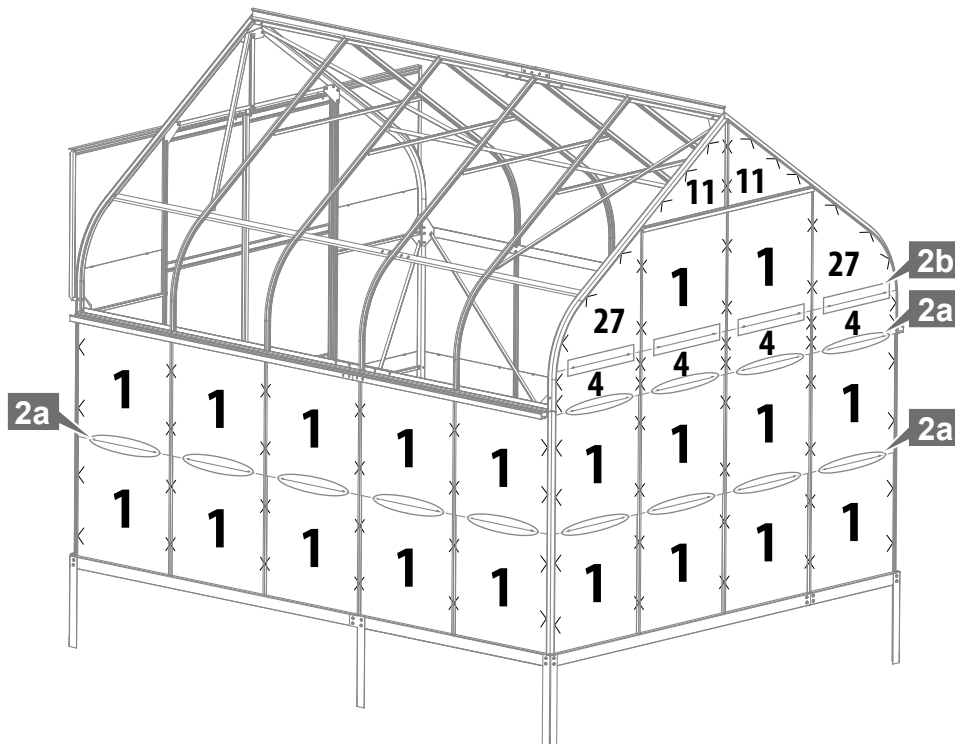
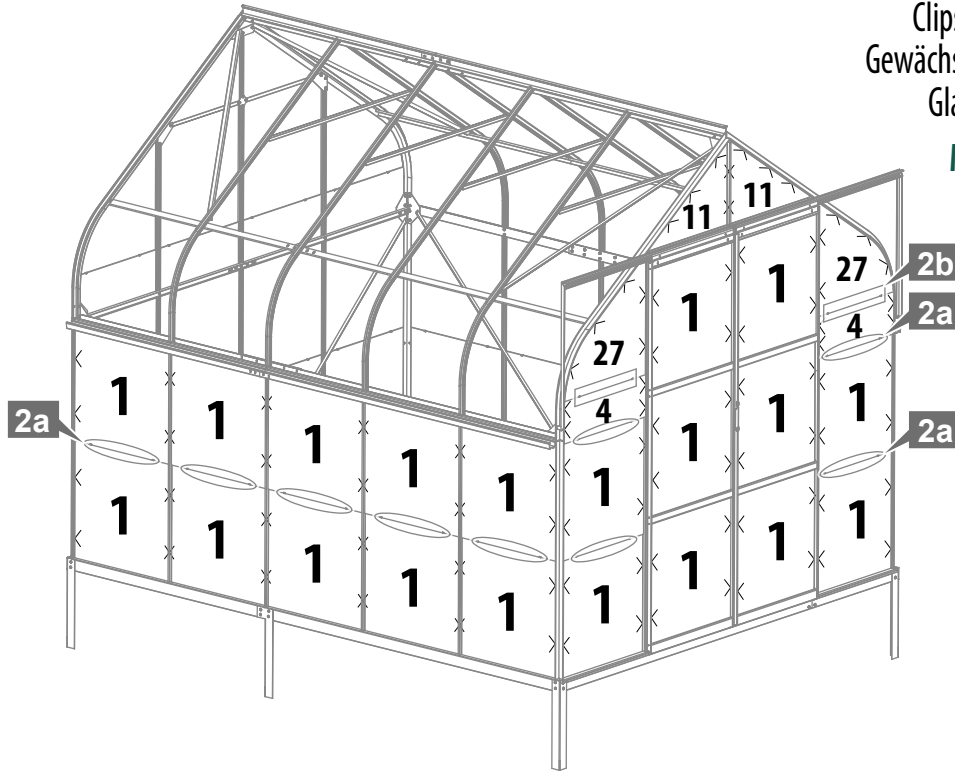
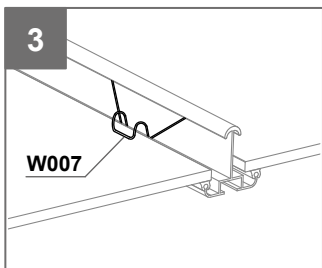
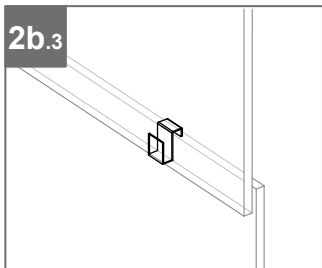
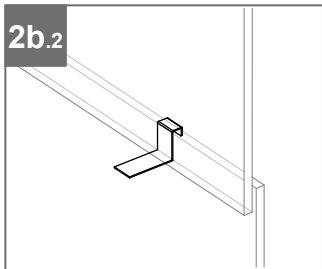
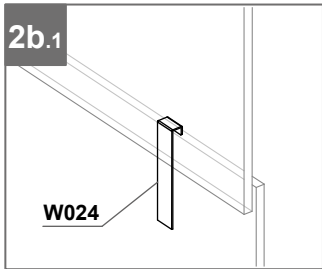
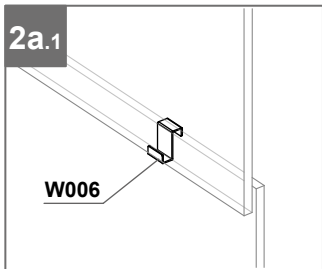
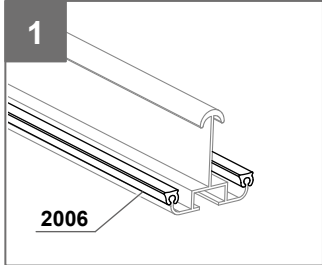

Module de base Basismodul Basic module

610 x 610	
1 x 40	
610 x 229	
4 x 6	
610 x 434/8	
11 x 4	
610 x 610	
27 x 4	
2006 x 100m	
W006 x 44	
W007 x 224	
W024 x 12	

VITRAGE + POSE LUCARNES

VERGLASUNG + FENSTERN EINBAUEN

GLAZING + INSTALLING WINDOWS



Lucarne - vue extérieure
 Fenster - Außenansicht
 Window - exterior view



1
 Pose de la lucarne sur faîtière
 par glissement.
 Anbringung des Fensters auf
 First durch Gleiten.
 Installing the window on
 roof ridge through sliding.

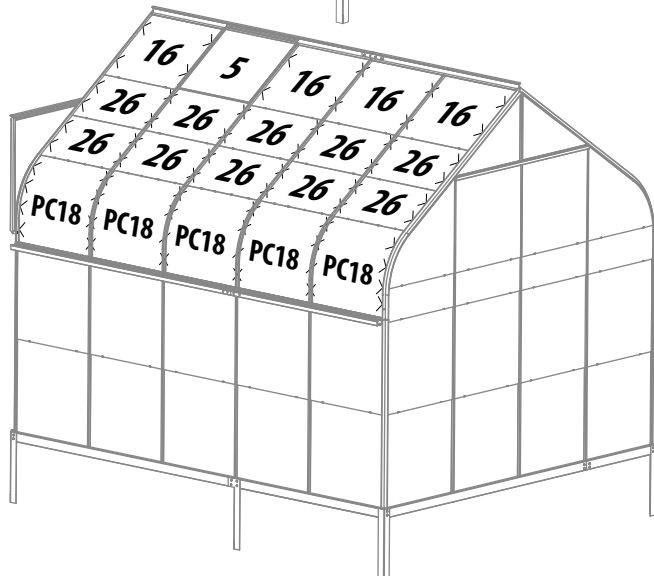
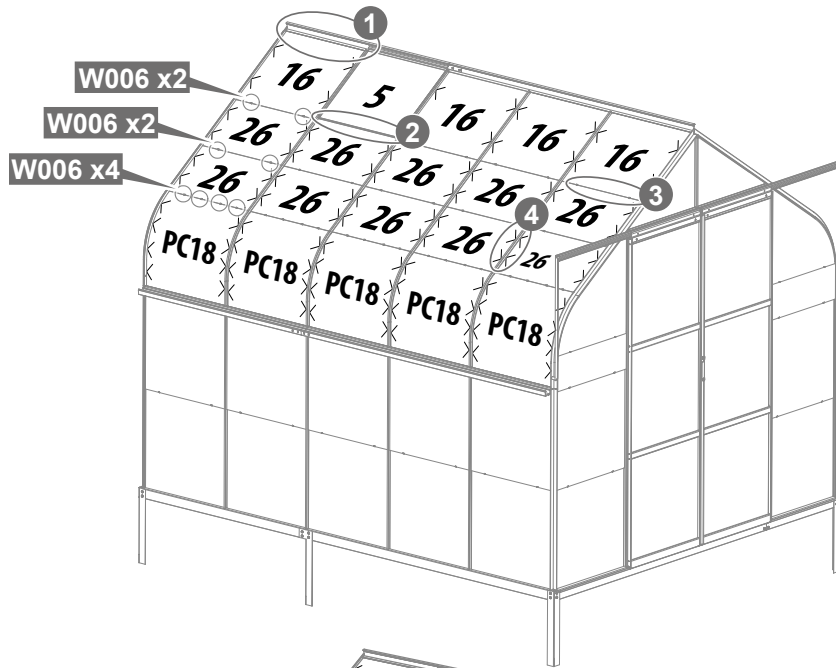

Module de base Basismodul Basic module

610 x 549	
16 x 8	
610 x 375	
26 x 20	
610 x 610	
PC18 x 10	
	39001 x 2
	1001 x 4
	1002 x 4
	1005 x 8
	2005 x 4
	W006 x 76
	W007 x 192

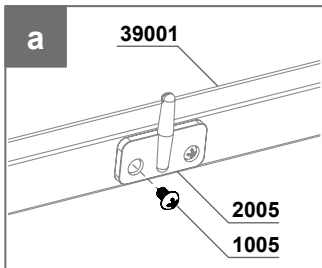
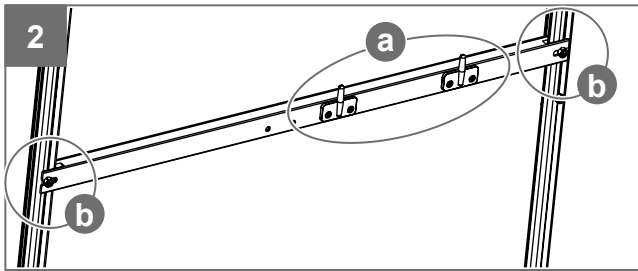

Dichtung schneiden um Einzelteil 39001 durchzulassen.
 Cut the seal to let part 39001 through.

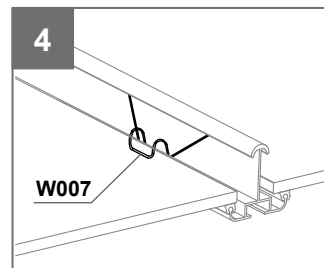
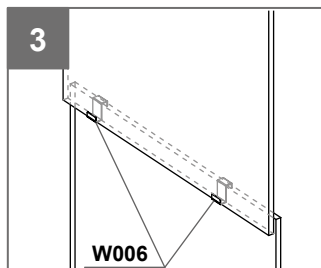
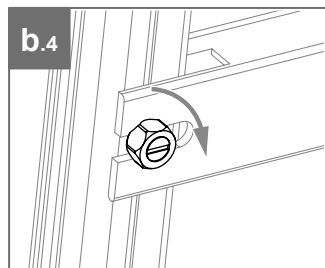
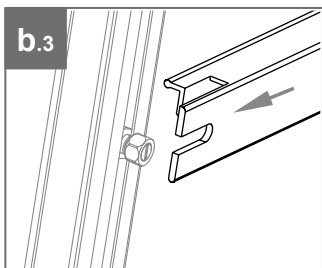
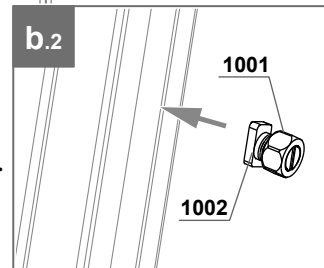

SERRE - GEWÄCHSHAUS - GREENHOUSE

ALOÉ 11,30 M²

Module de base 8,10 m² + module d'extension 3,20 m²











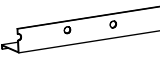

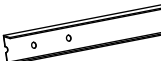



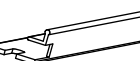

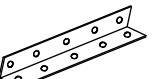
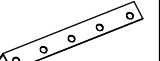
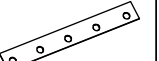
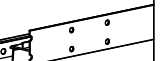
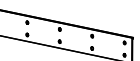
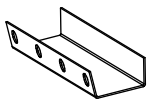
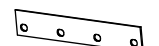
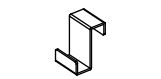

Basismodul 8,10 m² + Erweiterungsmodul 3,20 m²

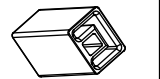
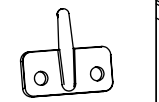
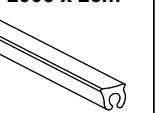
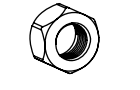
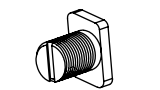
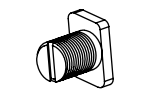
Basic modul 8,10 m² + extension module 3,20 m²

NOMENCLATURE EXTENSION - STÜCKLISTE ERWEITERUNG BILL OF MATERIALS EXTENSION

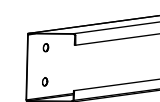
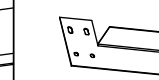
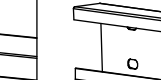

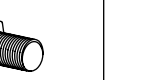

Colis - Paket - Parcel





1/2

PROFILÉS ALUMINIUM - ALUMINIUMPROFILE - ALUMINIUM PROFILES							
01006 x 2  L:1244 mm	15001 x 2  L:270 mm	23008 x 2  L:1244 mm	24001 x 2  L:1160 mm	25002 x 4  L:1214 mm	25017 x 4  L:1862 mm	38002 x 1  L:1244 mm	39001 x 2  L:634 mm
40001 x 2  L:602 mm	41001 x 4  L:518 mm	42001 x 2  L:602 mm	45001 x 1  L:400 mm	46001 x 2  L:250 mm	46002 x 2  L:200 mm	56006 x 2  L:1244 mm	57001 x 2  L:400 mm
PETITS COMPOSANTS - KLEINTEILE - SMALL COMPONENTS							
W002 x 2  M6 x 12 mm	W004 x 2  M6 x 8 mm	W006 x 36  M3.5 x 6 mm	W007 x 104  M6 x 14 mm	2004 x 2  Ø 6	2005 x 4  Ø 6	2006 x 25m  Ø 6	1001 x 92  M6
1002 x 80  M6 x 12 mm	1003 x 4  M6 x 8 mm	1005 x 12  M3.5 x 6 mm	1011 x 8  M6 x 14 mm	1015 x 4  Ø 6			
BASE ET VISSERIE - FUNDAMENTRAHMEN UND SCHRAUBEN - GREENHOUSE BASE AND SCREWS							
D010 x 2  1245x60x30 mm	D012 x 2  1245x60x30 mm	D014 x 2  1245x60x30 mm	1008 x 8  Ø 6	1009 x 8  Ø 6	1010 x 8  Ø 6	W008 x 6  Ø 6	

Colis - Paket - Parcel

2/2

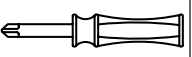
VERRES - GLÄSER - GLAZING							
1 x 8  610 x 610 mm	5 x 2  600 x 544 mm	16 x 2  610 x 549 mm	26 x 8  610 x 375 mm	PC18 x 4  610 x 610 mm			

OUTILS INCLUS VORHANDENE WERKZEUGE TOOLS INCLUDED		NON INCLUS NICHT VORHANDEN NOT INCLUDED	
 M6/10 mm	 M6/10 mm	 10 mm	 10 m

MONTAGE BASE - MONTAGE FUNDAMENTRAHMEN - BASE ASSEMBLING

Il est impératif que la base soit montée de niveau.



Es ist zwingend erforderlich, dass der Fundamentrahmen auf einer geraden Ebene montiert wird.

It is imperative that the greenhouse base is leveled.

Module de base Basismodul Basic module

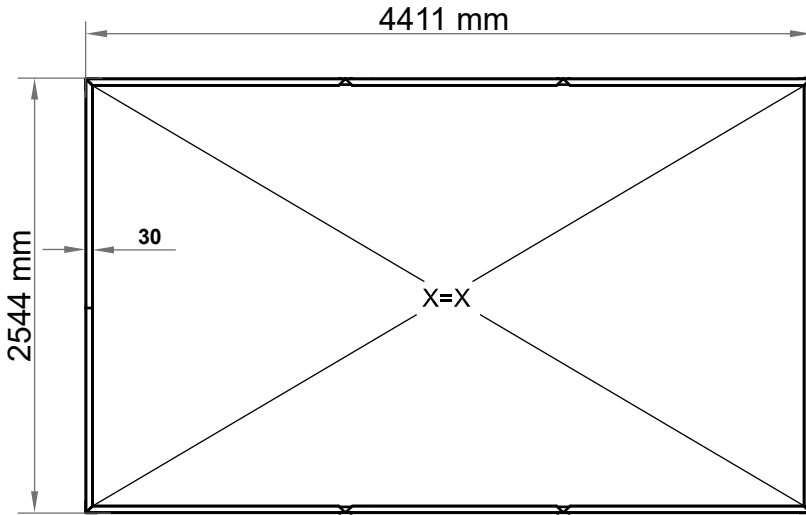

FACE AVANT (AVEC PORTE)
VORDERWAND (MIT TÜR)
FRONT WALL (WITH DOOR)

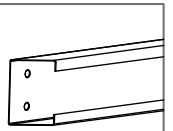
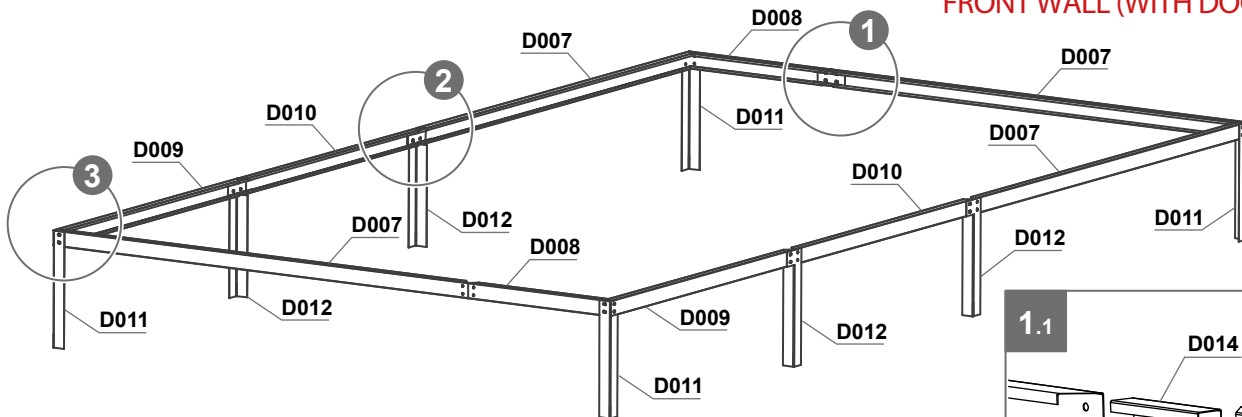

D007 x 4

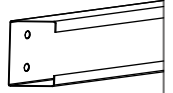

D008 x 2

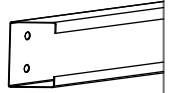

D009 x 2

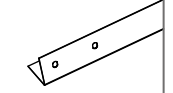

D011 x 4

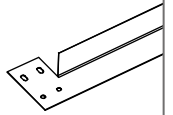

D012 x 2

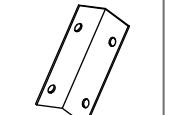

D013 x 4

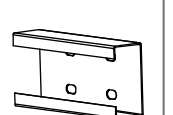

D014 x 4

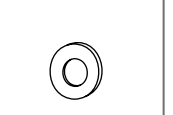

1008 x 32

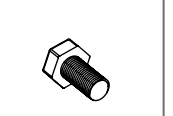

1009 x 32

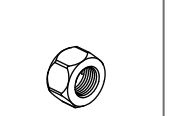

1010 x 32

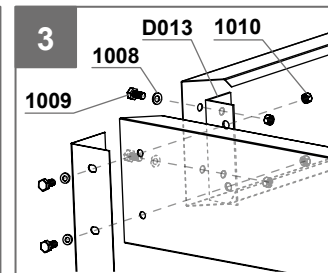
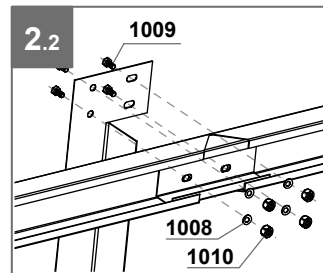
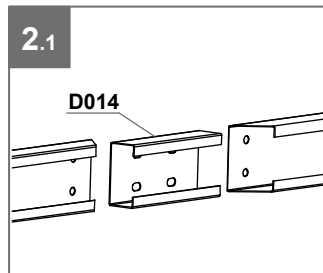
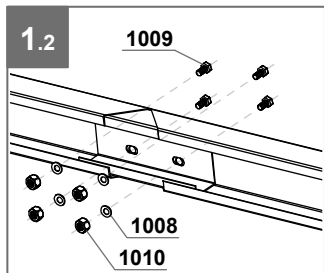
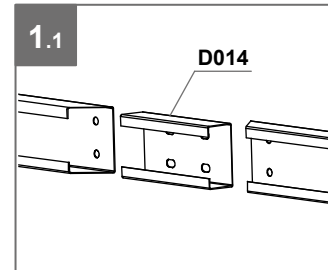

Module d'extension Erweiterungsmodul Extension module

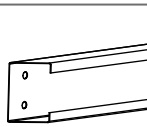

D010 x 2

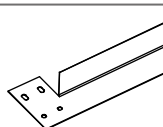

D012 x 2

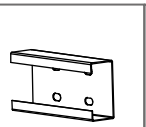

D014 x 2

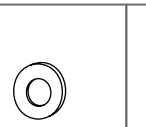

1008 x 8

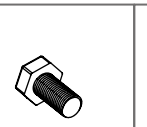

1009 x 8

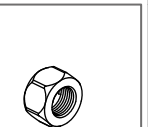

1010 x 8

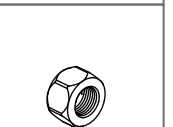

1010 x 32



FIXATION DE LA BASE AU SOL

FIXATION EN PLEINE TERRE

- Positionner la base à l'endroit voulu, de niveau sur un sol damé.
- Repérer et marquer l'emplacement des pattes de scellement suivant le schéma ci-dessous.
- Sous les quatre pieds marquer un carré de 300 x 300 mm et creuser sur une profondeur de 450 mm
- Placer la base, la mettre de niveau mais ATTENTION, ne pas remplir les trous avant le montage complet de la serre.

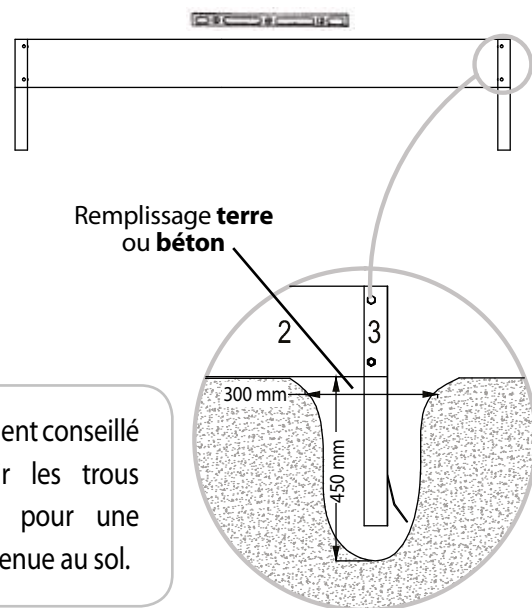
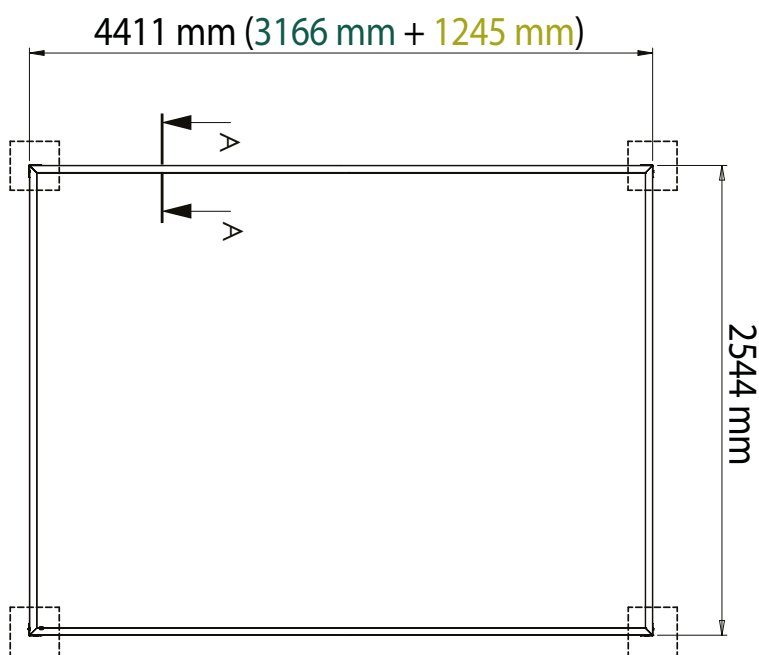

Il est vivement conseillé de remplir les trous de béton pour une meilleure tenue au sol.

OU

FIXATION SUR DALLE BÉTON

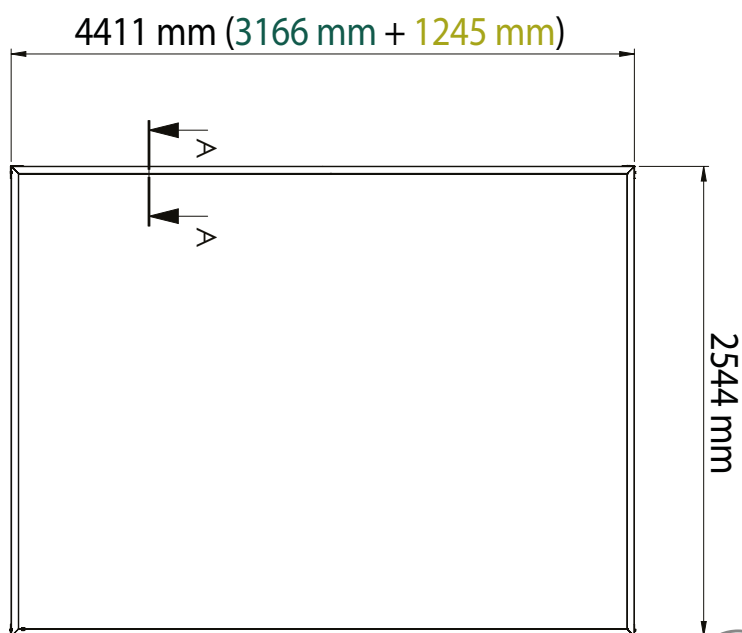

Détail A-A

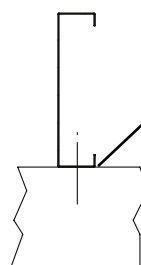

Fixation par chevilles à l'intérieur de la base



Visseries et chevilles de fixation non fournies

Il est laissé à votre libre choix et décision, l'utilisation des fixations adéquats selon les supports que vous décidez d'utiliser (pourtour bois, parpaings, plaques ciment, ...).



BEFESTIGUNG DES FUNDAMENTRAHMENS AM BODEN

BEFESTIGUNG AUF ERDBODEN (Punktfundament)

- Stellen Sie den Fundamentrahmen an der gewünschten Stelle, ebenerdig, auf einem gefüllten Boden.
- Orten und markieren Sie die Stelle der Ankerbeine gemäß dem untenstehenden Schema.
- Unter den vier Beinen ein 300 x 300 mm Quadrat kennzeichnen und 450 mm tief graben.
- Den Fundamentrahmen platzieren und nivellieren, aber **ACHTUNG**, die Löcher erst füllen, wenn das Gewächshaus komplett montiert ist.

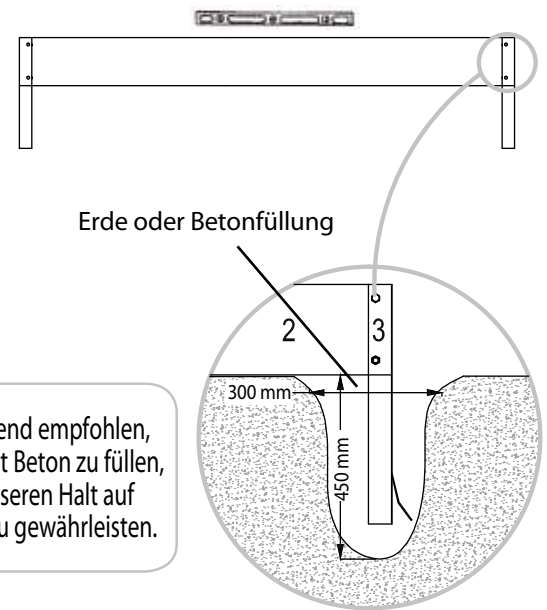
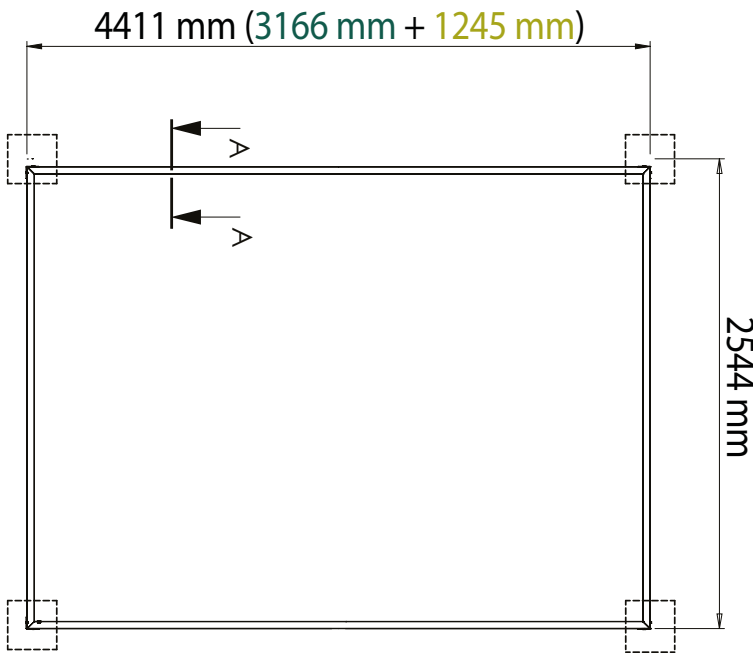

Es wird dringend empfohlen, die Löcher mit Beton zu füllen, um einen besseren Halt auf dem Boden zu gewährleisten.

ODER

BEFESTIGUNG AUF BETONDECKE (Streifenfundament)

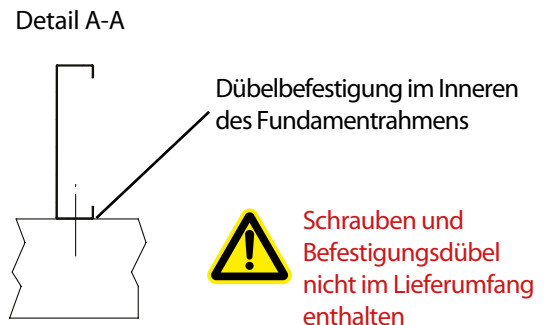
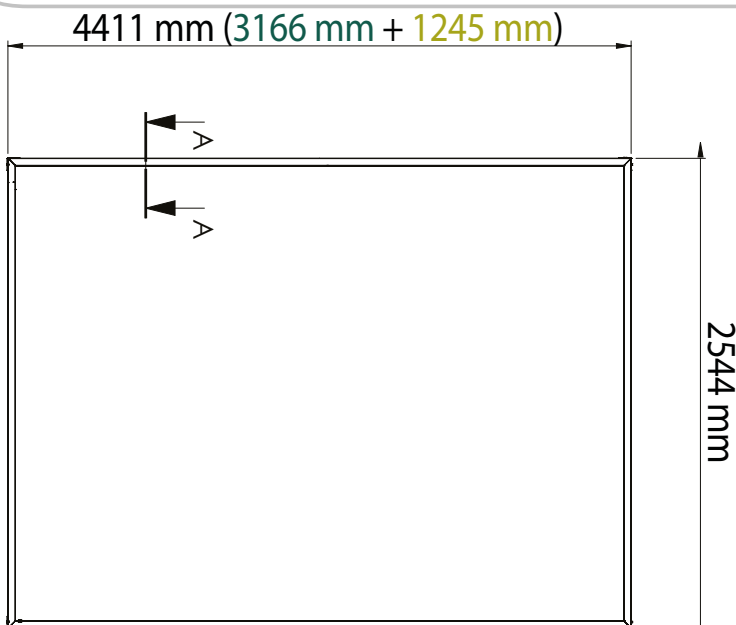

Es bleibt Ihrer freien Wahl und Entscheidung überlassen, die geeigneten Befestigungsmittel entsprechend der von Ihnen gewählten Träger (Holzumrandung, Bausteine, Zementplatten,...) zu verwenden.



FIXING THE GREENHOUSE BASE TO THE GROUND

FIXING ON SOIL

- Position the greenhouse base in the desired location at a level position on a filled floor.
- Locate and mark the location of the base legs as shown bellow.
- Under the four legs, mark a square of 300 x 300 mm and dig to a depth of 450 mm.
- Place the GREENHOUSE BASE, level it but CAUTION, do not fill the holes before the complete assembly of the greenhouse.

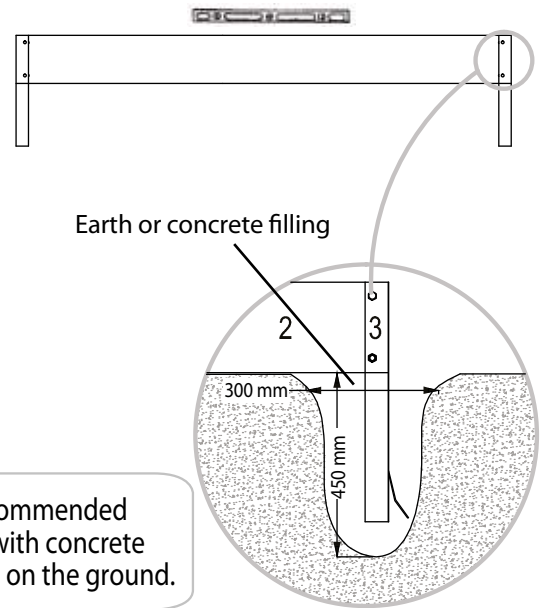
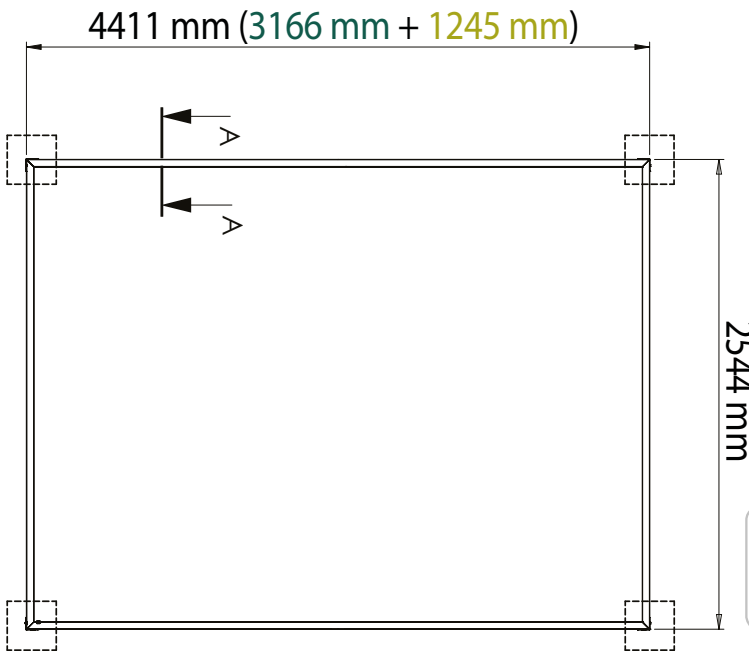

OR

FIXING ON CONCRETE SLAB

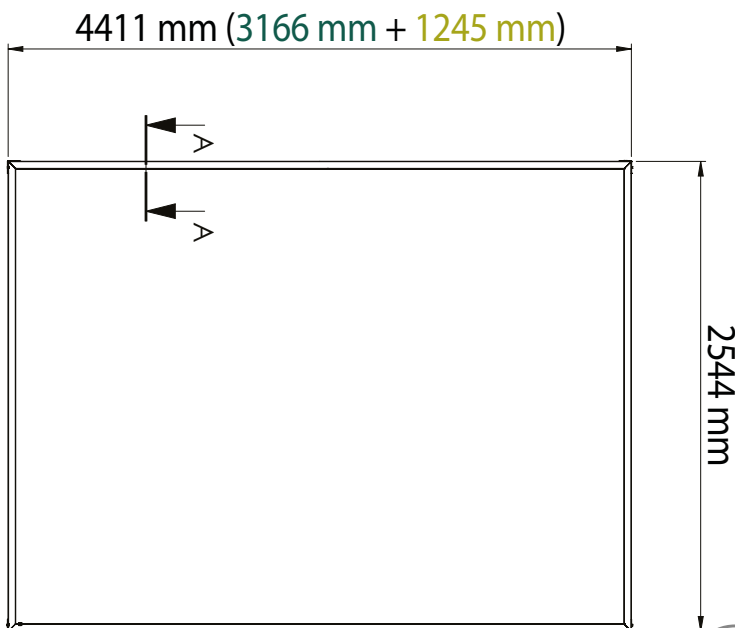

Detail A-A

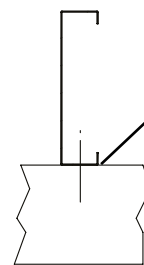

Rawplug fastening inside the greenhouse base



Screws and rawplugs not provided

It remains to your free choice and decision to use the suitable fastening means according to the supports you chose (wood border, building stones, cement plates etc.)

VIS 1002 & 1003 - SCHRAUBEN 1002 & 1003 - SCREWS 1002 & 1003

Mise en place des vis 1002 et 1003 dans les rainures en forme de T des profilés aluminium :
Entrez la tête de vis dans la rainure du profilé et tournez à 90° afin qu'elle ne puisse pas sortir du profilé. Assemblez la/les pièce(s) nécessaire(s) et serrez l'écrou.

Verwendung der Schrauben 1002 und 1003 in den T-förmigen Nuten der Aluminiumprofile :
Schraubenkopf in die Profilmutter stecken und diesen um 90° drehen, damit er nicht aus dem Profil herauskommt. Bauen Sie das/die benötigte(n) Einzelteil(e) zusammen und ziehen Sie die Schraubenmutter an.

Principle of use of screws 1002 and 1003 in the T-shaped grooves of the aluminium profiles :
Enter the screw head into the groove of the profile and turn the screw head at 90° so that it cannot exit the profile. Assemble the required part(s) and tighten the screw nut.

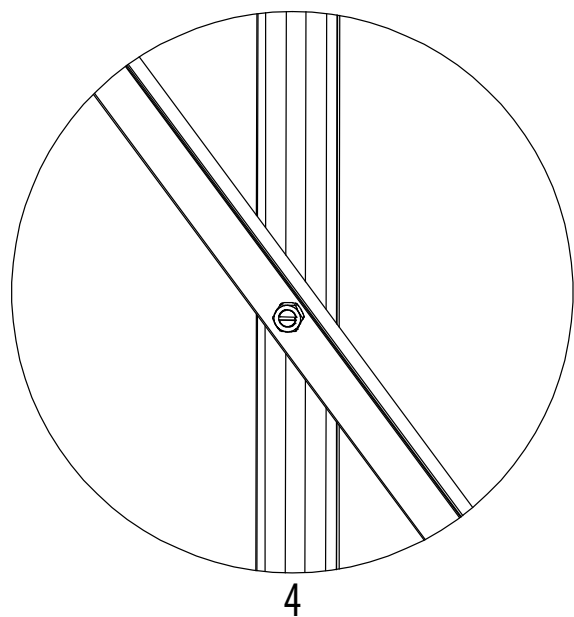
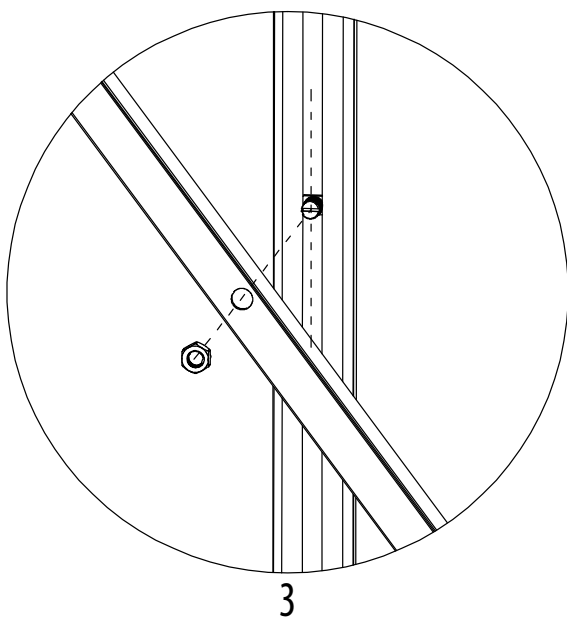
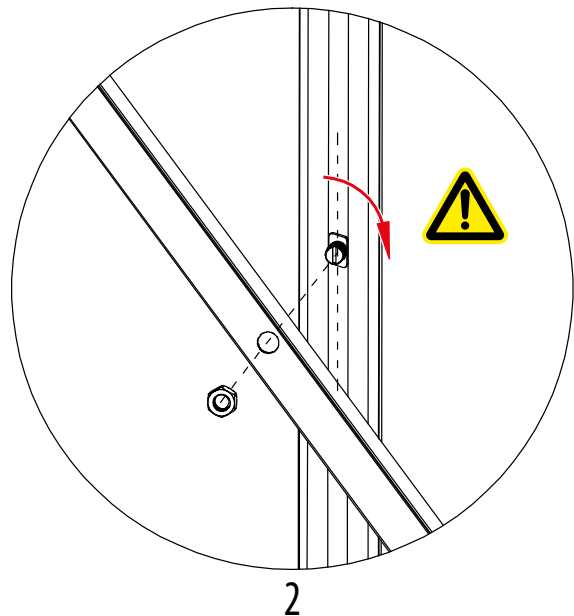
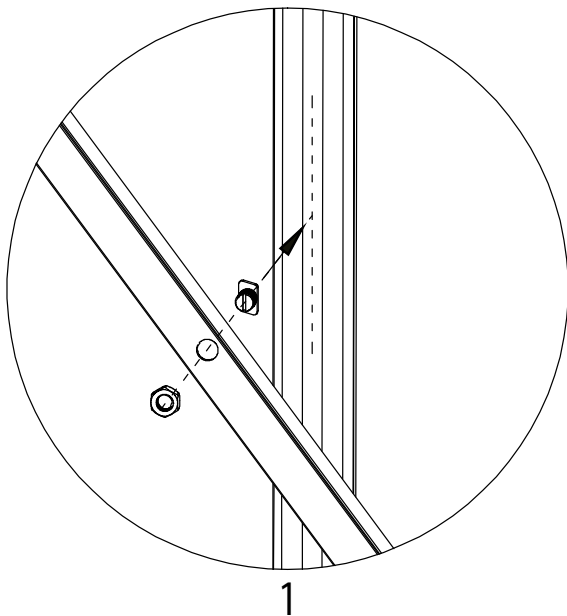

LONG-PAN (CÔTÉ) - SEITENWAND - SIDE WALL

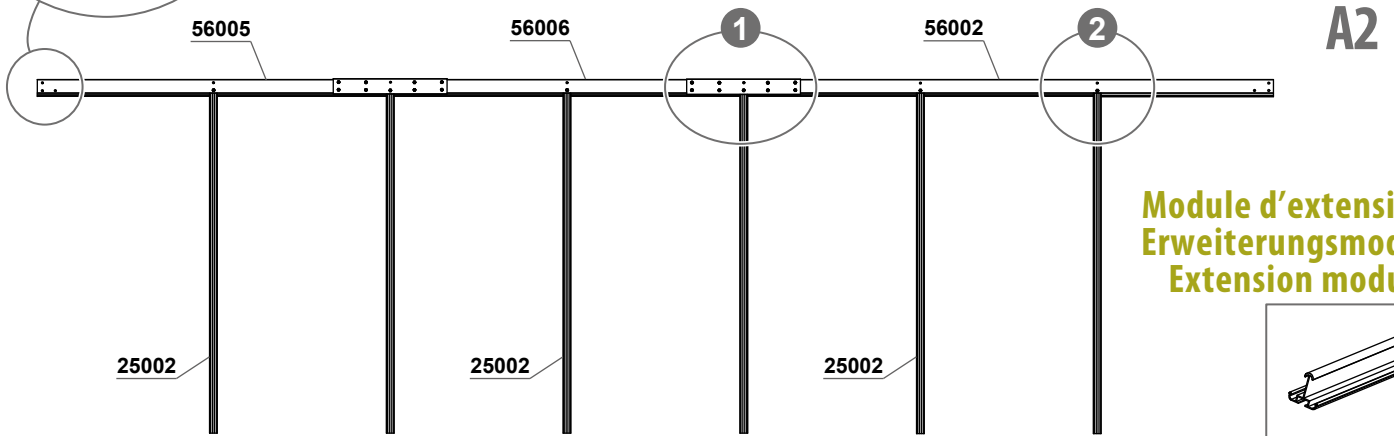
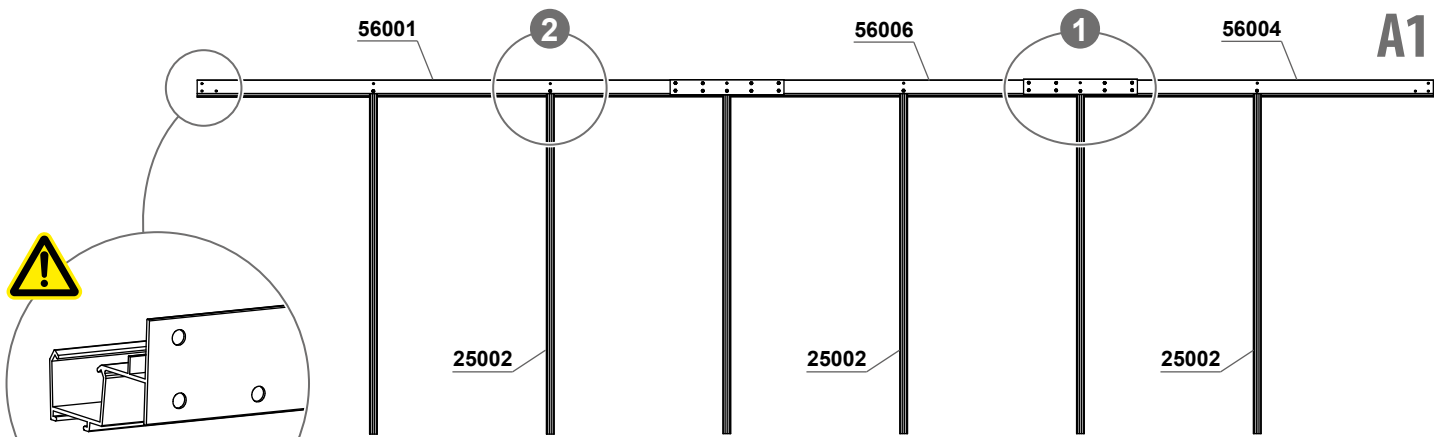

Module d'extension
Erweiterungsmodul
Extension module

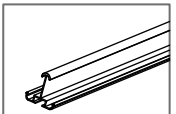

25002 x 4

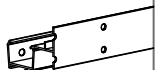

56006 x 2

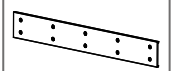

57001 x 2

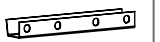

W002 x 2



1001 x 28

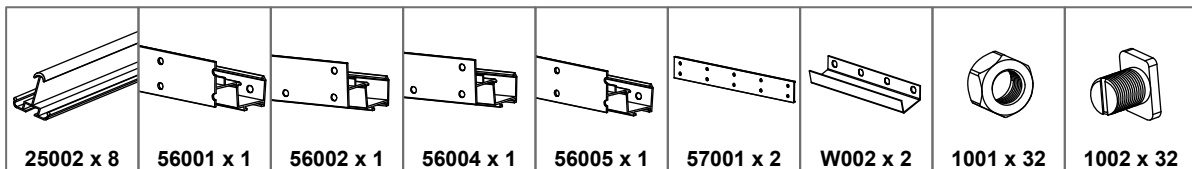
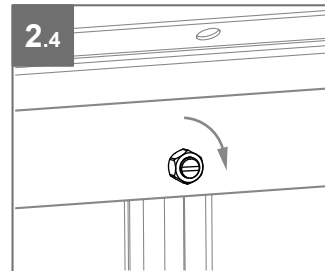
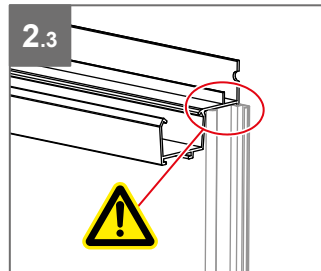
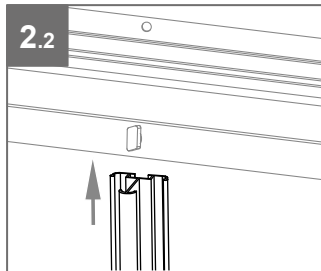
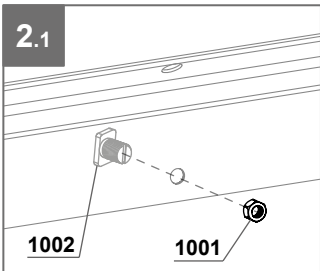
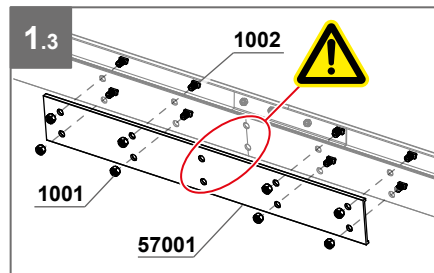
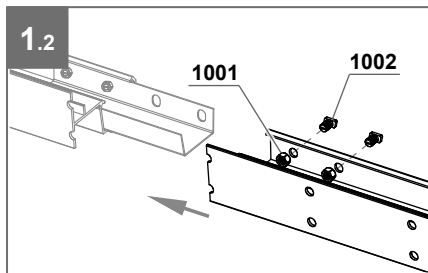
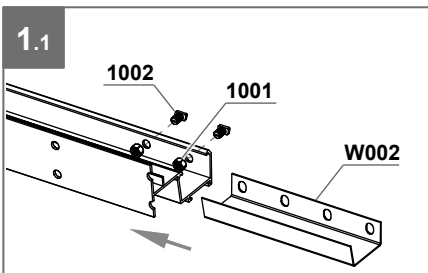



Module de base - Basismodul - Basic module

LONG-PAN (CÔTÉ) - SEITENWAND - SIDE WALL



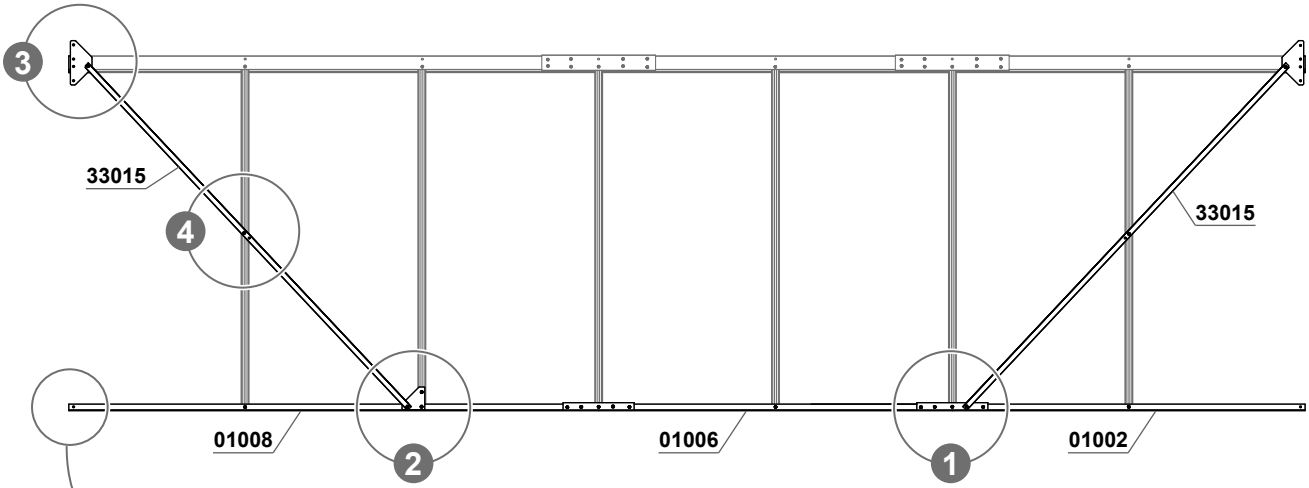

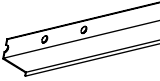
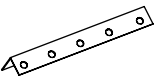

Module d'extension
Erweiterungsmodul
Extension module

A1

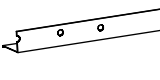

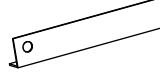
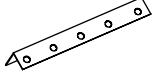
-  01006 x 1
-  46001 x 1
-  1001 x 6
-  1002 x 6

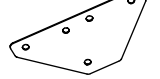
Module de base
Basismodul
Basic module

-  01002 x 1
-  01008 x 1
-  33015 x 2
-  46001 x 1
-  W003 x 1
-  W023 x 2
-  1001 x 14
-  1002 x 14

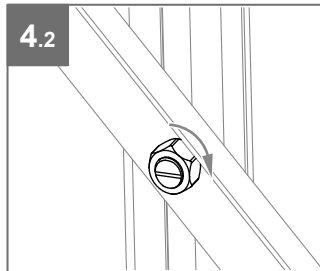
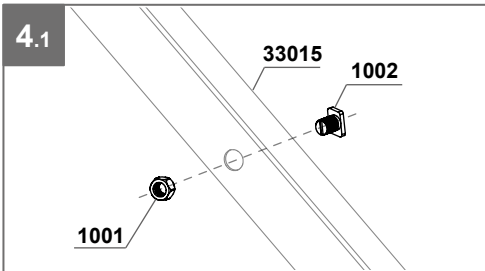
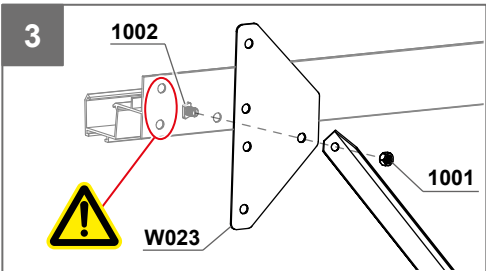
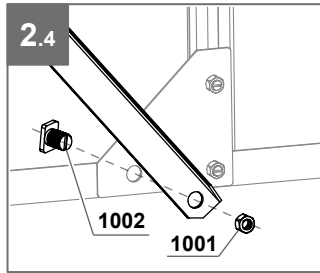
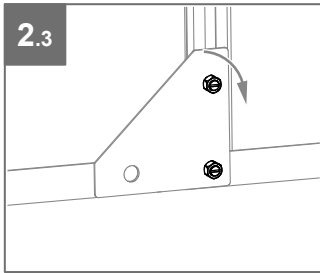
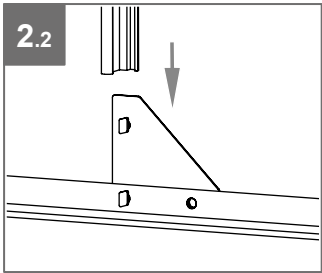
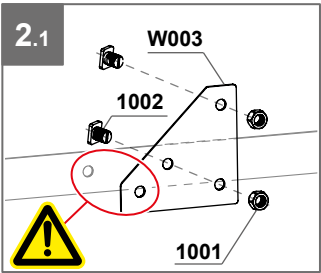
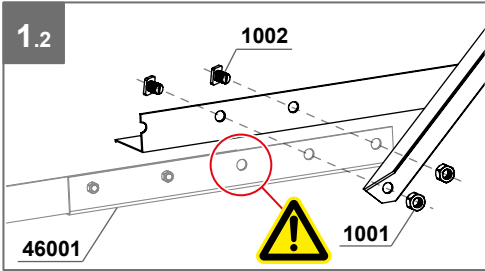
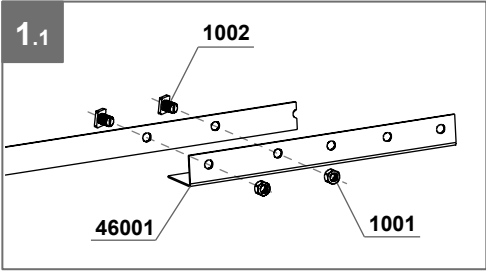
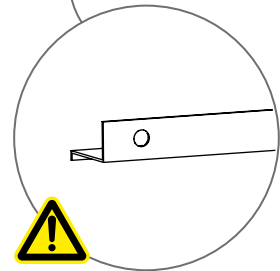



LONG-PAN (CÔTÉ) - SEITENWAND - SIDE WALL



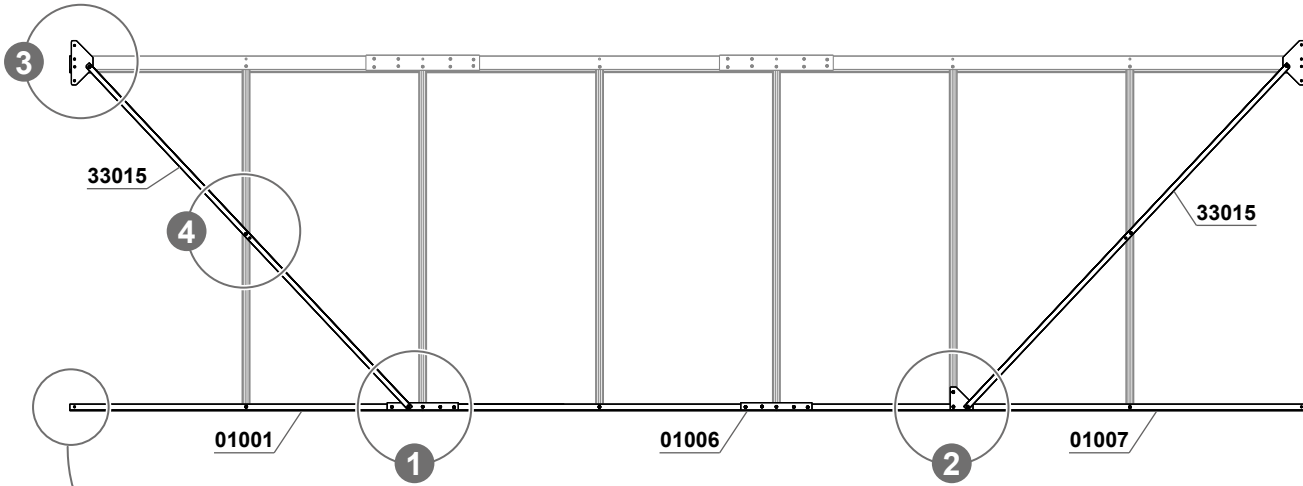

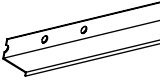
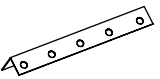
Module d'extension
Erweiterungsmodul
Extension module

A2

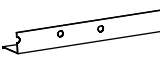
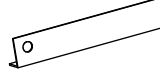
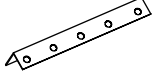

-  01006 x 1
-  46001 x 1
-  1001 x 6
-  1002 x 6

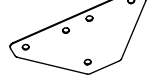
Module de base
Basismodul
Basic module

-  01001 x 1
-  01007 x 1
-  33015 x 2
-  46001 x 1
-  W003 x 1
-  W023 x 2
-  1001 x 14
-  1002 x 14

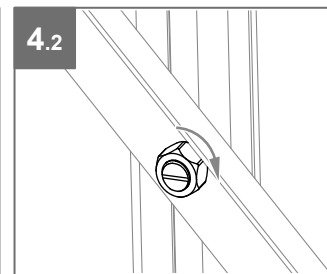
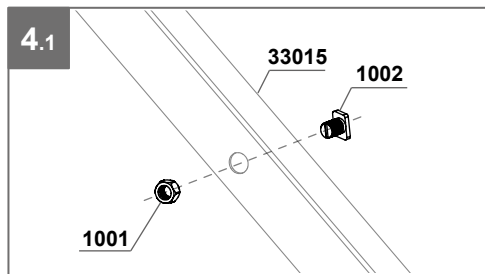
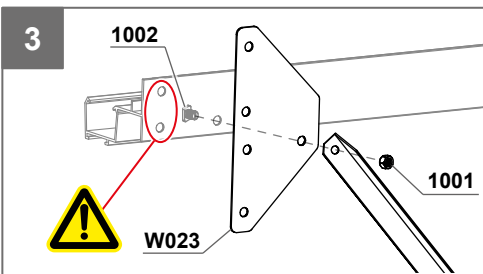
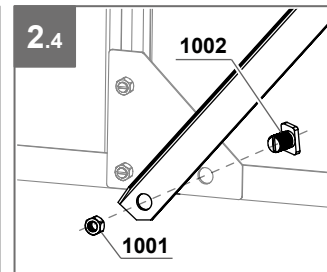
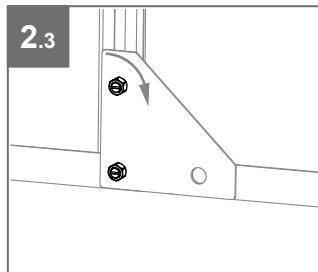
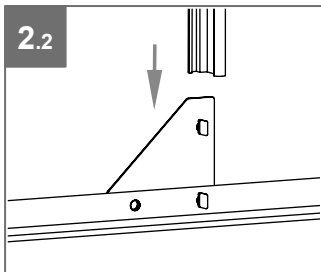
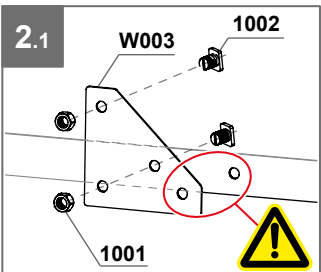
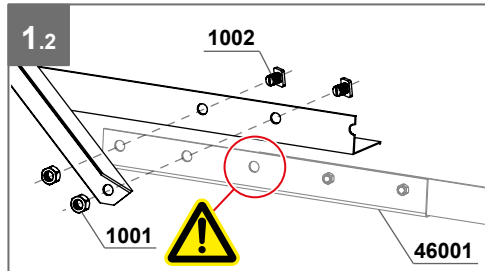
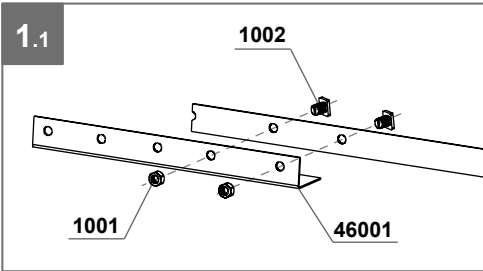

ÉTAPES SUIVANTES - NÄCHSTE SCHRITTE - NEXT STEPS

Montage de la face avant (avec porte) : pages 17-19
Montage der Vorderwand (mit Tür) : Seiten 17-19
Assembling the front wall (with door) : pages 17-19

Montage de la face arrière (sans porte) : pages 20-22
Montage der Rückwand (ohne Tür) : Seiten 20-22
Assembling the rear wall (without door) : pages 20-22

Montage de la porte : pages 23-24
Montage der Tür : Seiten 23-24
Assembling the door : pages 23-24

Montage de la lucarne : page 25
Montage des Fensters : Seite 25
Assembling the window : page 25

Puis revenir à la page 48
Dann zurück auf Seite 48
Then back to page 48

ASSEMBLAGE DES PAROIS - ZUSAMMENBAU DER WÄNDE

ASSEMBLY OF THE WALLS

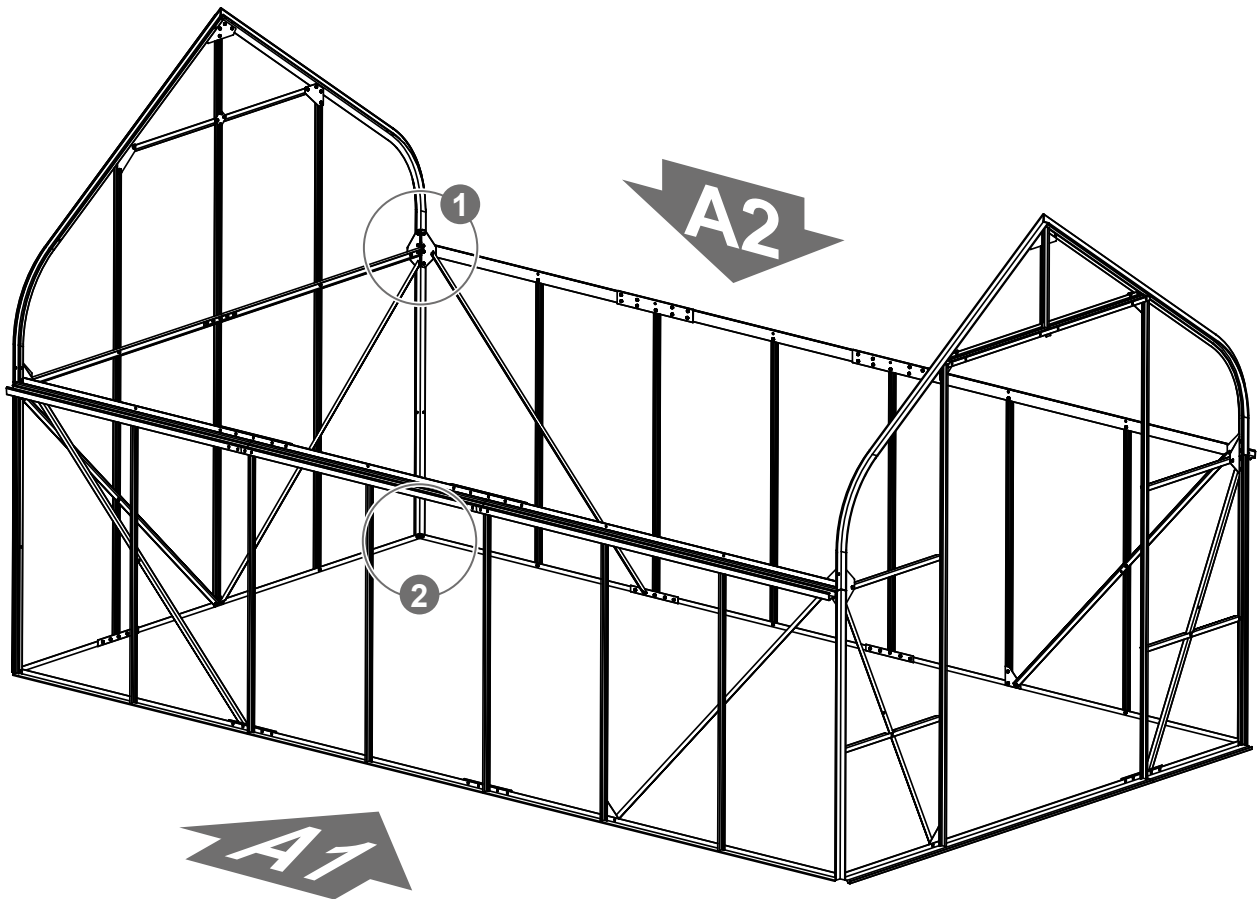

Module de base
Basismodul
Basic module

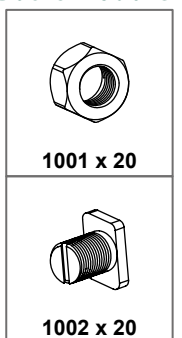
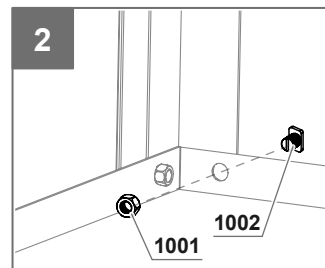
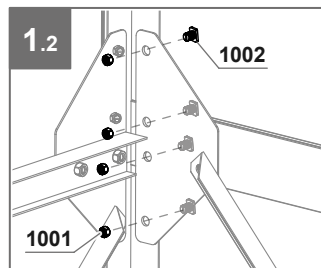
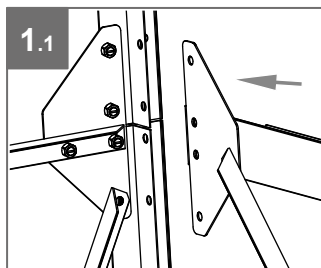
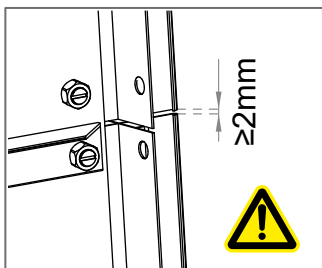

MONTAGE DES PROFILÉS DE TOITURE - MONTAGE DER DACHPROFILE ASSEMBLING THE ROOF PROFILES

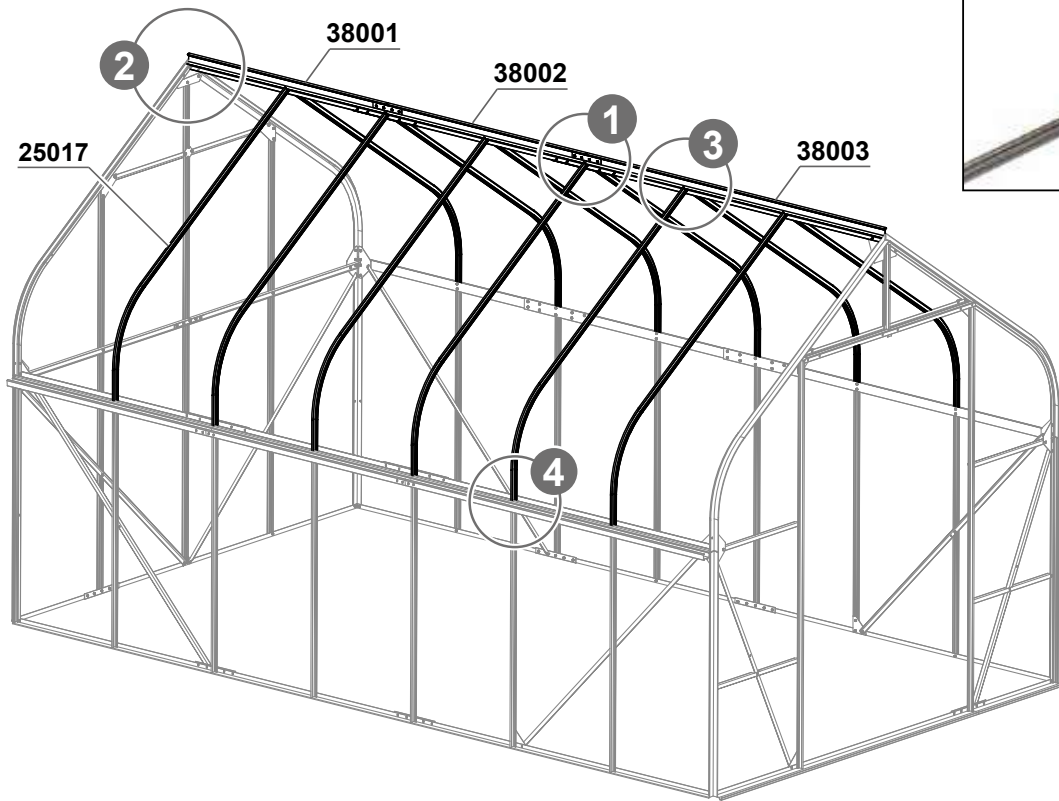

Module de base
Basismodul
Basic module

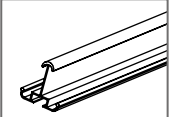

25017 x 8

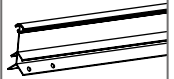

38001 x 1

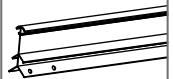

38003 x 1

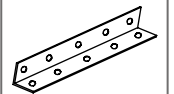

45001 x 1

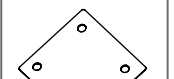

W003 x 4

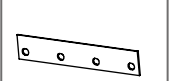

W004 x 2



1001 x 36

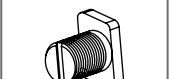

1002 x 28

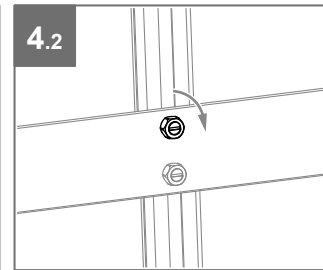
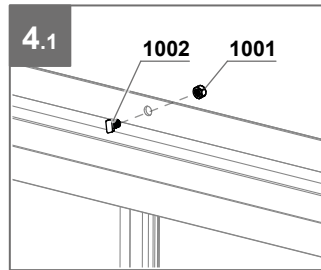
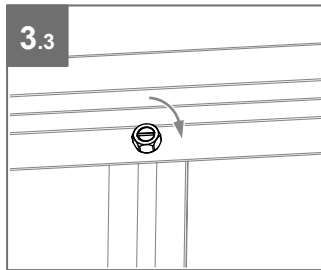
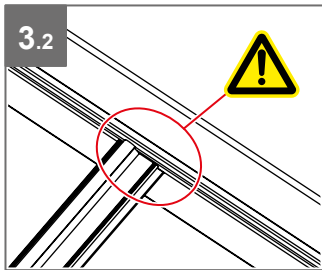
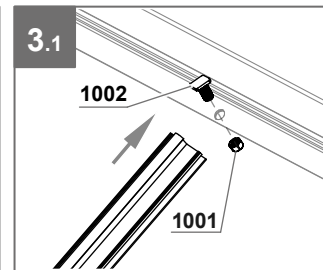
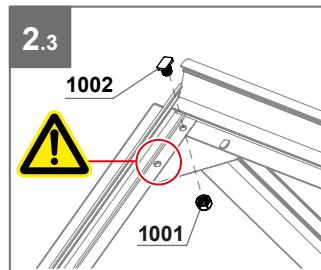
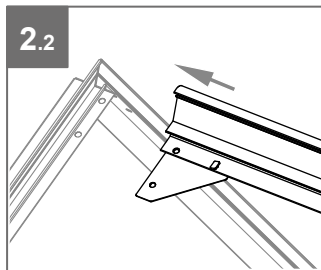
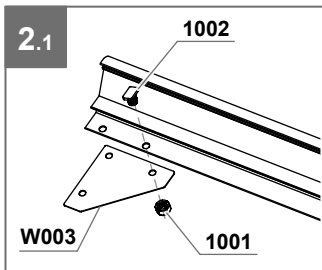
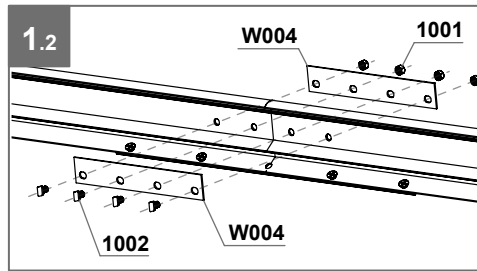
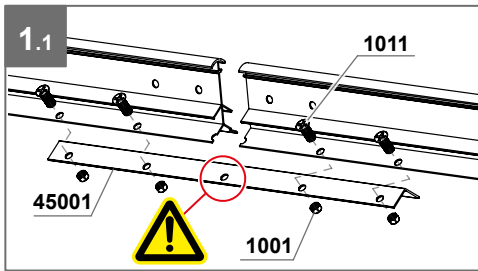

Module d'extension
Erweiterungsmodul
Extension module



25017 x 4

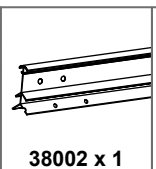

38002 x 1

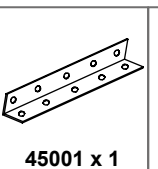

45001 x 1

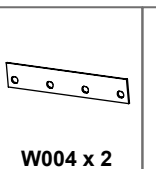

W004 x 2

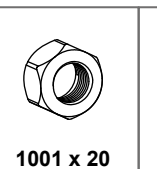

1001 x 20

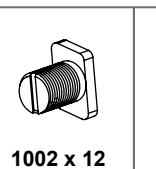

1002 x 12

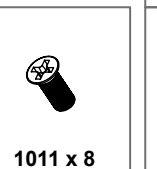

1011 x 8



1011 x 8

MONTAGE DES PROFILÉS DE TOITURE - MONTAGE DER DACHPROFILE ASSEMBLING THE ROOF PROFILES

Module de base Basismodul Basic module

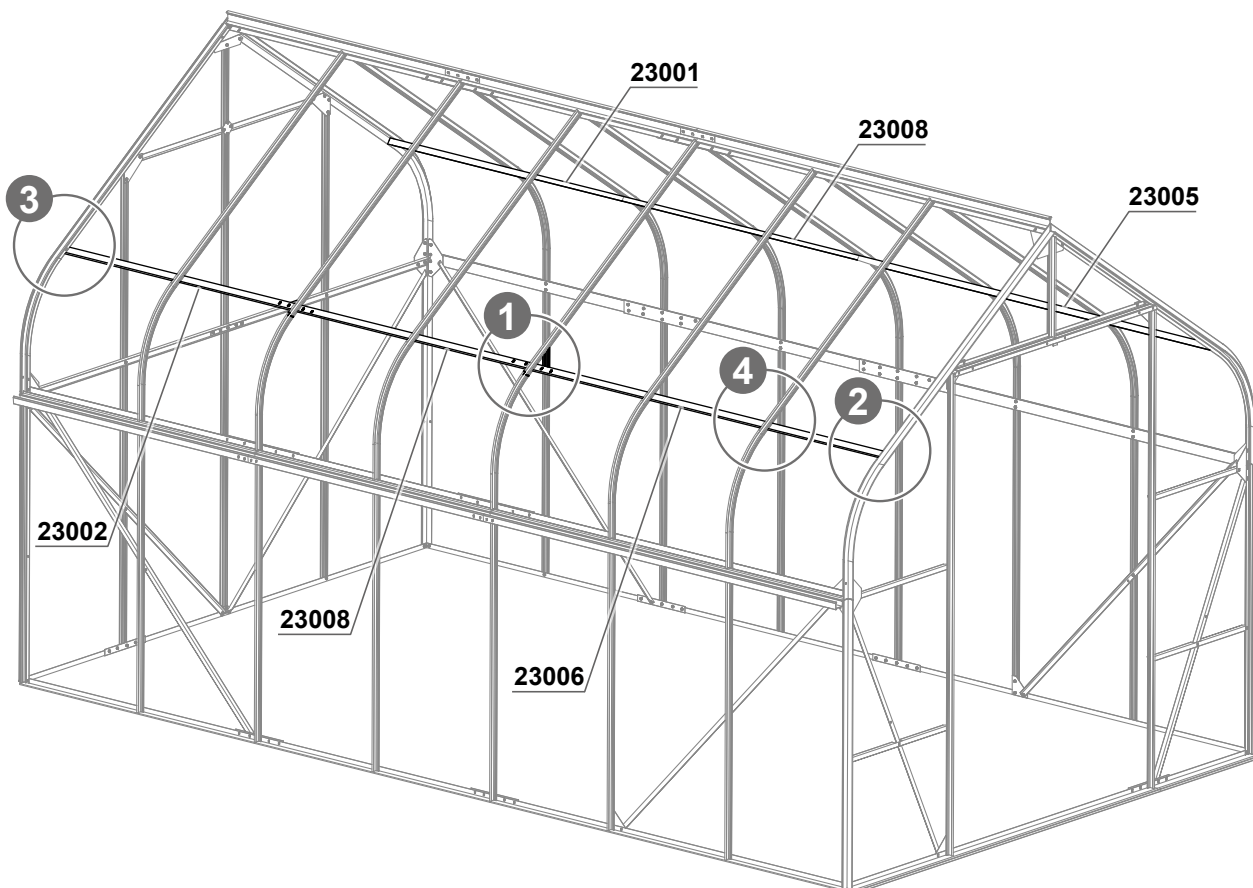

	23001 x 1
	23002 x 1
	23005 x 1
	23006 x 1
	46002 x 2
	1001 x 20
	1002 x 20

Module d'extension Erweiterungsmodul Extension module

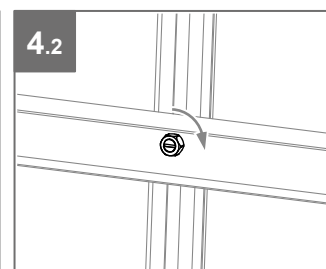
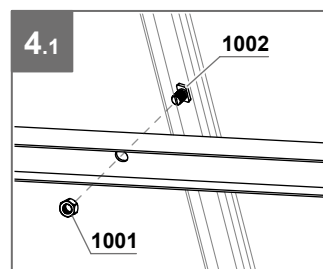
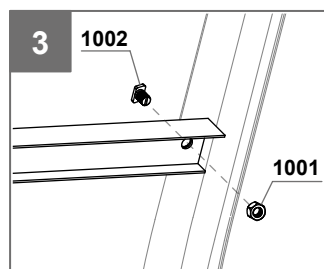
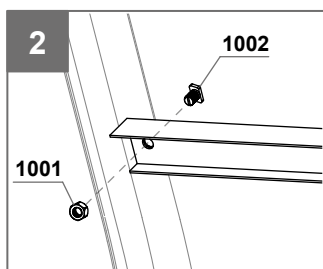
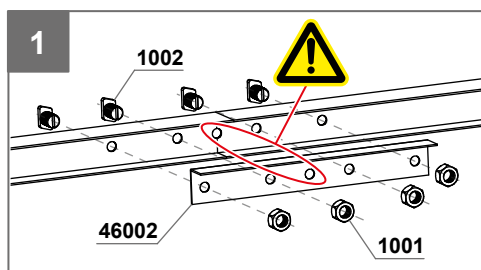

	23008 x 2
	46002 x 2
	1001 x 12
	1002 x 12

MONTAGE DES TENDEURS ET GOUSSETS SPANNVORRICHTUNG UND VERBINDER WIND BRACES AND GUSSETS

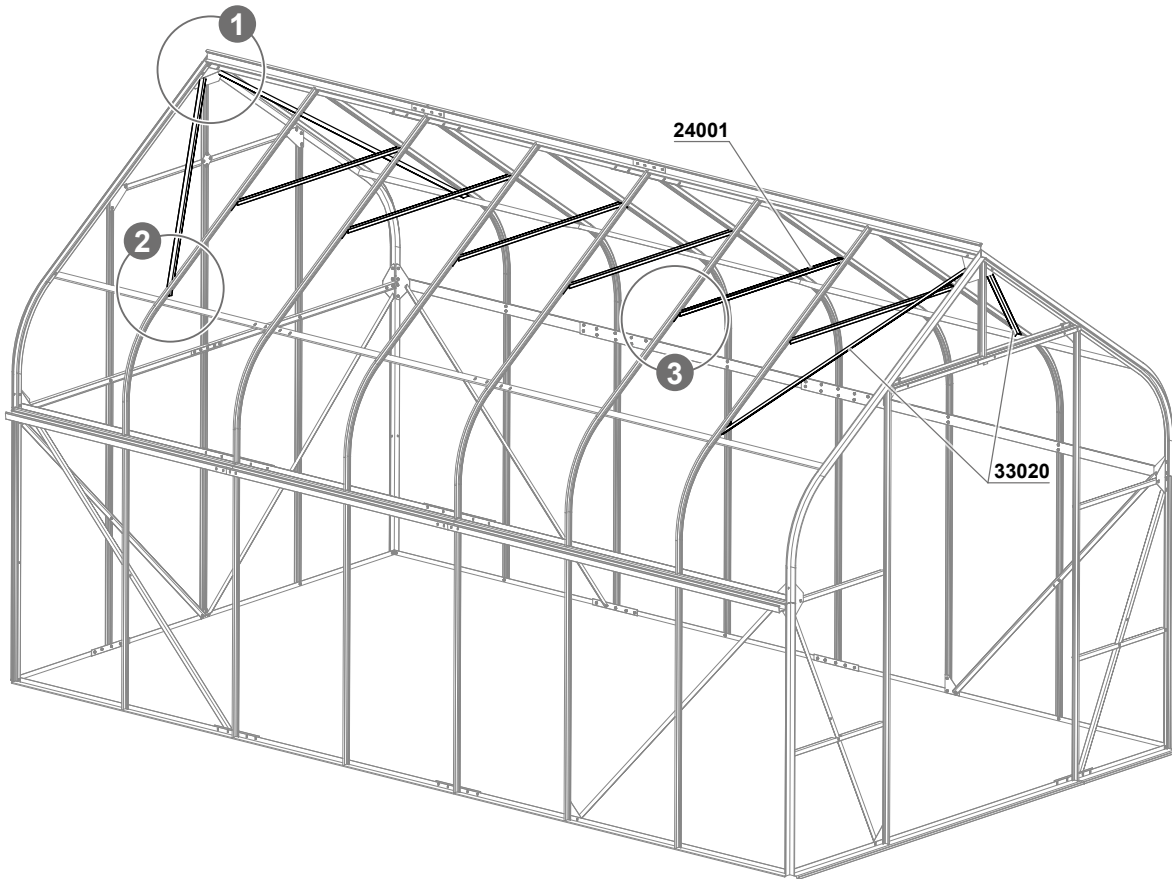

Module d'extension Erweiterungsmodul Extension module

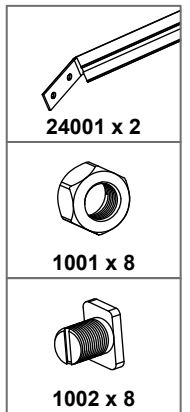

Module de base Basismodul Basic module

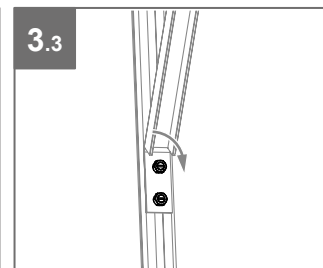
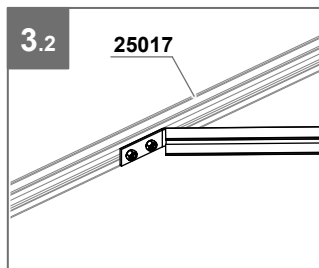
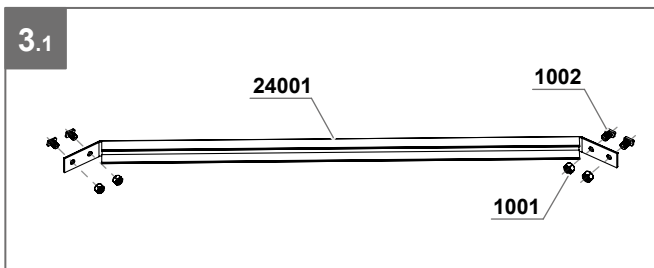
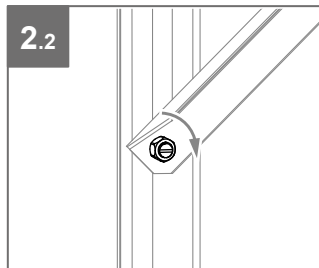
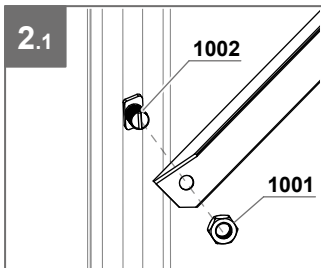
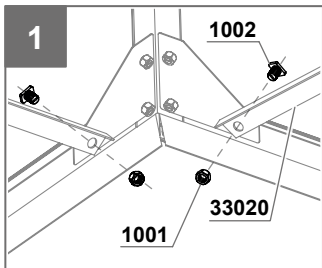
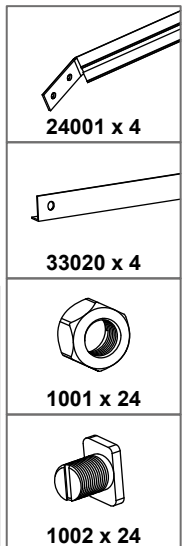

FIXATION DE LA SERRE SUR LA BASE BEFESTIGUNG DES GEWÄCHSHAUSES AM FUNDAMENTRAHMEN FASTENING THE GREENHOUSE BASE

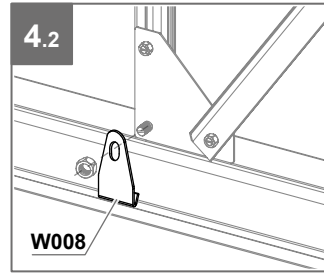
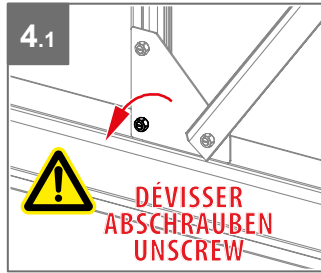
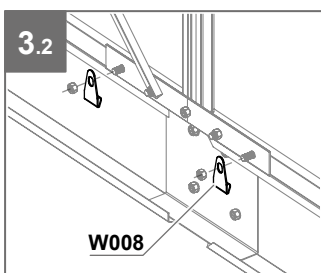
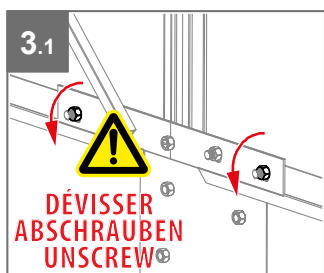
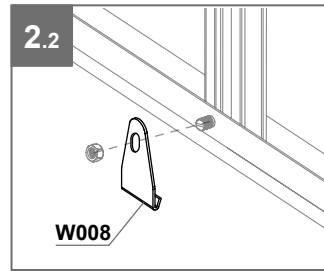
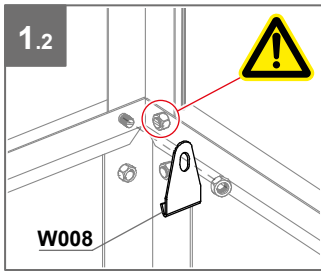
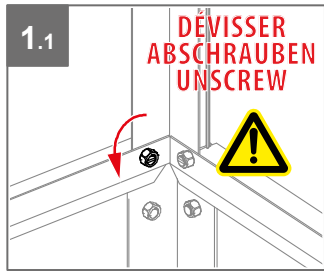
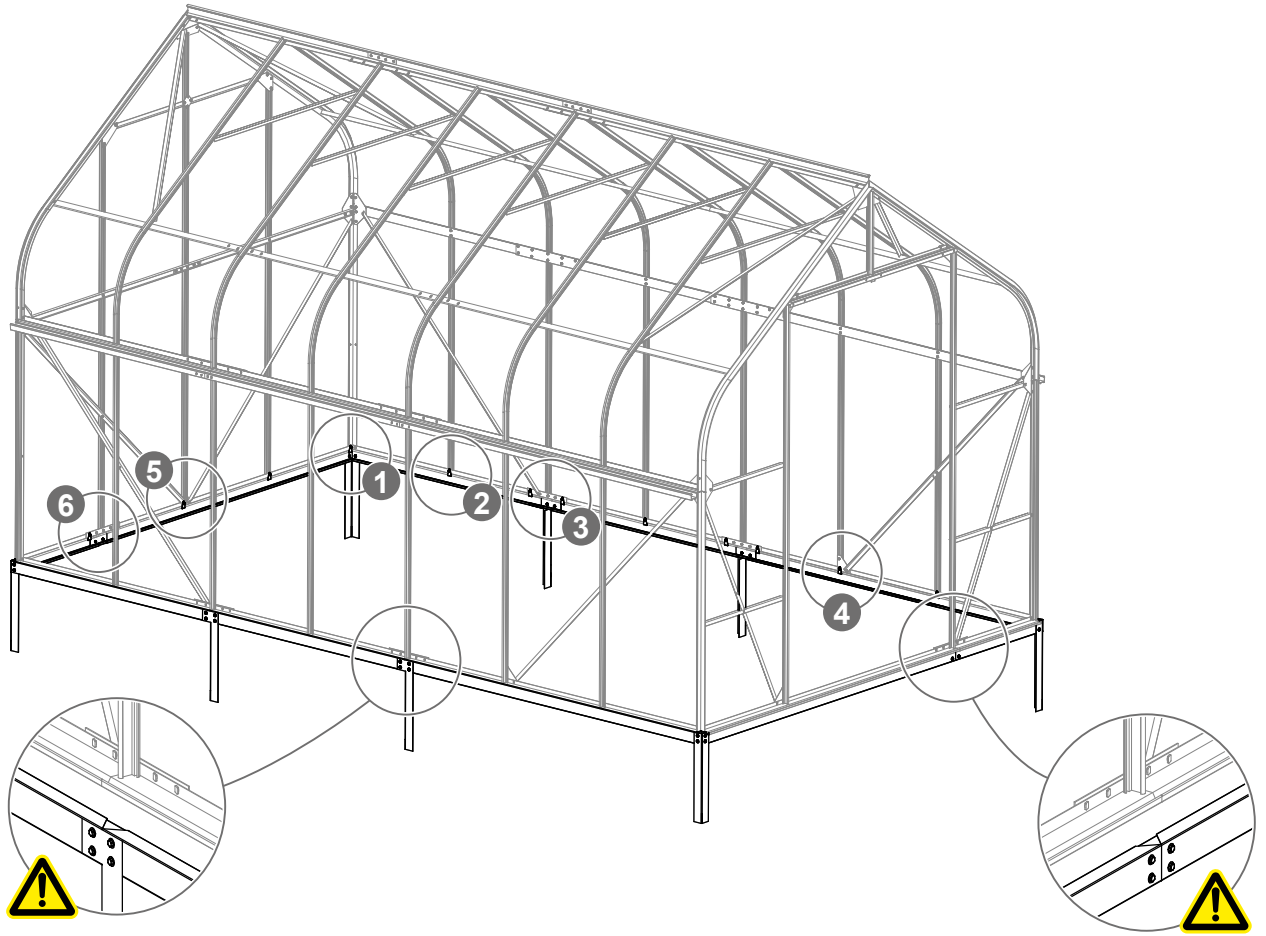

Module d'extension
Erweiterungsmodul
Extension module

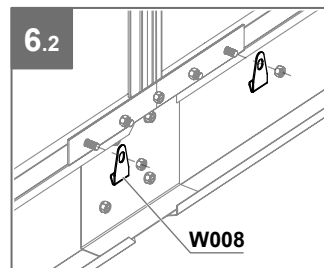
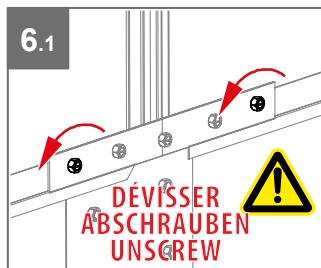
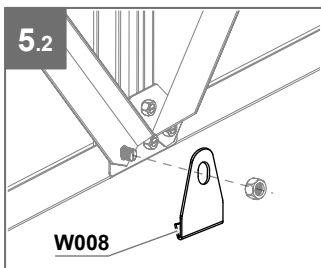
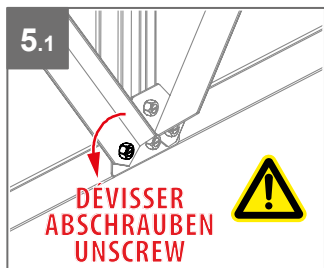
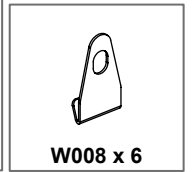

Module de base
Basismodul
Basic module

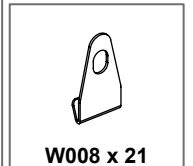

MONTAGE PORTE + RAIL MONTAGE TÜR + SCHIENE ASSEMBLING DOOR + RAIL



Recommandation : graissage régulier du rail
Empfehlung : Schiene regelmäßig schmieren
Recommendation : grease rail regularly

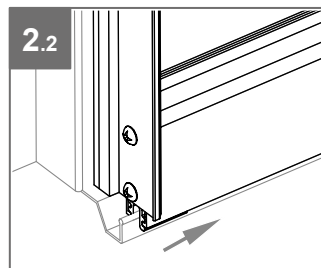
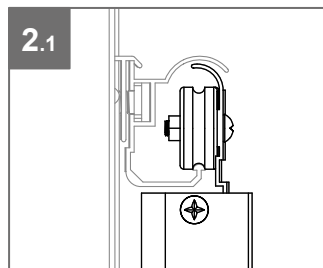
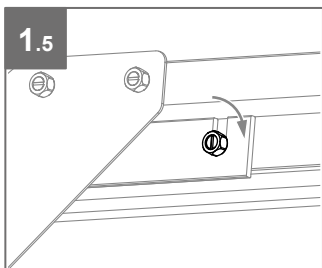
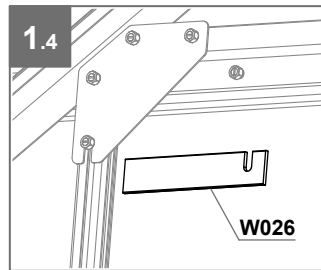
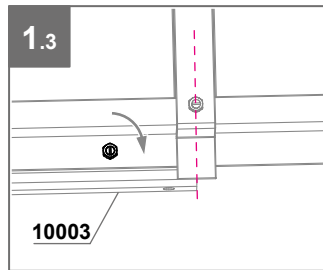
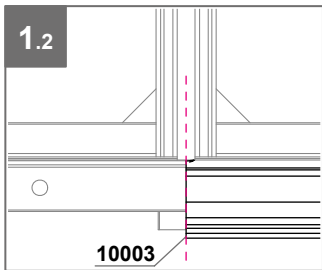
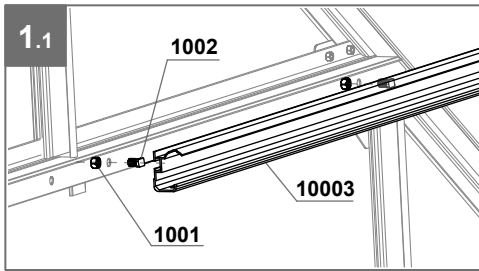
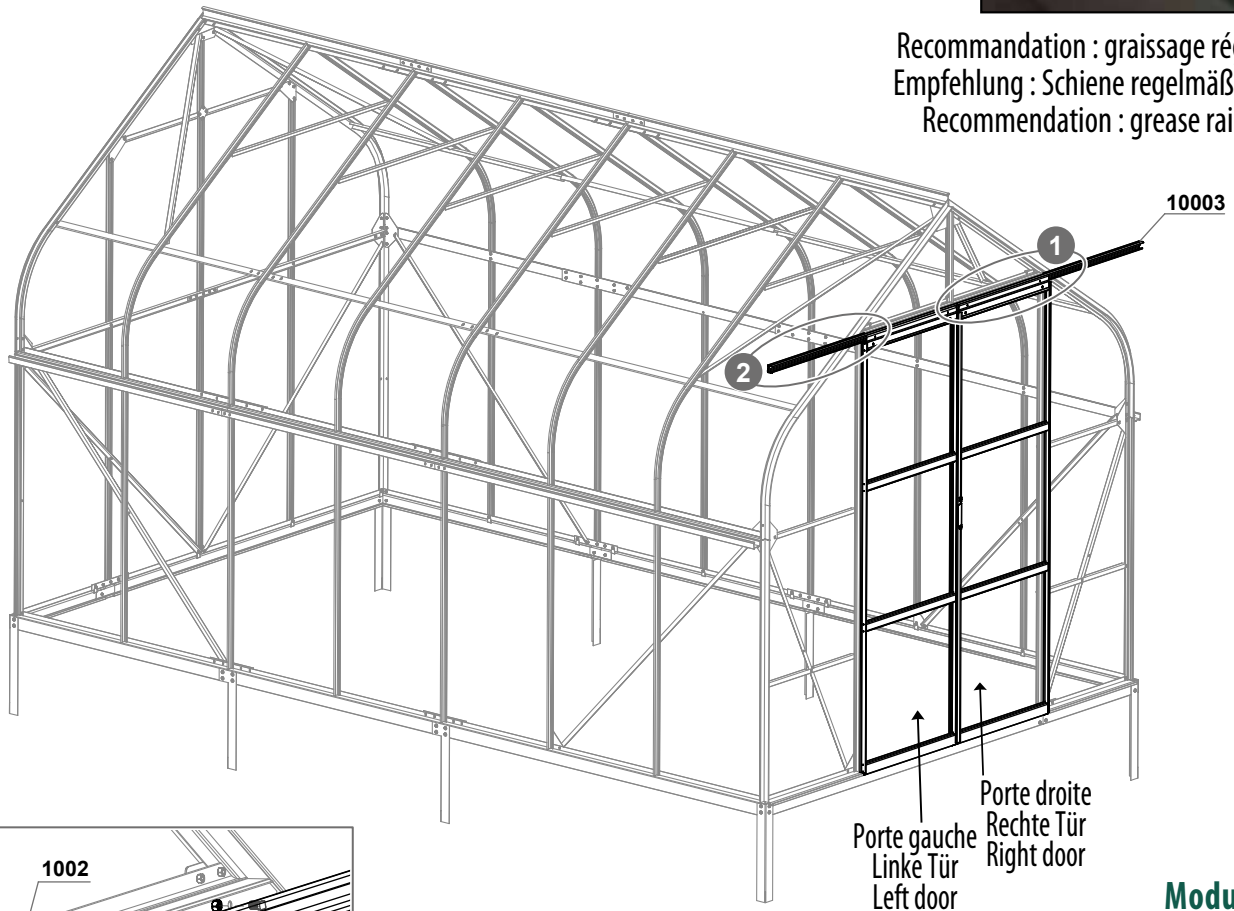

Module de base Basismodul Basic module



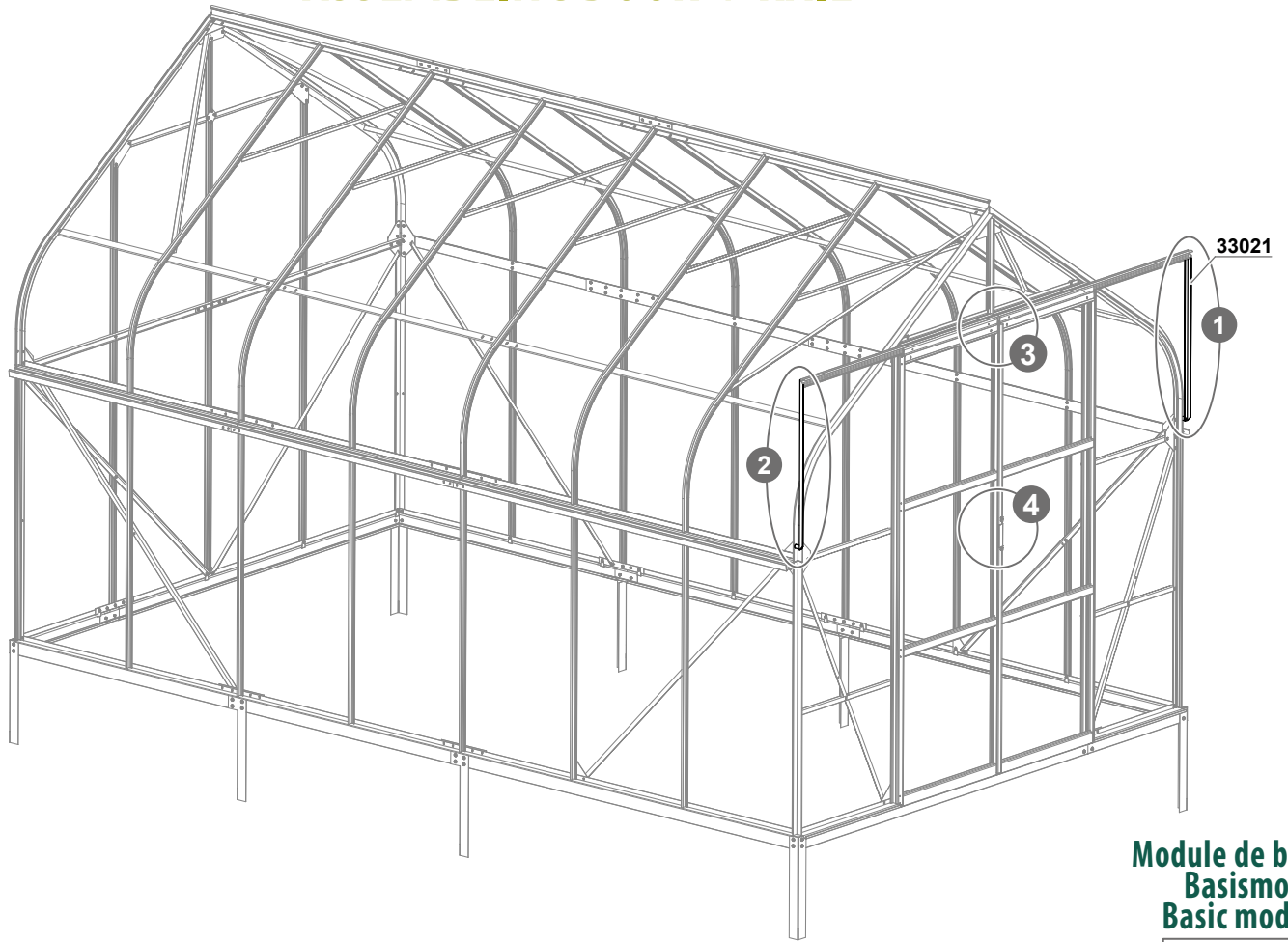

	10003 x 2
	1001 x 4
	1002 x 4
	W026 x 2

MONTAGE PORTE + RAIL MONTAGE TÜR + SCHIENE ASSEMBLING DOOR + RAIL

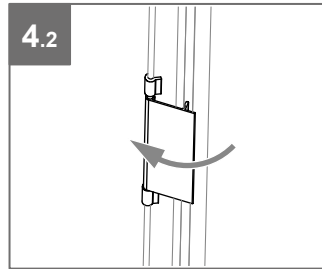
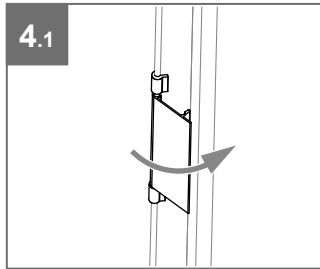
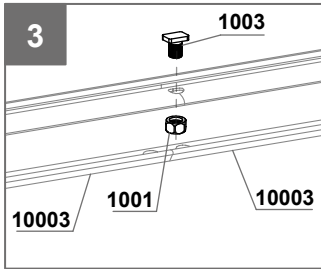
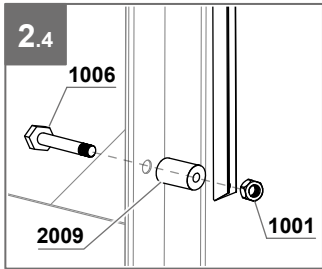
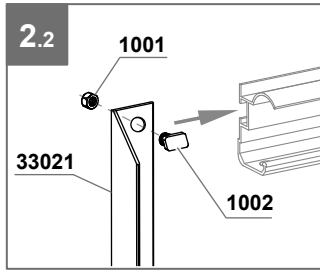
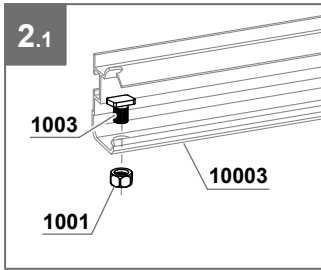
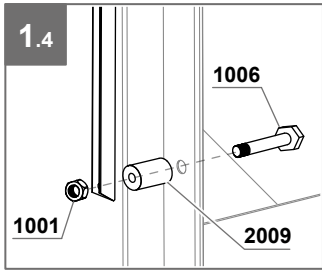
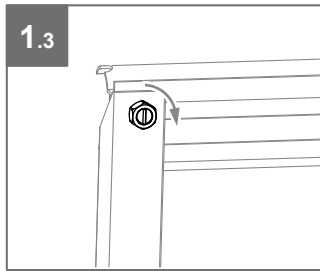
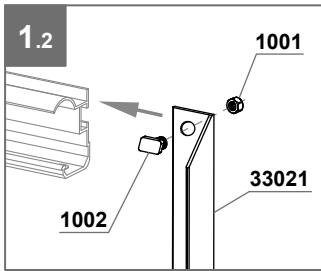
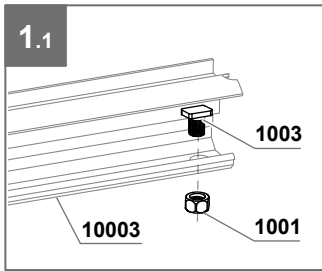

Module de base
Basismodul
Basic module

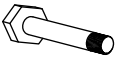

-  33021 x 2
-  1001 x 7
-  1002 x 2
1003 x 3
-  1006 x 2
-  2009 x 2

VITRAGE - VERGLASUNG - GLAZING

Nous vous conseillons d'installer les verres niveau par niveau (du bas vers le haut).



Wir empfehlen Ihnen, die Gläser Ebene für Ebene anzubringen (von unten nach oben).

We advise you to install the glazing level by level (from bottom to top).



Crochets de vitrage
Verglasungshaken
Glazing hooks



Clips de vitrage
Gewächshausklammern
Glazing clips

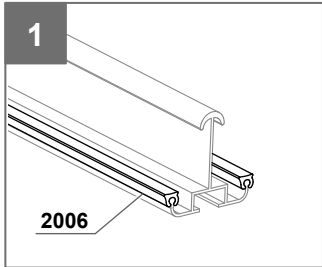

1 Pose du joint. Voir page 33. Puis continuez.
Dichtung anbringen (s. S. 33). Dann fortfahren.
Attach seal (s. p. 33). Then continue.

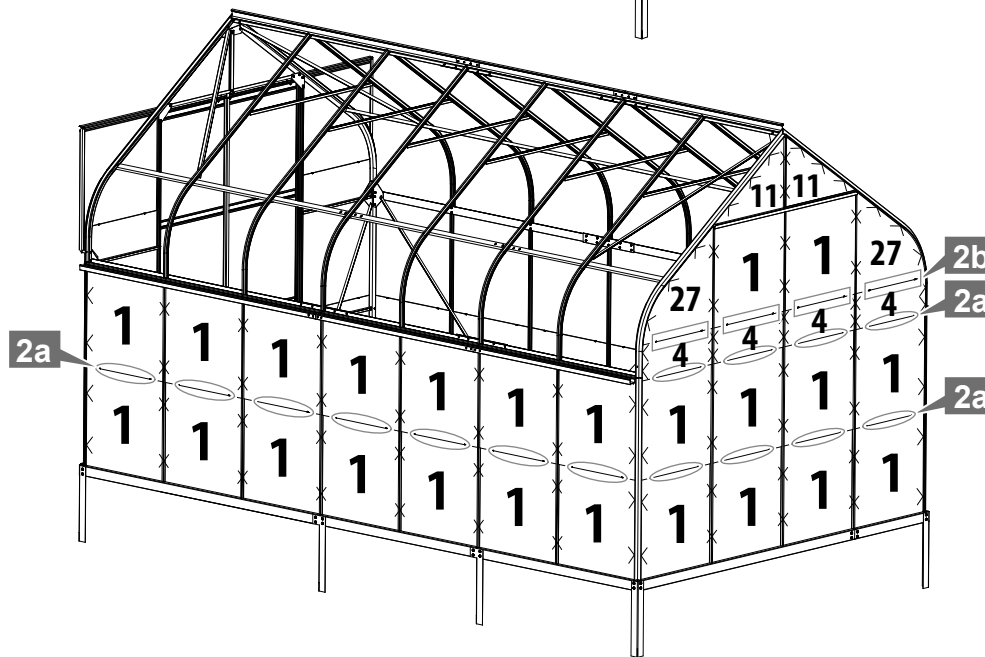
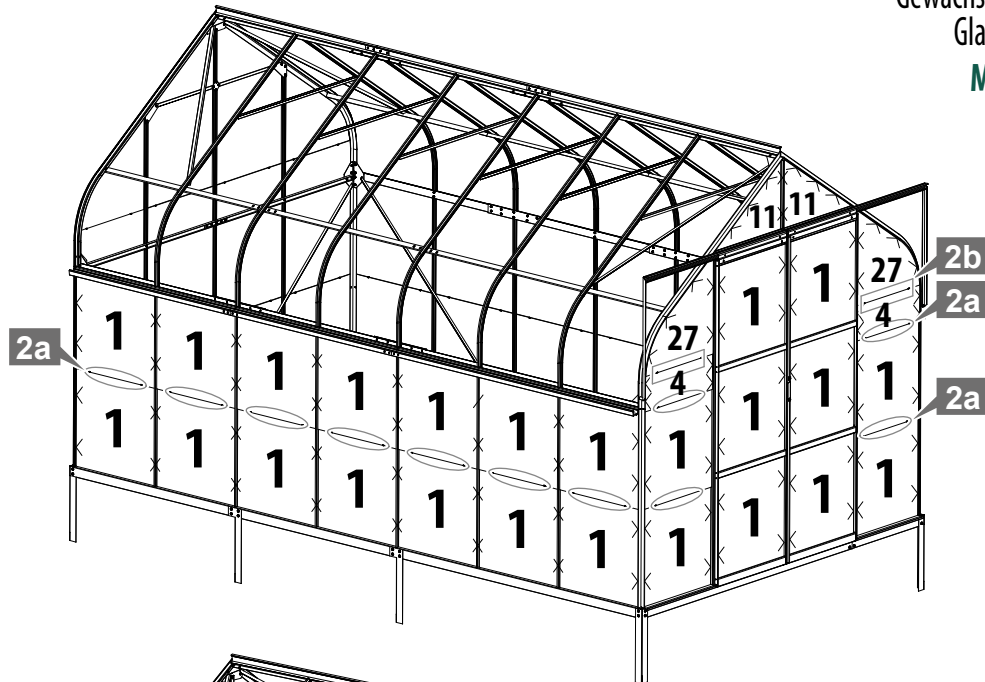
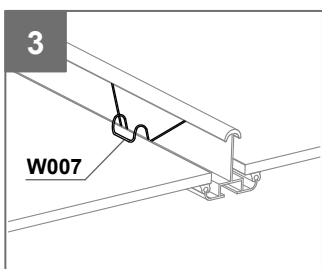
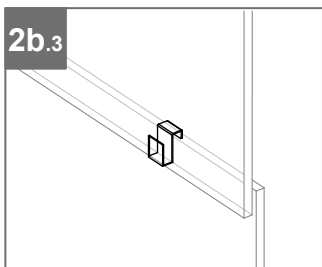
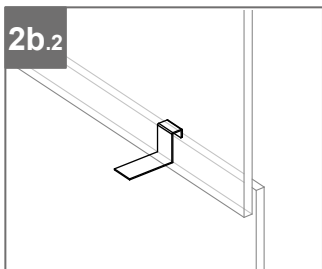
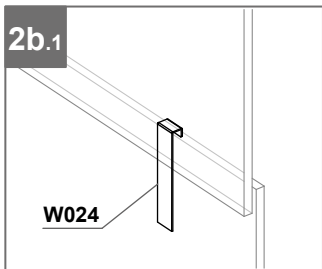
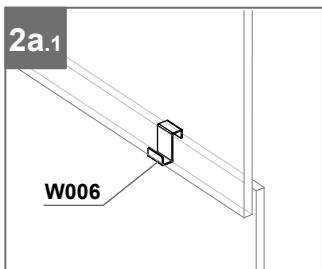

Module de base Basismodul Basic module

610 x 610 1 x 40
610 x 229 4 x 6
610 x 434/8 11 x 4
610 x 610 27 x 4
 2006 x 100m
 W006 x 44
 W007 x 224
 W024 x 12

Module d'extension Erweiterungsmodul Extension module

610 x 610 1 x 8	 2006 x 25m	 W006 x 8	 W007 x 32	 W024 x 12
------------------------	----------------	--------------	---------------	---------------

VITRAGE + POSE LUCARNES

VERGLASUNG + FENSTERN EINBAUEN

GLAZING + INSTALLING WINDOWS



Lucarne - vue extérieure
 Fenster - Außenansicht
 Window - exterior view

Module de base Basismodul Basic module



1
 Pose de la lucarne sur faîtière
 par glissement.
 Anbringung des Fensters auf
 First durch Gleiten.
 Installing the window on
 roof ridge through sliding.

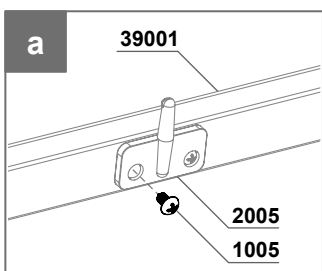
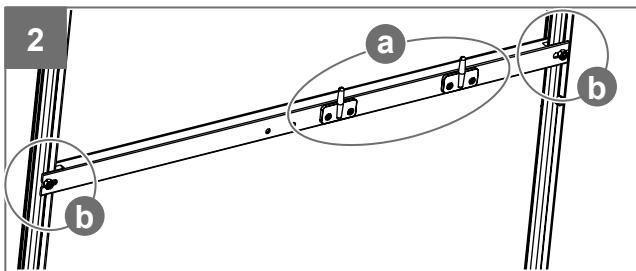
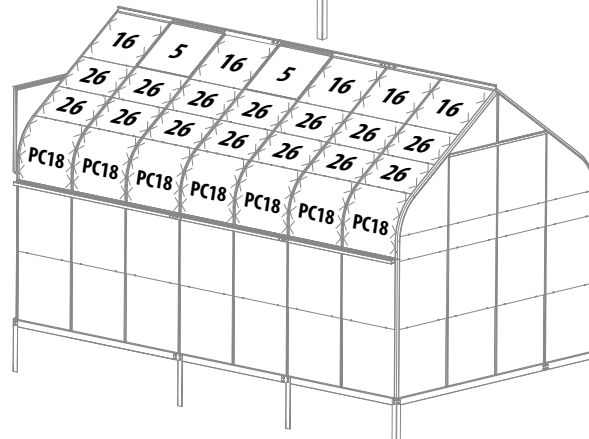
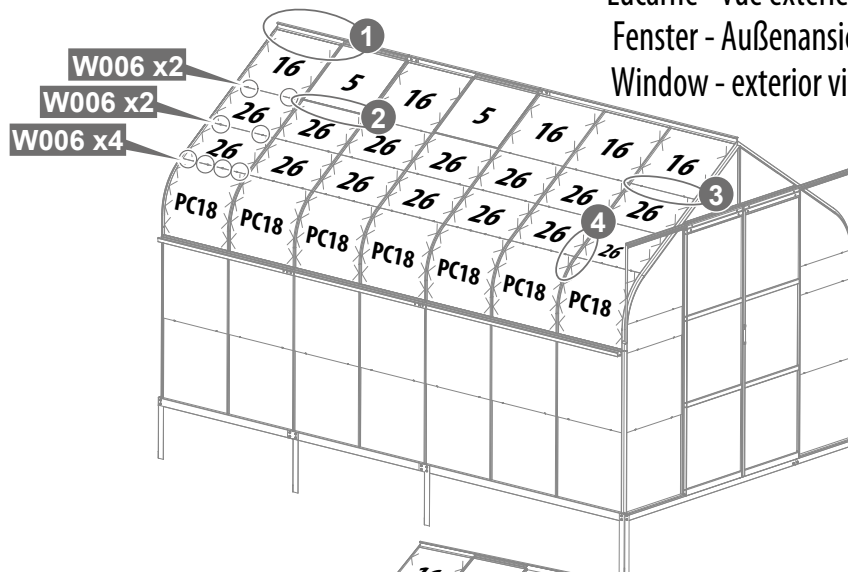

Dichtung schneiden um Einzelteil 39001 durchzulassen.
 Cut the seal to let part 39001 through.

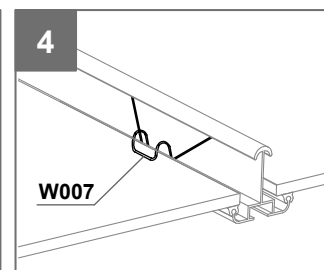
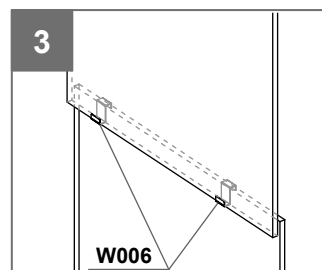
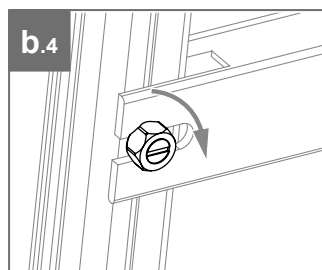
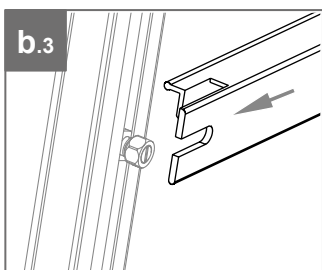
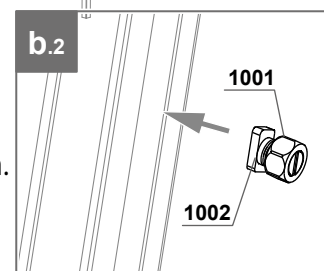

Module d'extension - Erweiterungsmodul - Extension module

610 x 549 16 x 2	610 x 375 26 x 8	610 x 610 PC18 x 4	39001 x 2	1001 x 4	1002 x 4	1005 x 8	2005 x 4	W006 x 28	W007 x 72
---------------------	---------------------	-----------------------	-----------	----------	----------	----------	----------	-----------	-----------

610 x 549 16 x 8	610 x 375 26 x 20	610 x 610 PC18 x 10	39001 x 2	1001 x 4	1002 x 4	1005 x 8	2005 x 4	W006 x 76	W007 x 192
---------------------	----------------------	------------------------	-----------	----------	----------	----------	----------	-----------	------------

MONTAGE DES PIÈCES PLASTIQUES

MONTAGE DER KUNSTSTOFFTEILE

INSTALLING THE PLASTIC PARTS



Détail embout de faitière (pièce 2010)
 Abdeckung der Firstspitze (Einzelteil 2010)
 Roof ridge end cover (part 2010)

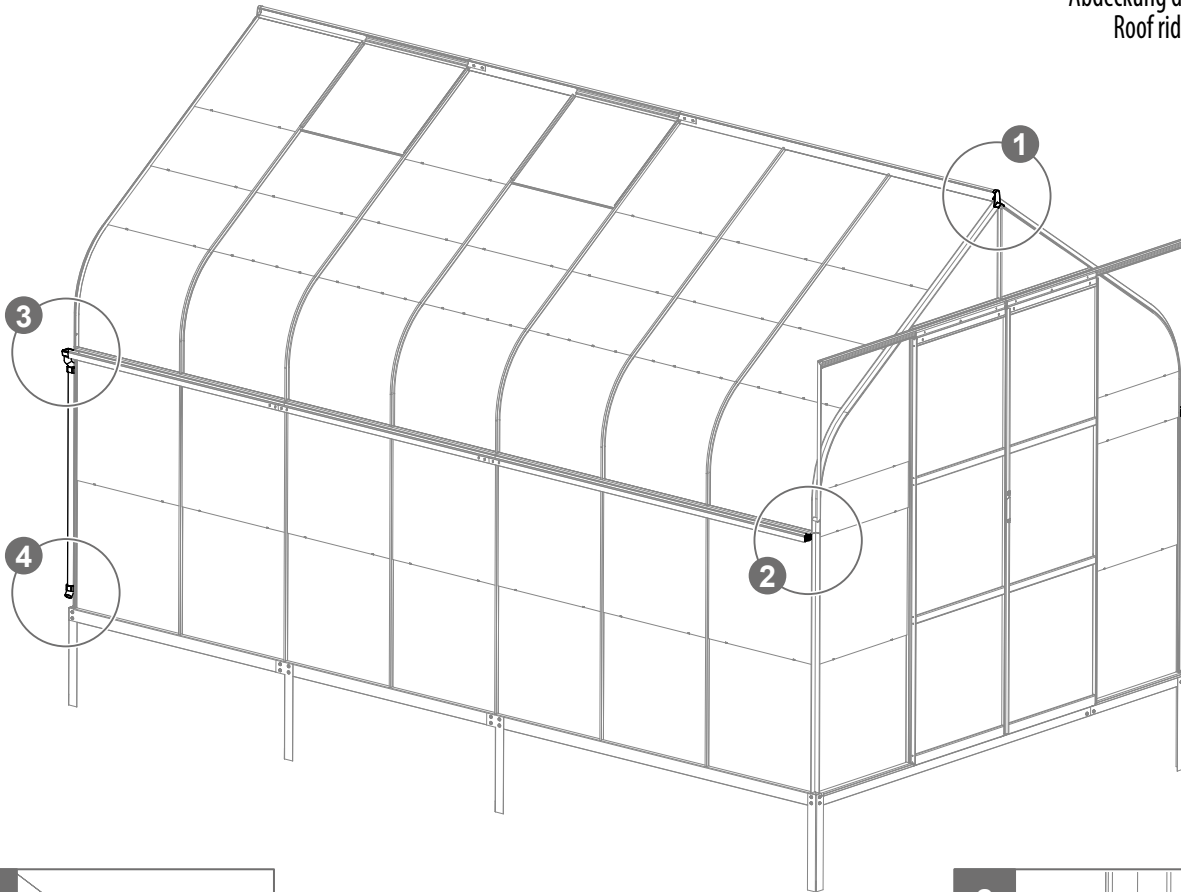

Module de base Basismodul Basic module

	1005 x 4
	2010 x 2
	2022 x 2
	2023 x 2
	2028 x 6
	2033 x 2
	2038 x 2
	58001 x 4

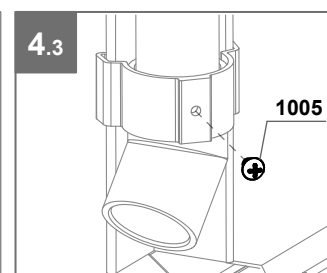
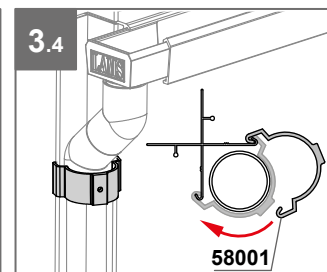
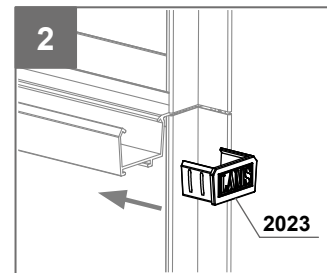
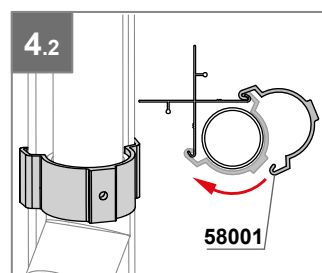
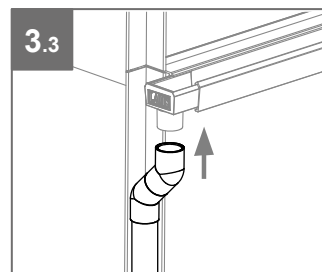
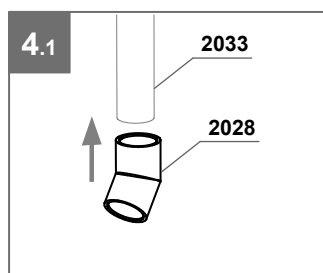
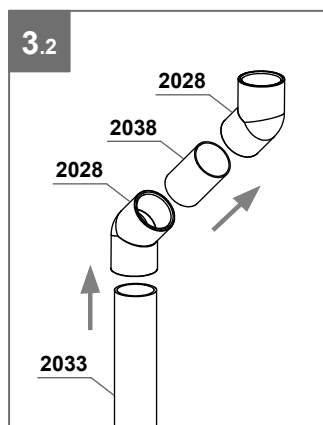
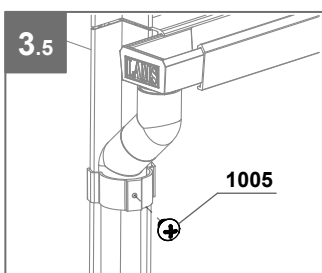
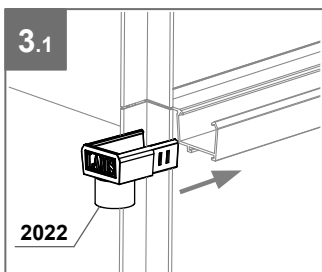
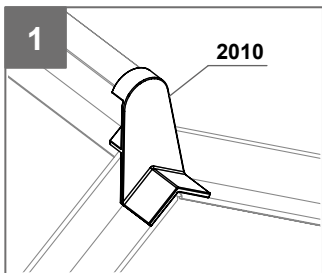

SERRE - GEWÄCHSHAUS - GREENHOUSE

ALOÉ 12,90 M²

Module de base 8,10 m² + module d'extension 4,80 m²











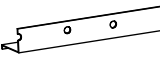

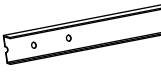

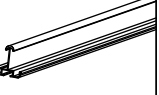
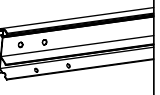
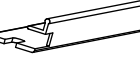



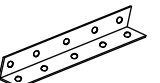
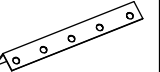
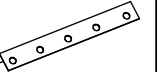
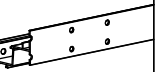
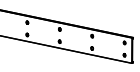
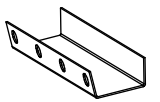
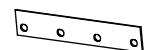
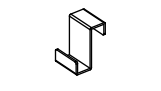

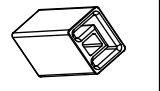

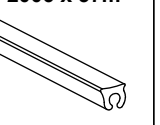
Basismodul 8,10 m² + Erweiterungsmodul 4,80 m²

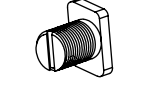
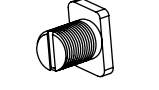
Basic modul 8,10 m² + extension module 4,80 m²

NOMENCLATURE EXTENSION - STÜCKLISTE ERWEITERUNG BILL OF MATERIALS EXTENSION

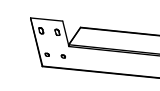
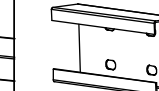
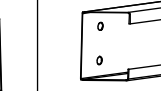



Colis - Paket - Parcel



1/2

PROFILÉS ALUMINIUM - ALUMINIUMPROFILE - ALUMINIUM PROFILES							
01011 x 2  L:1866 mm	15001 x 2  L:270 mm	23007 x 2  L:1866 mm	24001 x 3  L:1160 mm	25002 x 6  L:1214 mm	25017 x 6  L:1862 mm	38004 x 1  L:1866 mm	39001 x 2  L:634 mm
40001 x 2  L:602 mm	41001 x 4  L:518 mm	42001 x 2  L:602 mm	45001 x 1  L:400 mm	46001 x 2  L:250 mm	46002 x 2  L:200 mm	56003 x 2  L:1866 mm	57001 x 2  L:400 mm
PETITS COMPOSANTS - KLEINTEILE - SMALL COMPONENTS							
W002 x 2  M6 x 12 mm	W004 x 2  M6 x 8 mm	W006 x 56  M3.5 x 6 mm	W007 x 160  M6 x 14 mm	2004 x 2  Ø 6	2005 x 4  M6 x 12 mm	2006 x 37m  M6 x 12 mm	1001 x 106  M6
1002 x 94  M6 x 12 mm	1003 x 4  M6 x 8 mm	1005 x 12  M3.5 x 6 mm	1011 x 8  M6 x 14 mm	1015 x 4  Ø 6			
BASE ET VISSERIE - FUNDAMENTRAHMEN UND SCHRAUBEN - GREENHOUSE BASE AND SCREWS							
D012 x 2  1866x60x30 mm	D014 x 2  1866x60x30 mm	D015 x 2  1866x60x30 mm	W008 x 8  1866x60x30 mm	1008 x 8  Ø6	1009 x 8  M6 x 12 mm	1010 x 8  M6	

Colis - Paket - Parcel

2/2

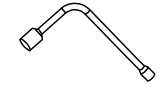
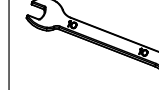
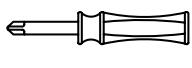
VERRES - GLÄSER - GLAZING							
1 x 12  610 x 610 mm	5 x 2  600 x 544 mm	16 x 4  610 x 549 mm	26 x 12  610 x 375 mm	PC18 x 6  610 x 610 mm			

OUTILS INCLUS VORHANDENE WERKZEUGE TOOLS INCLUDED		NON INCLUS NICHT VORHANDEN NOT INCLUDED	
 M6/10 mm	 M6/10 mm		 10 m

MONTAGE BASE - MONTAGE FUNDAMENTRAHMEN - BASE ASSEMBLING

Il est impératif que la base soit montée de niveau.



Es ist zwingend erforderlich, dass der Fundamentrahmen auf einer geraden Ebene montiert wird.

It is imperative that the greenhouse base is leveled.

Module de base
Basismodul
Basic module

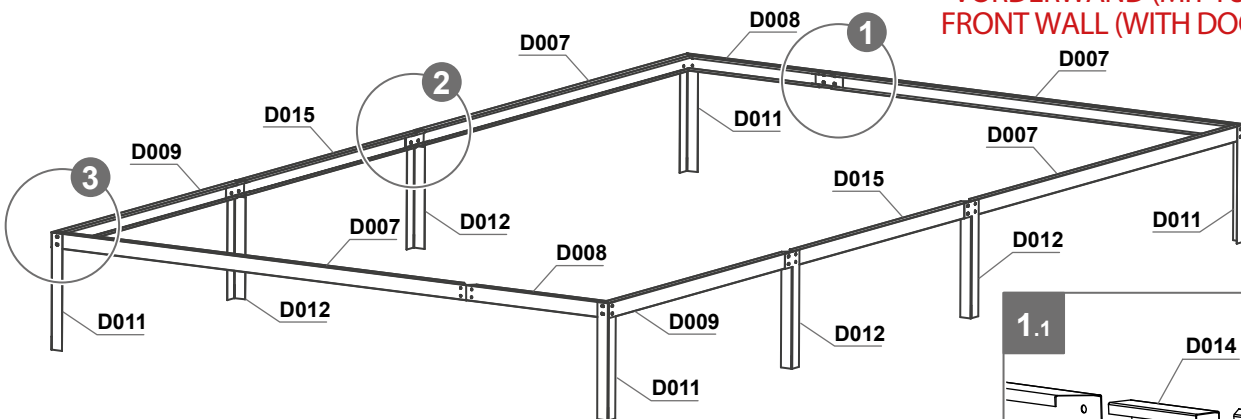
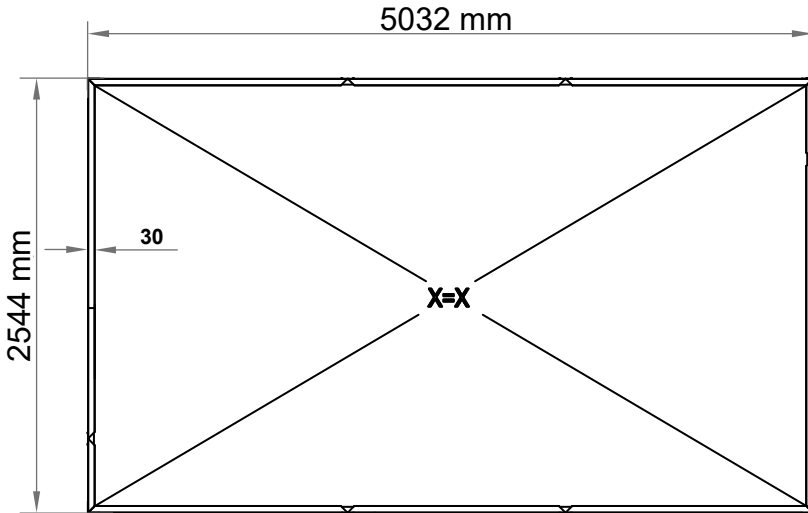

 FACE AVANT (AVEC PORTE)
VORDERWAND (MIT TÜR)
FRONT WALL (WITH DOOR)

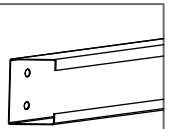

D007 x 4

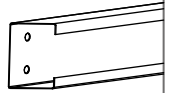

D008 x 2

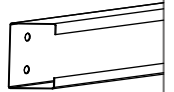

D009 x 2

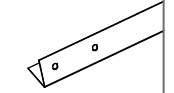

D011 x 4

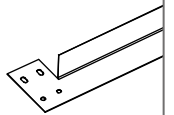

D012 x 2

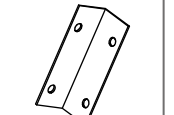

D013 x 4

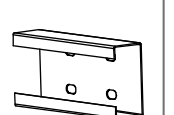

D014 x 4

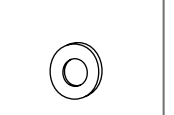

1008 x 32

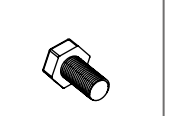

1009 x 32

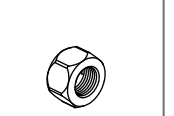

1010 x 32

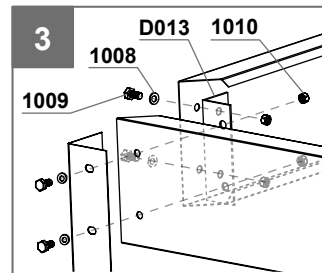
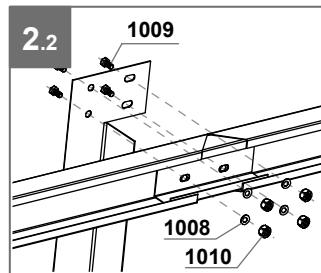
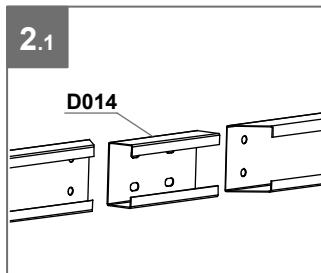
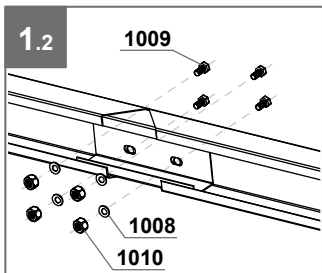

Module d'extension
Erweiterungsmodul
Extension module

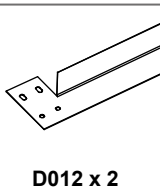

D012 x 2

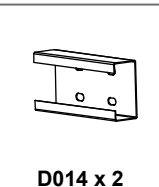

D014 x 2

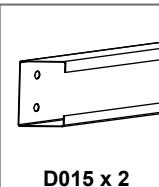

D015 x 2

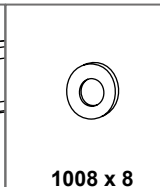

1008 x 8

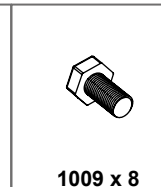

1009 x 8

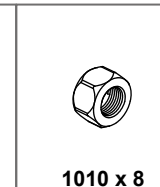

1010 x 8

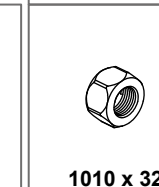

1010 x 32

FIXATION DE LA BASE AU SOL

FIXATION EN PLEINE TERRE

- Positionner la base à l'endroit voulu, de niveau sur un sol damé.
- Repérer et marquer l'emplacement des pattes de scellement suivant le schéma ci-dessous.
- Sous les quatre pieds marquer un carré de 300 x 300 mm et creuser sur une profondeur de 450 mm
- Placer la base, la mettre de niveau mais **ATTENTION**, ne pas remplir les trous avant le montage complet de la serre.

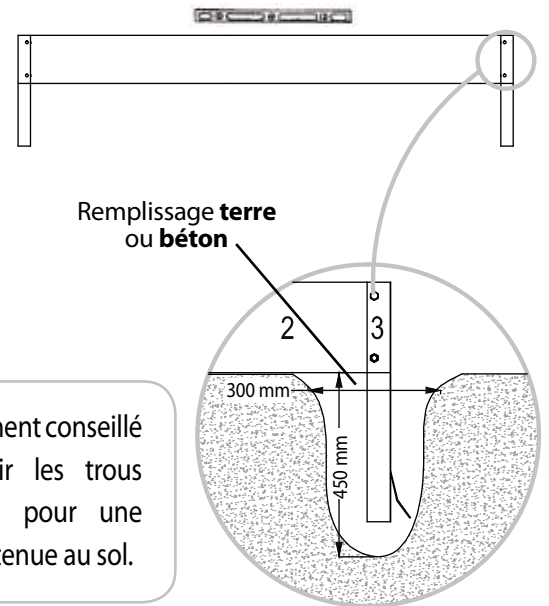
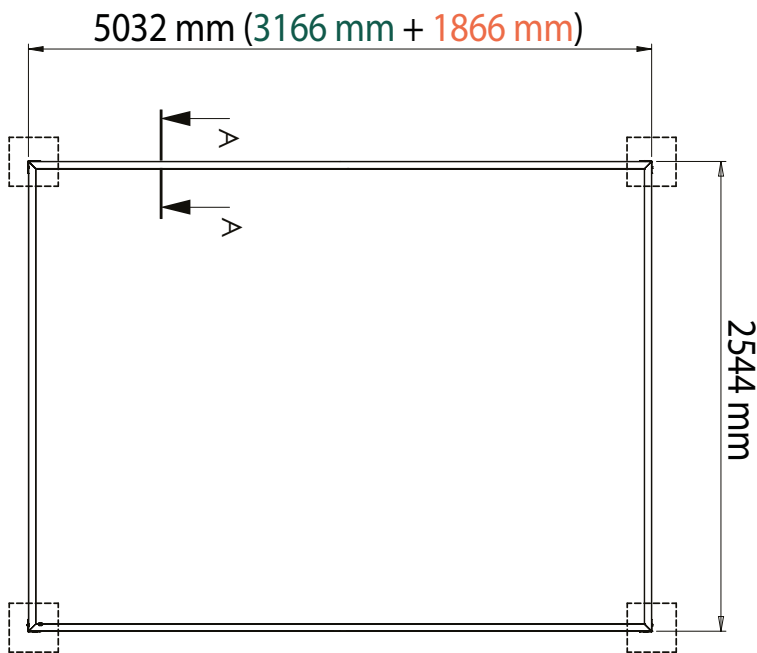

Il est vivement conseillé de remplir les trous de béton pour une meilleure tenue au sol.

OU

FIXATION SUR DALLE BÉTON

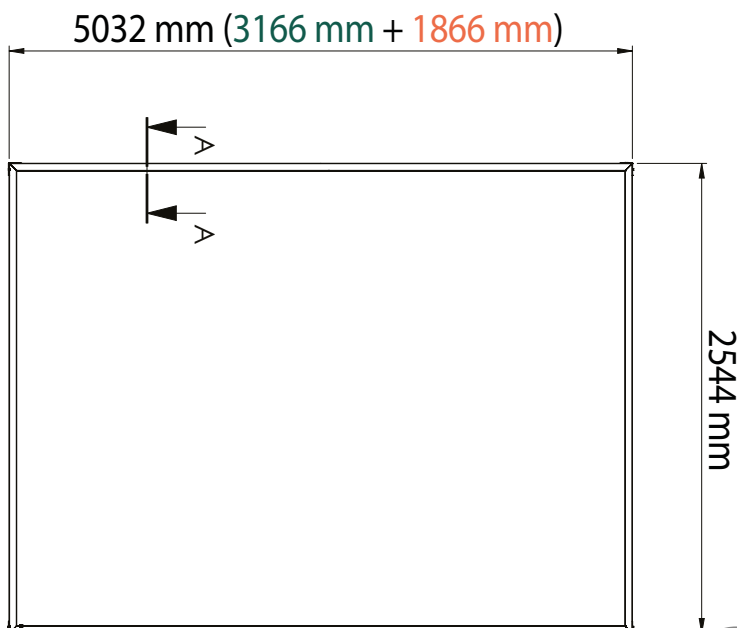

Détail A-A

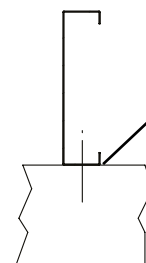

Fixation par chevilles à l'intérieur de la base



Visseries et chevilles de fixation non fournies

Il est laissé à votre libre choix et décision, l'utilisation des fixations adéquats selon les supports que vous décidez d'utiliser (pourtour bois, parpaings, plaques ciment, ...).



BEFESTIGUNG DES FUNDAMENTRAHMENS AM BODEN

BEFESTIGUNG AUF ERDBODEN (Punktfundament)

- Stellen Sie den Fundamentrahmen an der gewünschten Stelle, ebenerdig, auf einem gefüllten Boden.
- Orten und markieren Sie die Stelle der Ankerbeine gemäß dem untenstehenden Schema.
- Unter den vier Beinen ein 300 x 300 mm Quadrat kennzeichnen und 450 mm tief graben.
- Den Fundamentrahmen platzieren und nivellieren, aber **ACHTUNG**, die Löcher erst füllen, wenn das Gewächshaus komplett montiert ist.

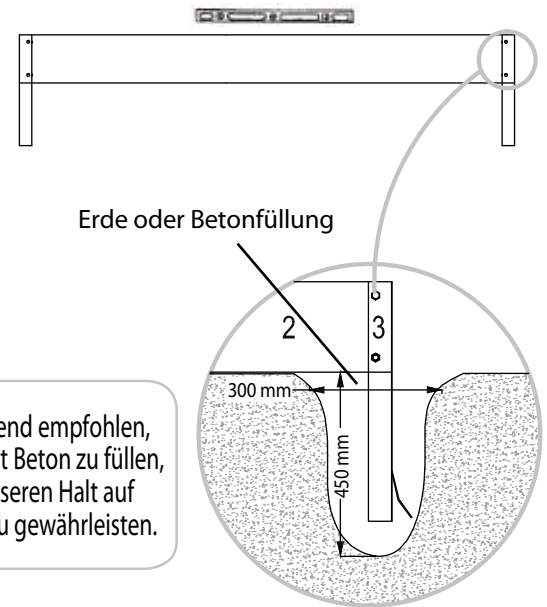
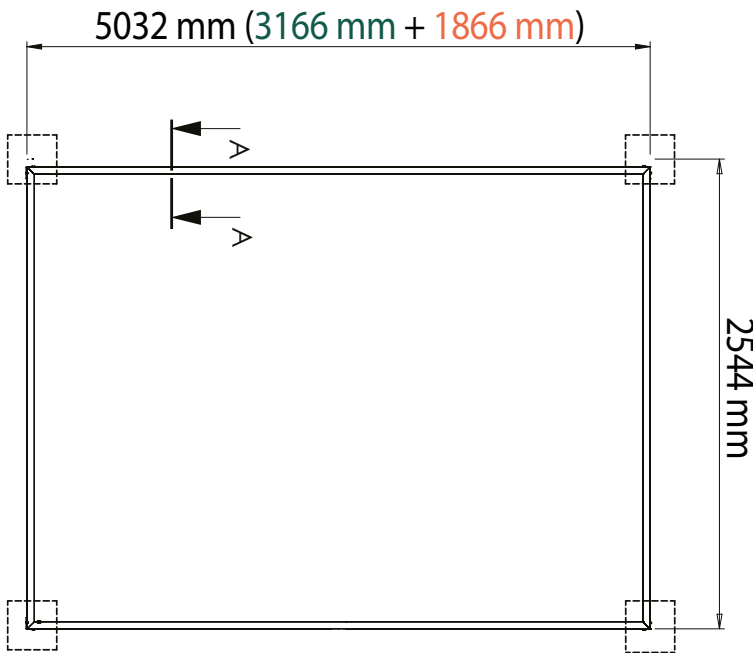

Es wird dringend empfohlen, die Löcher mit Beton zu füllen, um einen besseren Halt auf dem Boden zu gewährleisten.

ODER

BEFESTIGUNG AUF BETONDECKE (Streifenfundament)

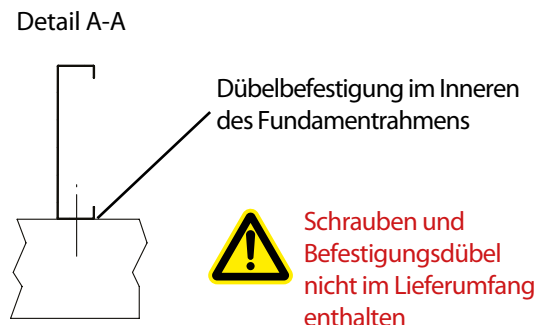
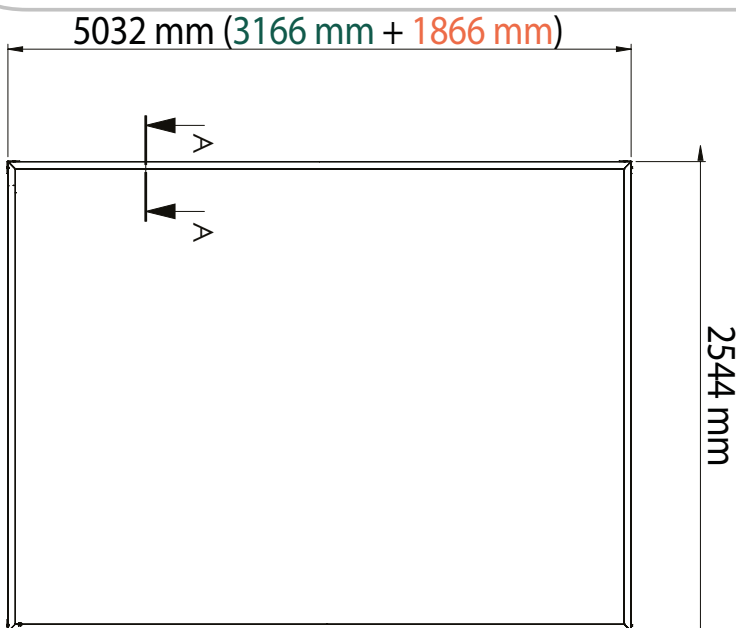

Es bleibt Ihrer freien Wahl und Entscheidung überlassen, die geeigneten Befestigungsmittel entsprechend der von Ihnen gewählten Träger (Holzumrandung, Bausteine, Zementplatten,...) zu verwenden.



FIXING THE GREENHOUSE BASE TO THE GROUND

FIXING ON SOIL

- Position the greenhouse base in the desired location at a level position on a filled floor.
- Locate and mark the location of the base legs as shown bellow.
- Under the four legs, mark a square of 300 x 300 mm and dig to a depth of 450 mm.
- Place the GREENHOUSE BASE, level it but CAUTION, do not fill the holes before the complete assembly of the greenhouse.

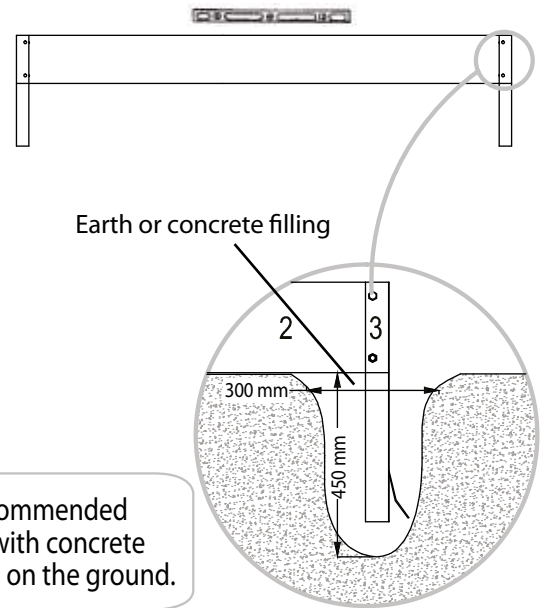
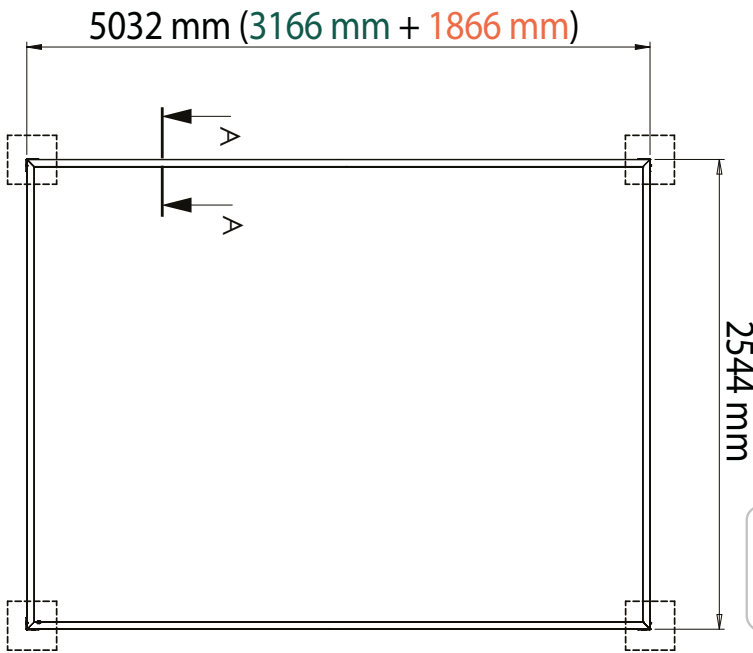

OR

FIXING ON CONCRETE SLAB

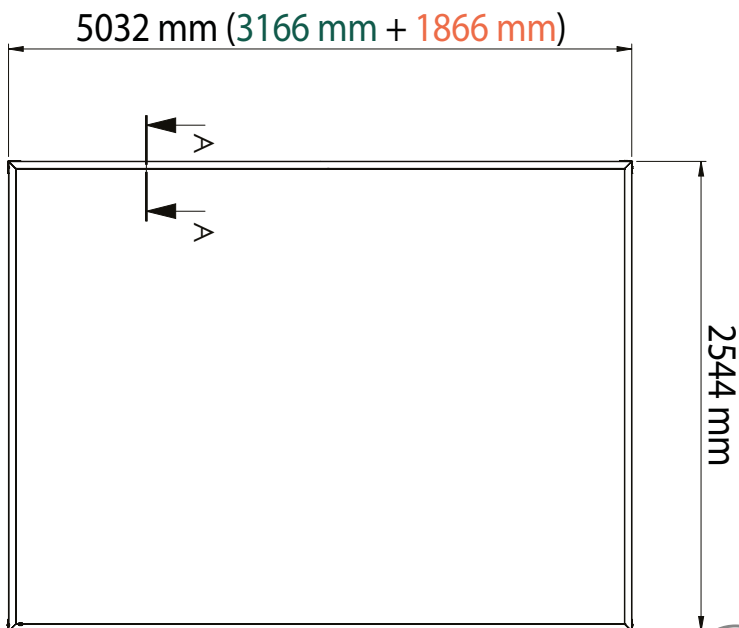

Detail A-A

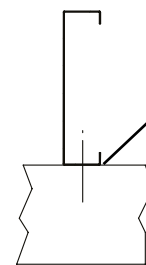

Rawplug fastening inside the greenhouse base



Screws and rawplugs not provided

It remains to your free choice and decision to use the suitable fastening means according to the supports you chose (wood border, building stones, cement plates etc.)

VIS 1002 & 1003 - SCHRAUBEN 1002 & 1003 - SCREWS 1002 & 1003

Mise en place des vis 1002 et 1003 dans les rainures en forme de T des profilés aluminium :
Entrez la tête de vis dans la rainure du profilé et tournez à 90° afin qu'elle ne puisse pas sortir du profilé. Assemblez la/les pièce(s) nécessaire(s) et serrez l'écrou.

Verwendung der Schrauben 1002 und 1003 in den T-förmigen Nuten der Aluminiumprofile :
Schraubenkopf in die Profilmutter stecken und diesen um 90° drehen, damit er nicht aus dem Profil herauskommt. Bauen Sie das/die benötigte(n) Einzelteil(e) zusammen und ziehen Sie die Schraubenmutter an.

Principle of use of screws 1002 and 1003 in the T-shaped grooves of the aluminium profiles :
Enter the screw head into the groove of the profile and turn the screw head at 90° so that it cannot exit the profile. Assemble the required part(s) and tighten the screw nut.

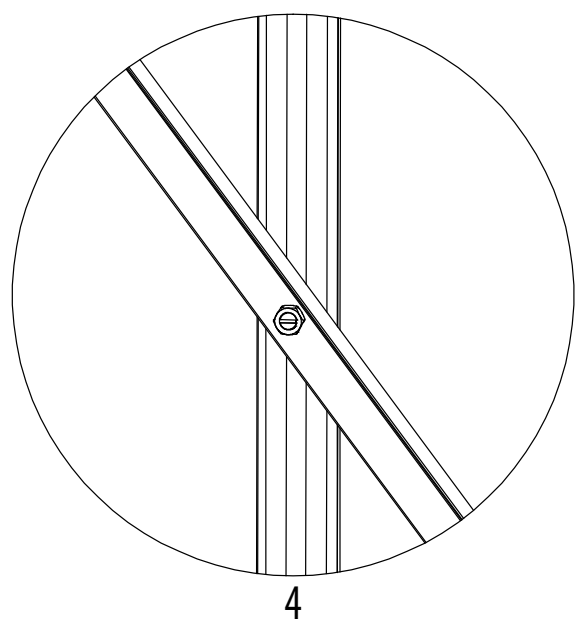
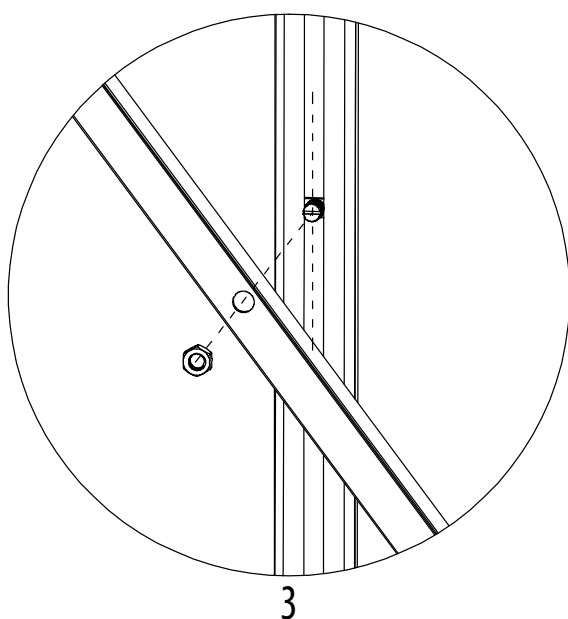
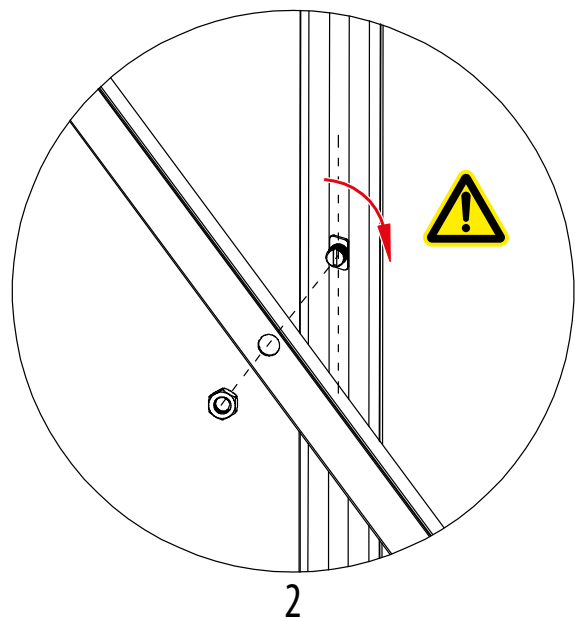
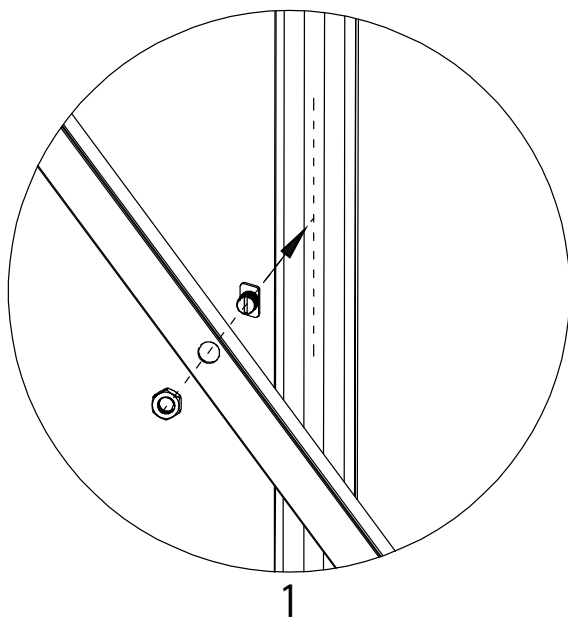

LONG-PAN (CÔTÉ) - SEITENWAND - SIDE WALL

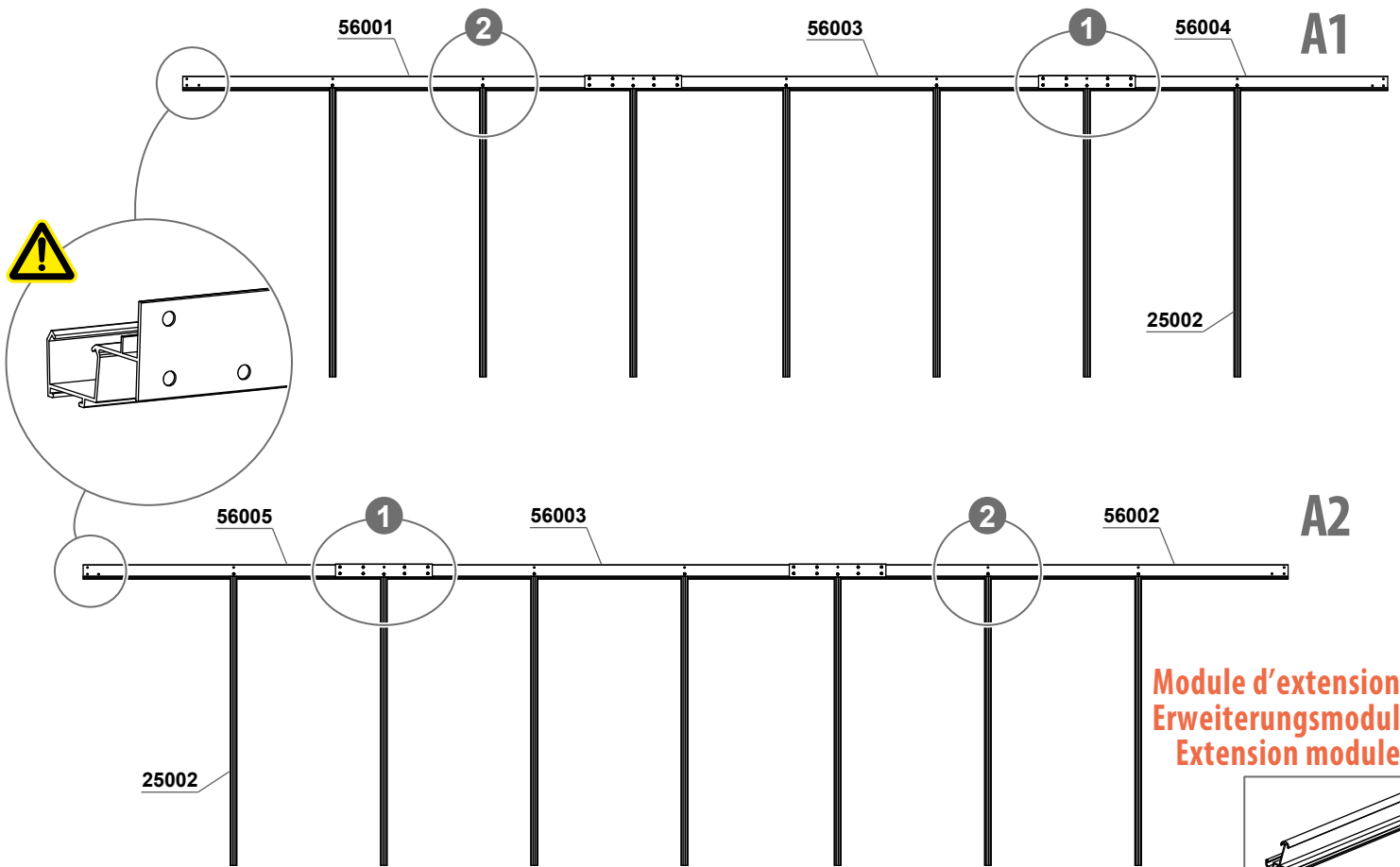

Module d'extension
Erweiterungsmodul
Extension module

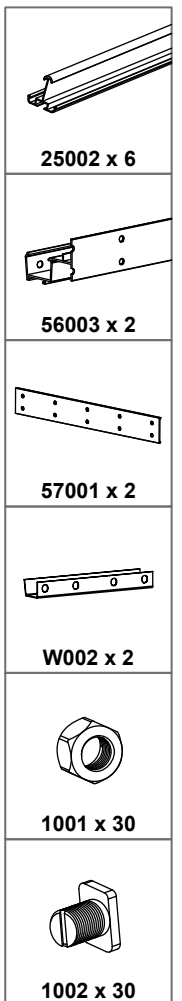
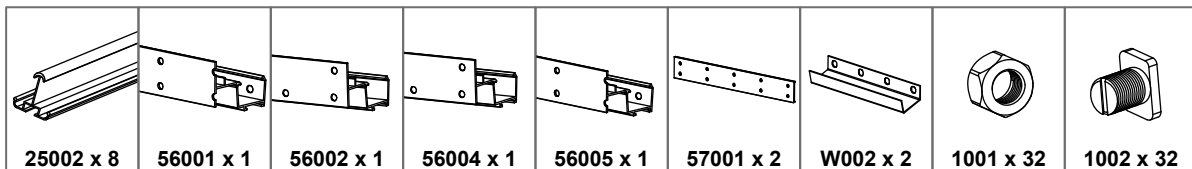
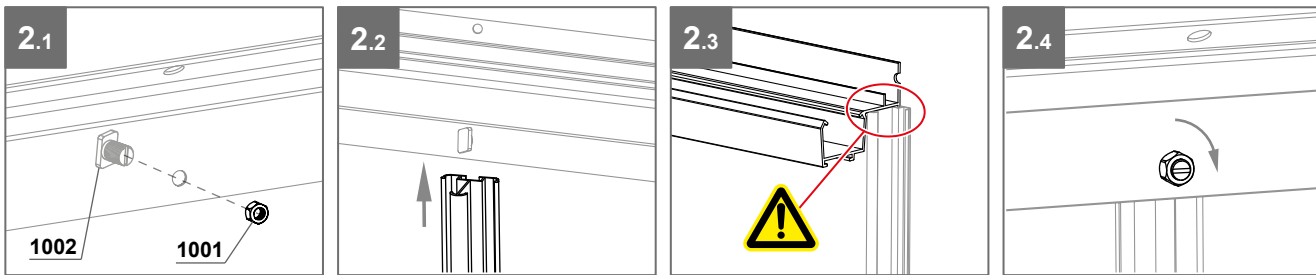
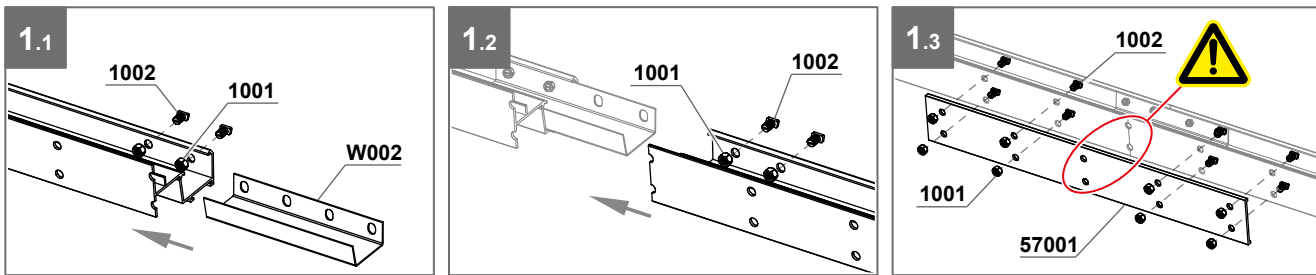

Module de base - Basismodul - Basic module

LONG-PAN (CÔTÉ) - SEITENWAND - SIDE WALL

Module d'extension
Erweiterungsmodul
Extension module

A1

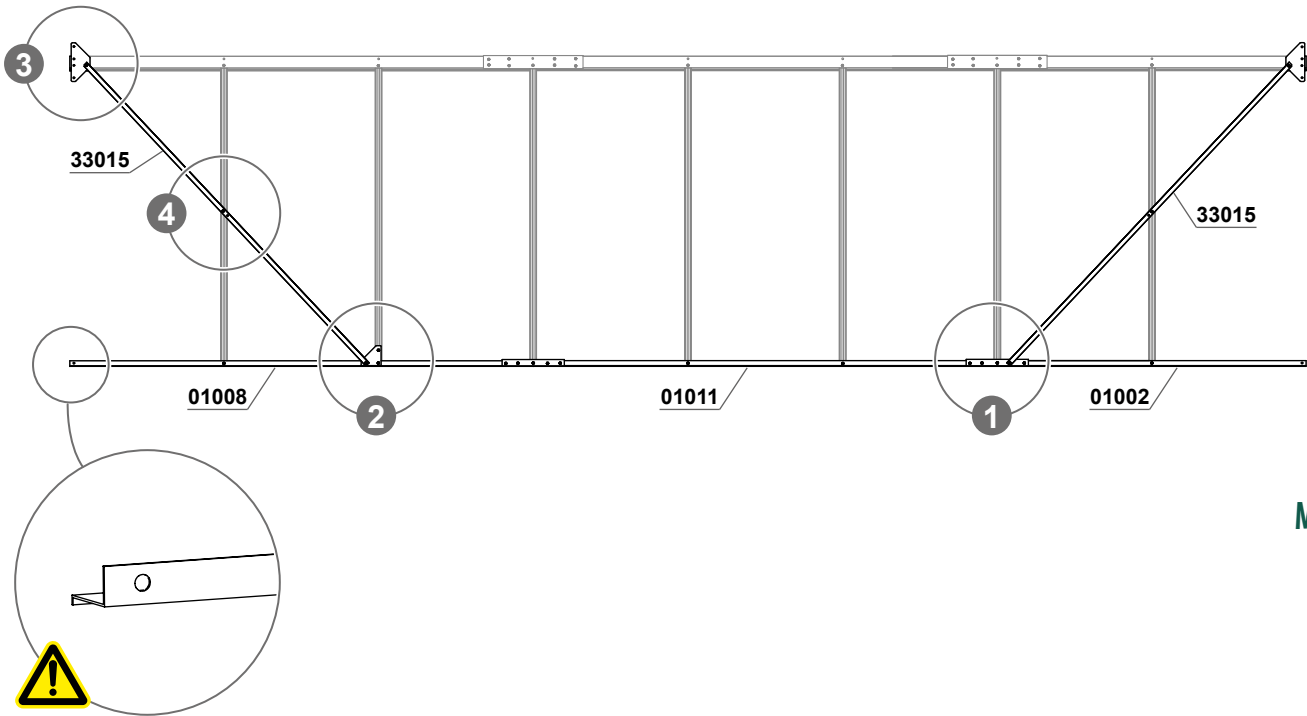

	01011 x 1
	46001 x 1
	1001 x 7
	1002 x 7

Module de base
Basismodul
Basic module

	01002 x 1
	01008 x 1
	33015 x 2
	46001 x 1
	W003 x 1
	W023 x 2
	1001 x 14
	1002 x 14

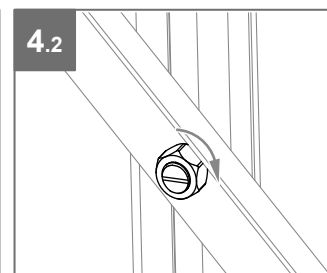
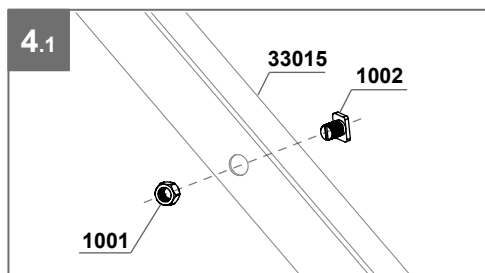
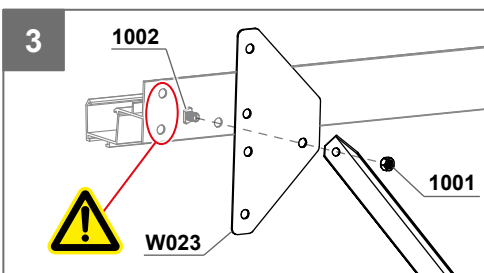
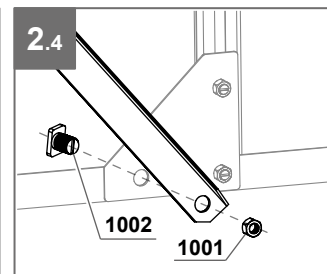
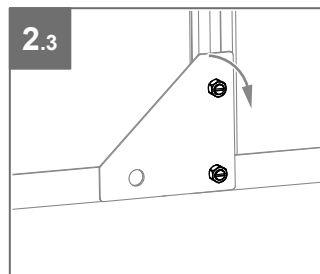
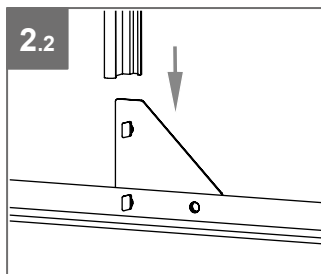
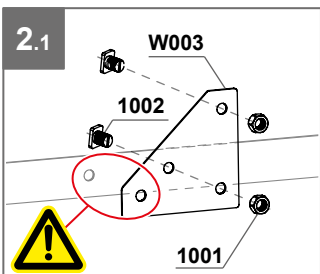
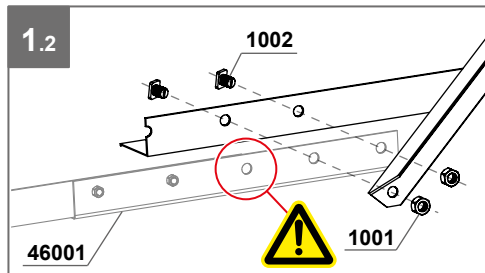
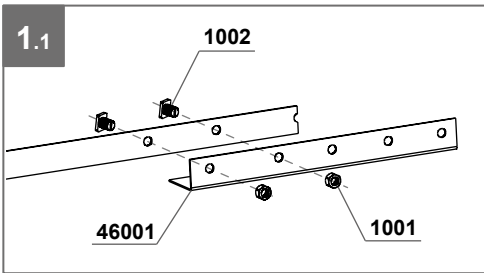



LONG-PAN (CÔTÉ) - SEITENWAND - SIDE WALL

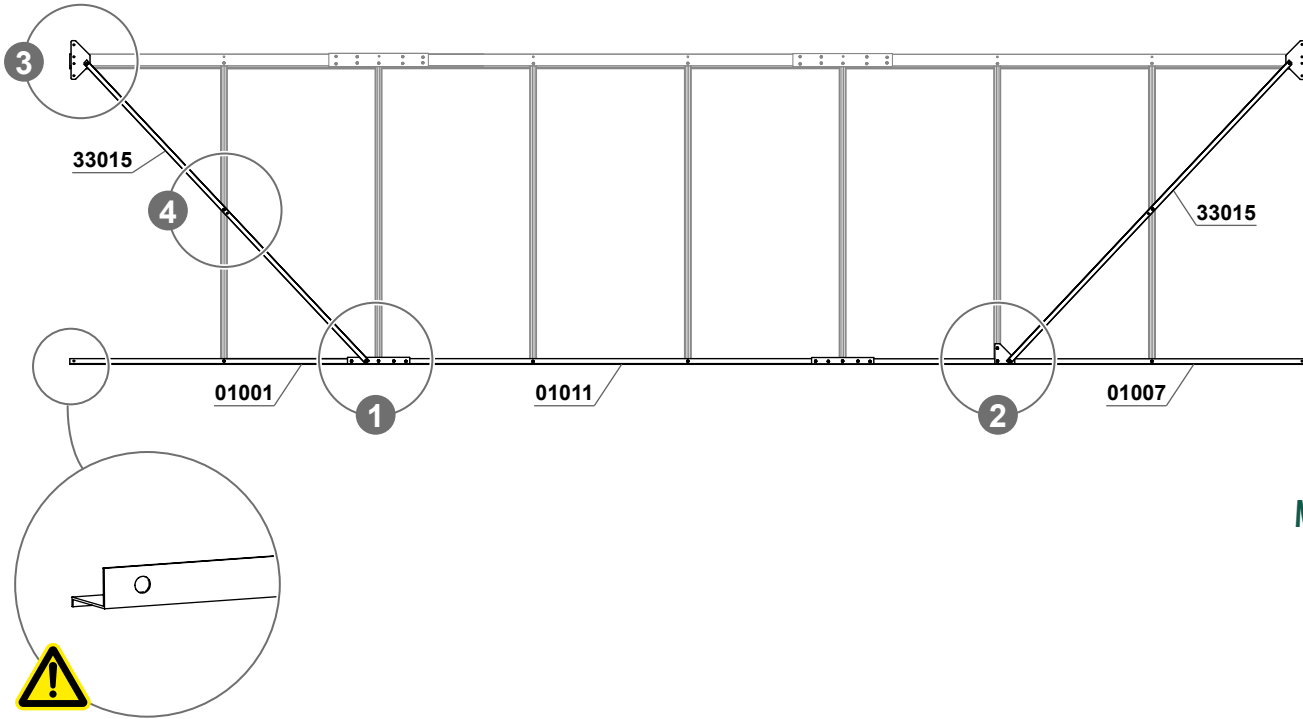

A2

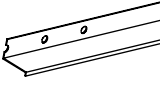
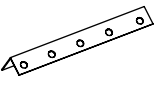
Module d'extension
Erweiterungsmodul
Extension module



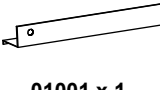
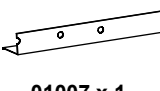
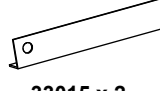
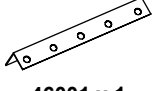

-  01011 x 1
-  46001 x 1
-  1001 x 7
-  1002 x 7

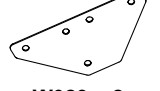
Module de base
Basismodul
Basic module

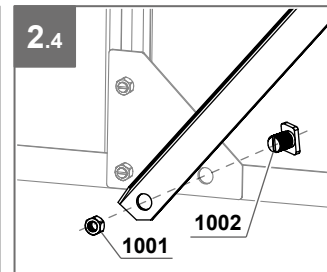
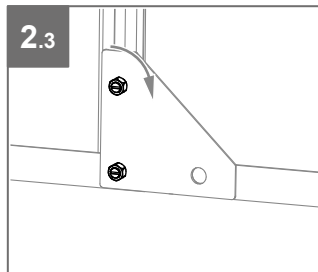
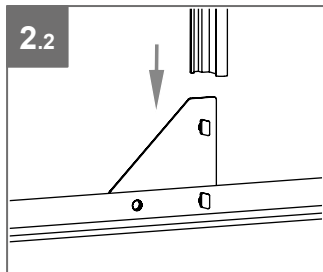
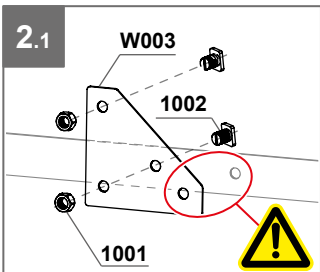
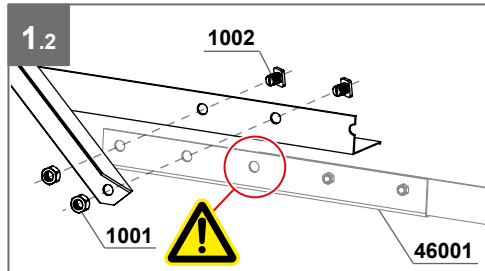
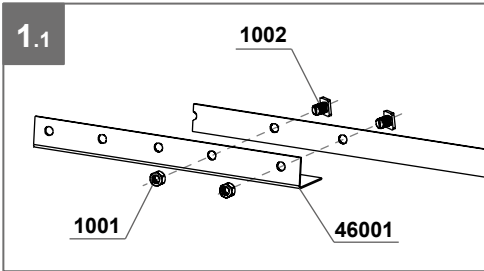
-  01001 x 1
-  01007 x 1
-  33015 x 2
-  46001 x 1
-  W003 x 1
-  W023 x 2



-  1001 x 14
-  1002 x 14

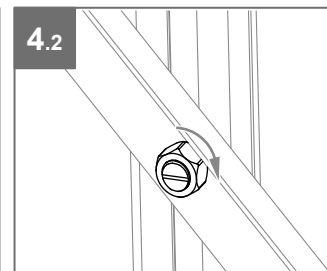
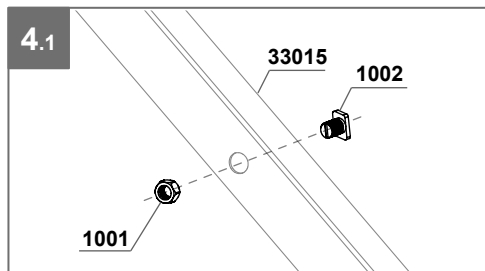
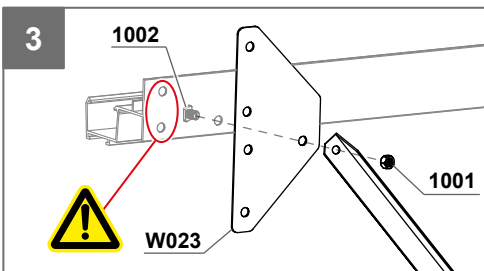

ÉTAPES SUIVANTES - NÄCHSTE SCHRITTE - NEXT STEPS

Montage de la face avant (avec porte) : pages 17-19
Montage der Vorderwand (mit Tür) : Seiten 17-19
Assembling the front wall (with door) : pages 17-19

Montage de la face arrière (sans porte) : pages 20-22
Montage der Rückwand (ohne Tür) : Seiten 20-22
Assembling the rear wall (without door) : pages 20-22

Montage de la porte : pages 23-24
Montage der Tür : Seiten 23-24
Assembling the door : pages 23-24

Montage de la lucarne : page 25
Montage des Fensters : Seite 25
Assembling the window : page 25

Puis revenir à la page 69
Dann zurück auf Seite 69
Then back to page 69

ASSEMBLAGE DES PAROIS - ZUSAMMENBAU DER WÄNDE

ASSEMBLY OF THE WALLS

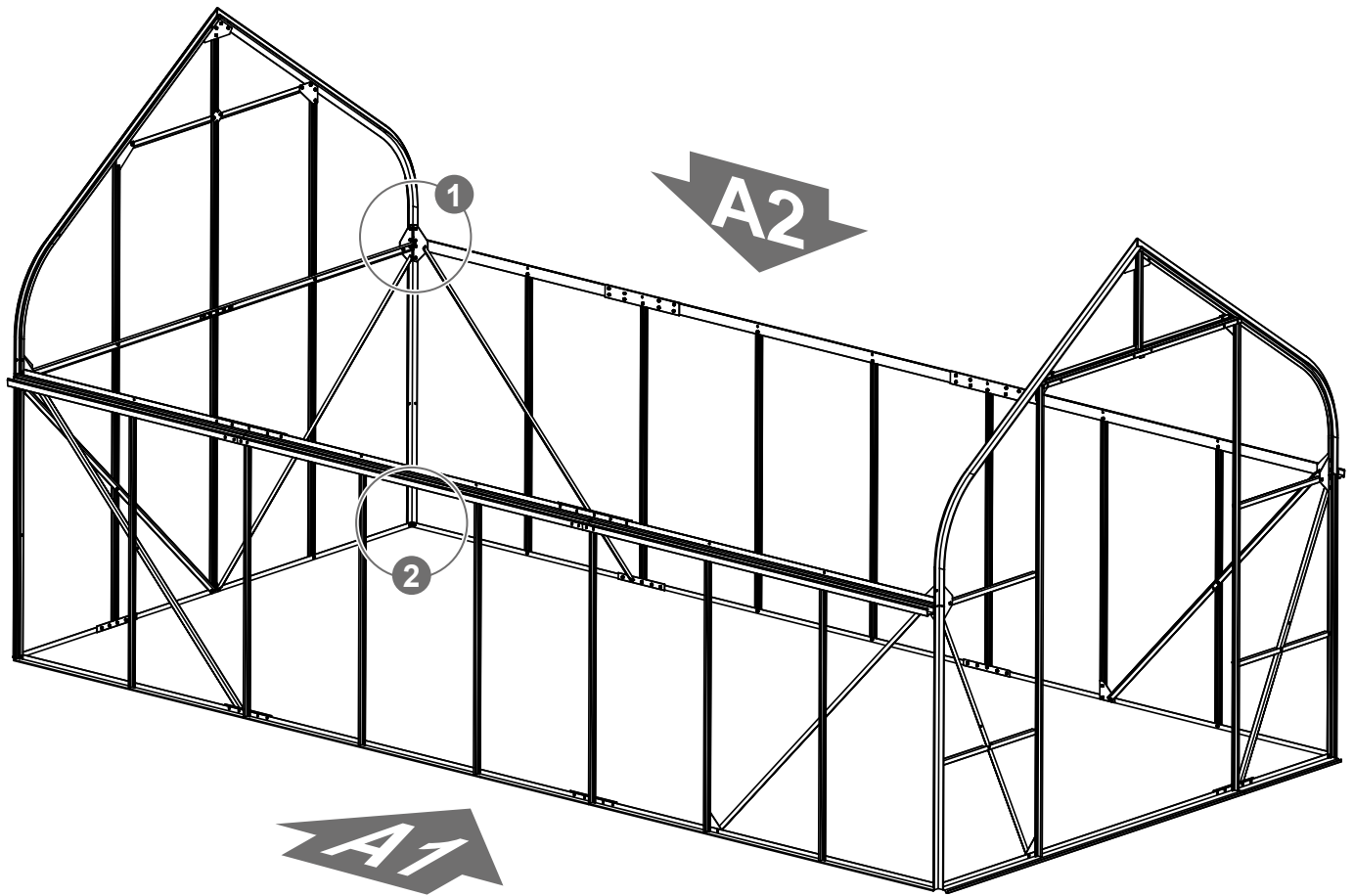

Module de base
Basismodul
Basic module

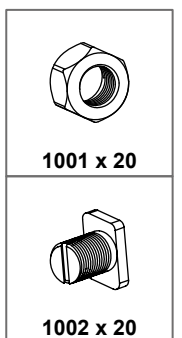
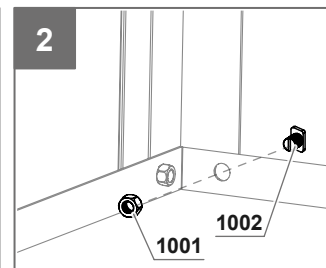
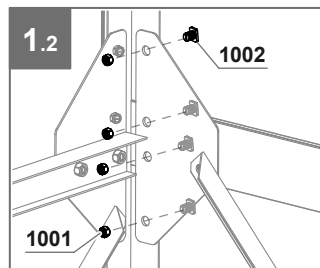
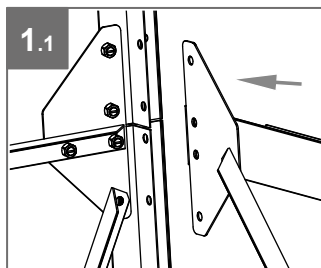
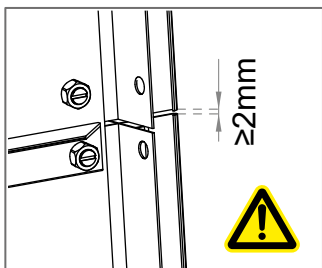

MONTAGE DES PROFILÉS DE TOITURE - MONTAGE DER DACHPROFILE ASSEMBLING THE ROOF PROFILES

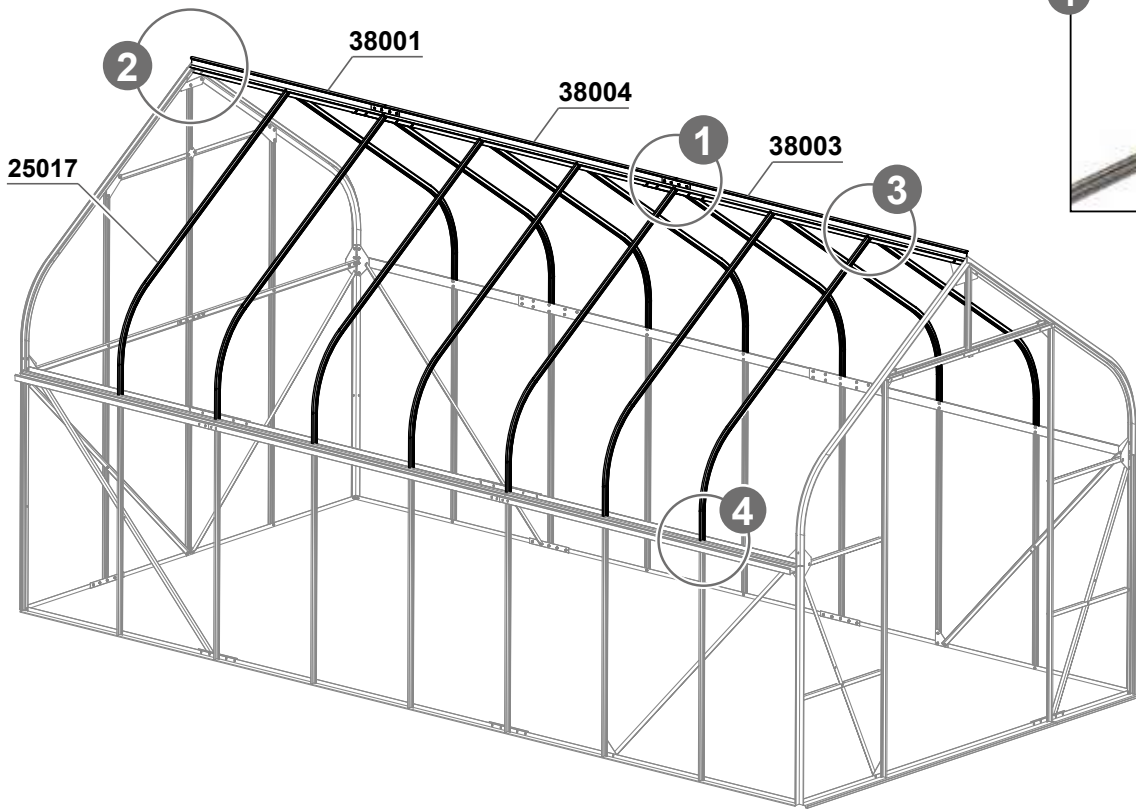

Module de base
Basismodul
Basic module

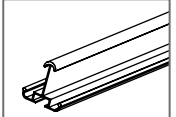

25017 x 8

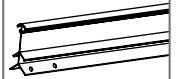

38001 x 1

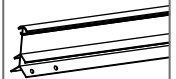

38003 x 1

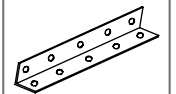

45001 x 1

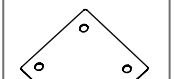

W003 x 4

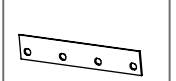

W004 x 2



1001 x 36

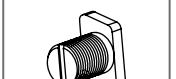

1002 x 28

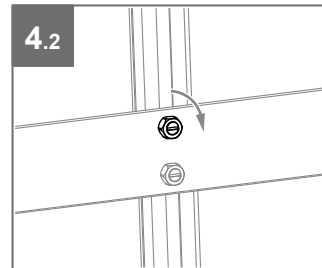
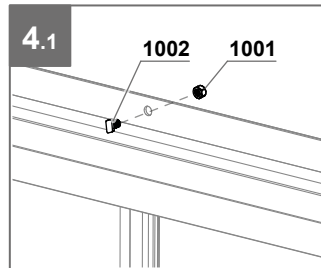
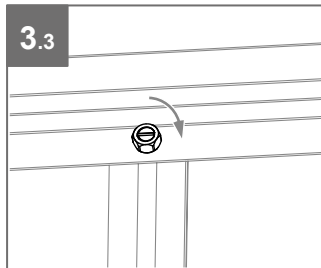
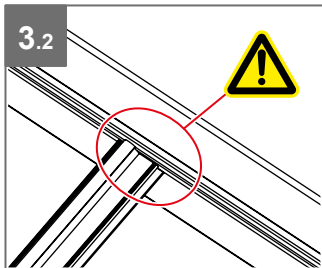
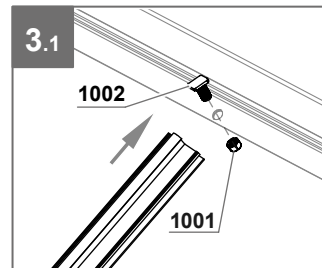
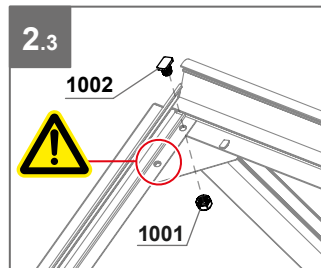
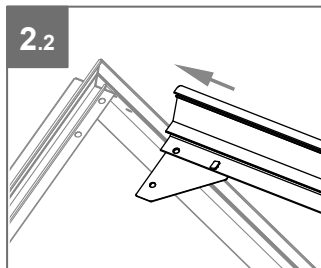
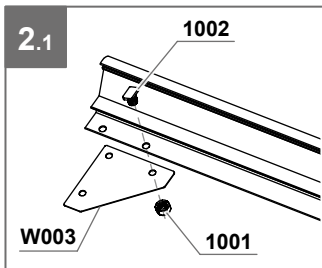
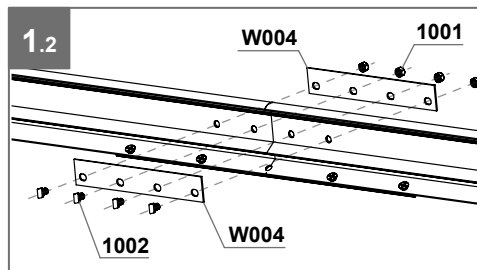
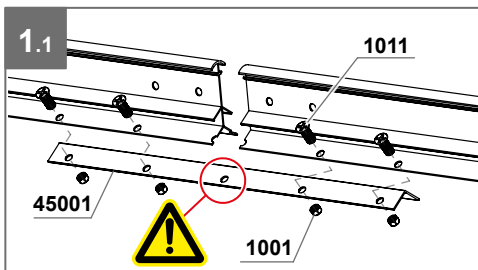

Module d'extension
Erweiterungsmodul
Extension module

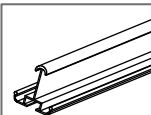

25017 x 6

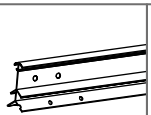

38004 x 1

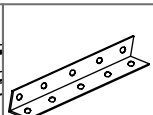

45001 x 1

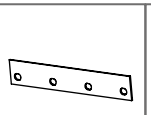

W004 x 2

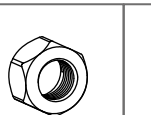

1001 x 24

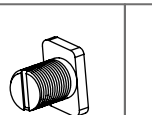

1002 x 16



1011 x 8



1011 x 8

MONTAGE DES PROFILÉS DE TOITURE - MONTAGE DER DACHPROFILE ASSEMBLING THE ROOF PROFILES

Module de base Basismodul Basic module

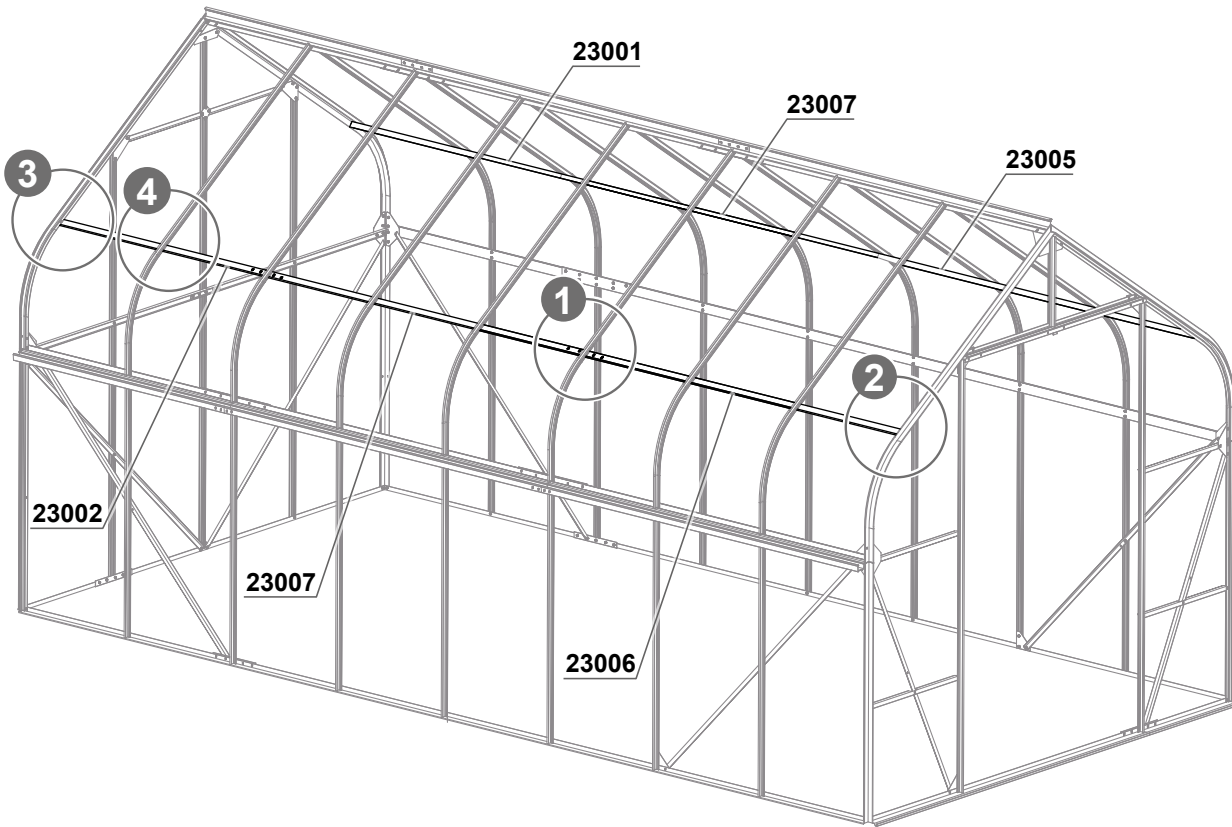

	23001 x 1
	23002 x 1
	23005 x 1
	23006 x 1
	46002 x 2
	1001 x 20
	1002 x 20

Module d'extension Erweiterungsmodul Extension module

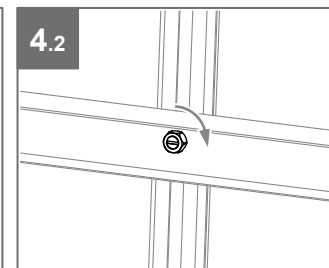
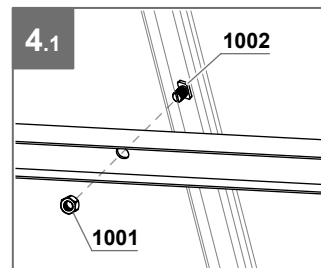
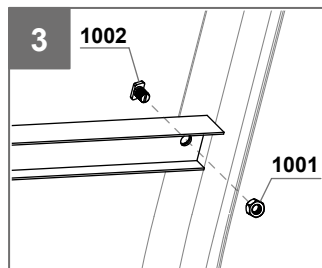
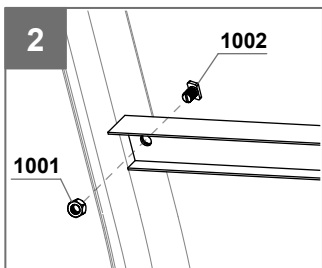
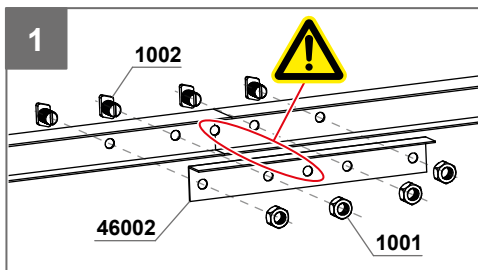

	23007 x 2
	46002 x 2
	1001 x 14
	1002 x 14

MONTAGE DES TENDEURS ET GOUSSETS SPANNVORRICHTUNG UND VERBINDER WIND BRACES AND GUSSETS

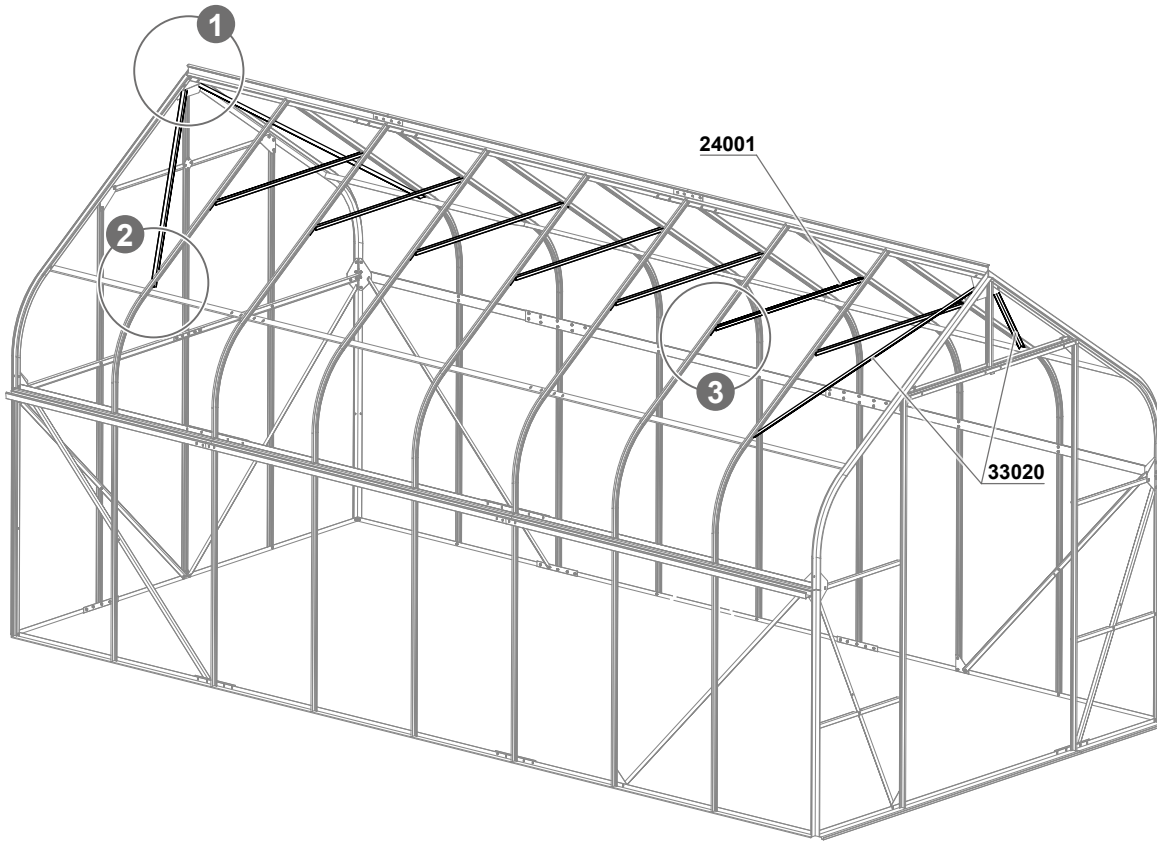

**Module d'extension
Erweiterungsmodul
Extension module**

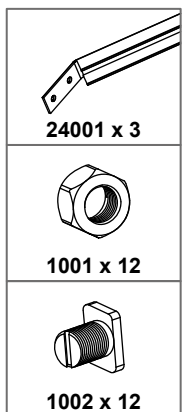

**Module de base
Basismodul
Basic module**

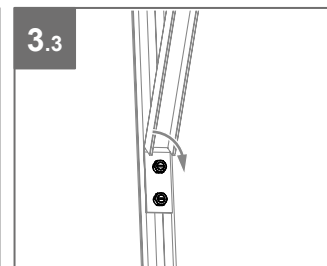
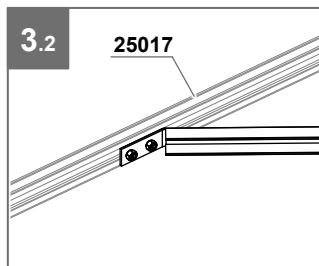
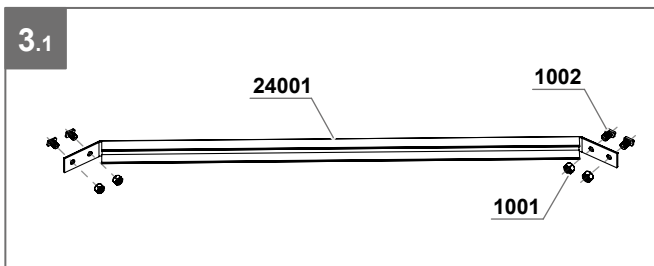
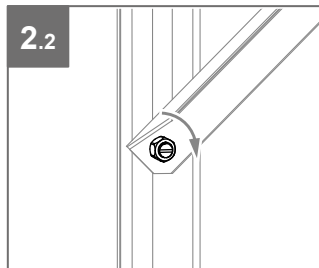
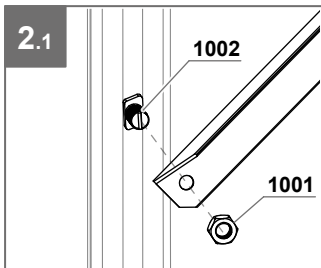
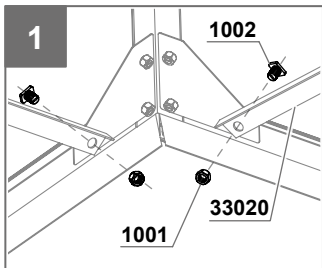
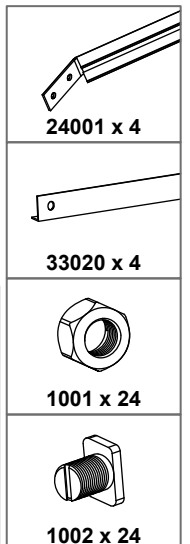

FIXATION DE LA SERRE SUR LA BASE BEFESTIGUNG DES GEWÄCHSHAUSES AM FUNDAMENTRAHMEN FASTENING THE GREENHOUSE BASE

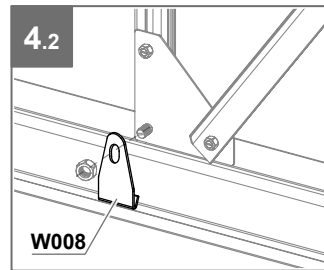
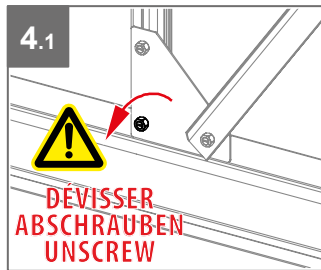
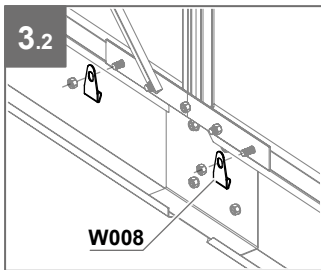
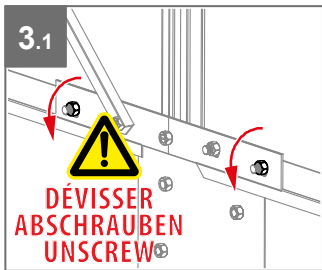
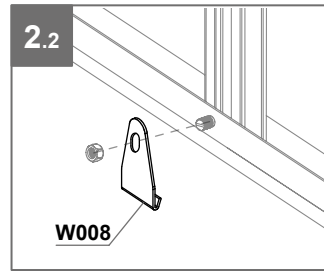
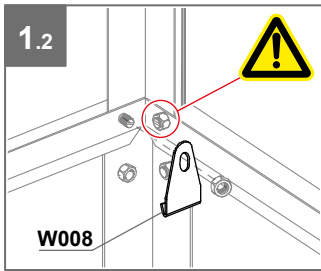
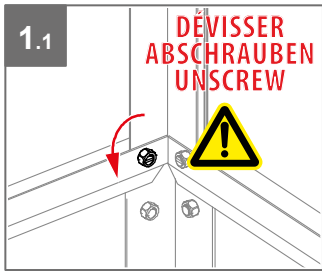
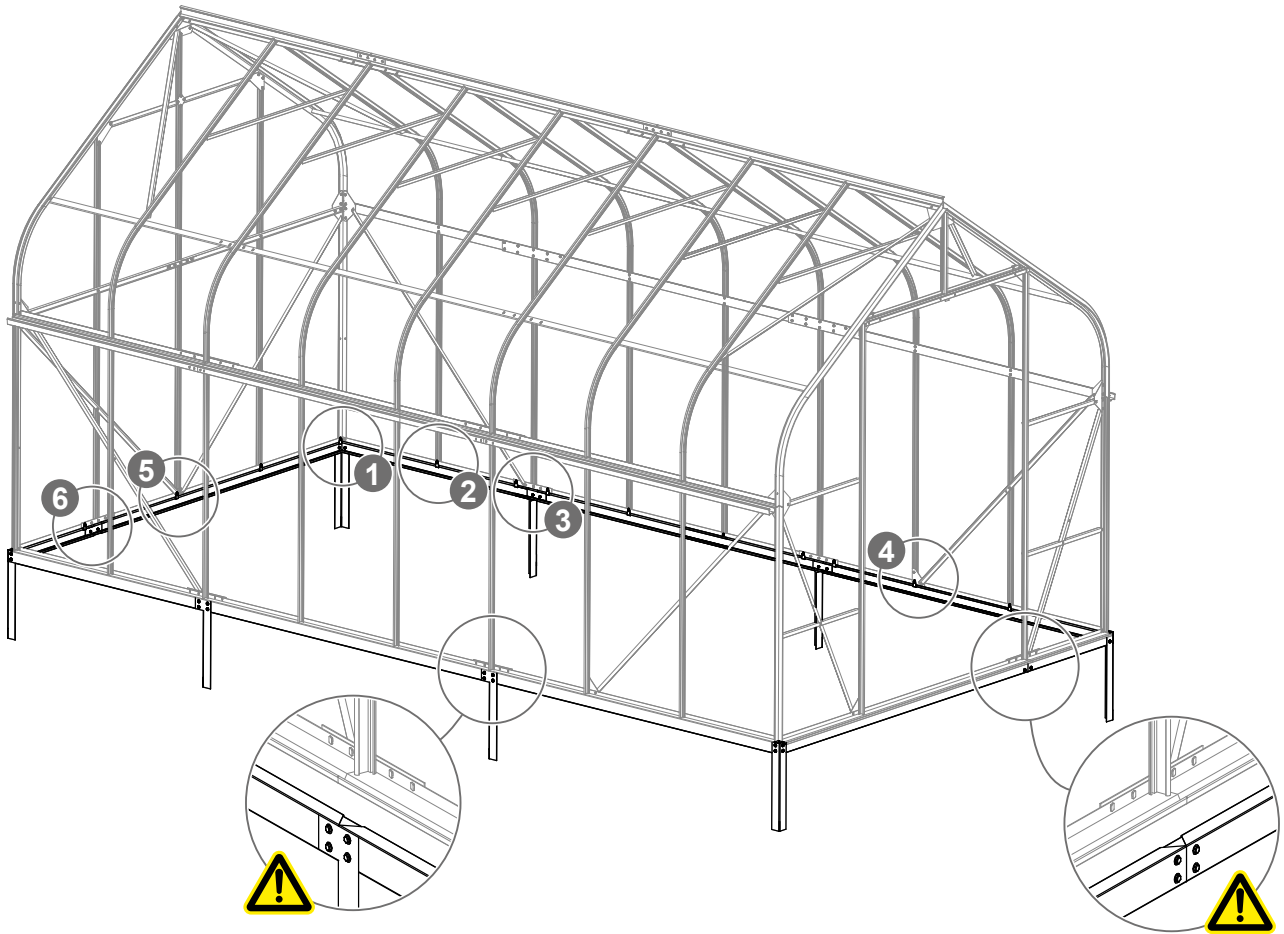

Module d'extension
Erweiterungsmodul
Extension module

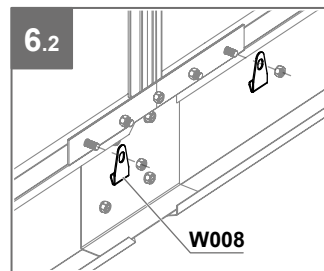
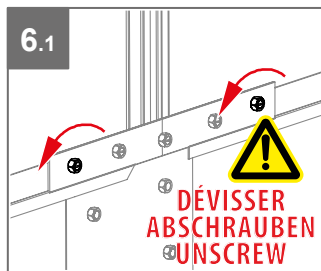
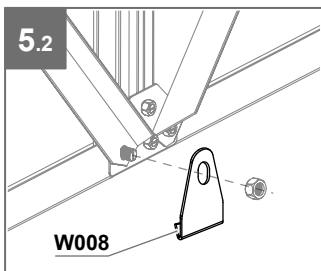
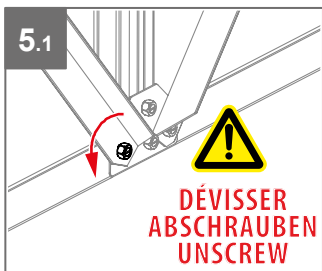
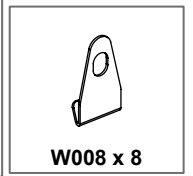

Module de base
Basismodul
Basic module

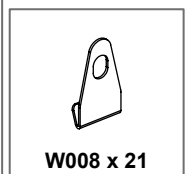

MONTAGE PORTE + RAIL MONTAGE TÜR + SCHIENE ASSEMBLING DOOR + RAIL



Recommandation : graissage régulier du rail
Empfehlung : Schiene regelmäßig schmieren
Recommendation : grease rail regularly

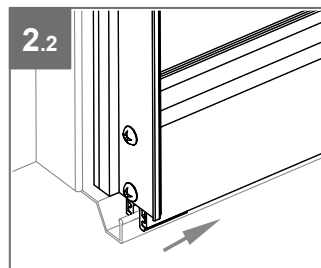
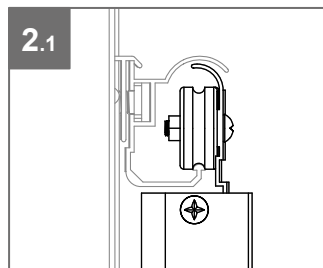
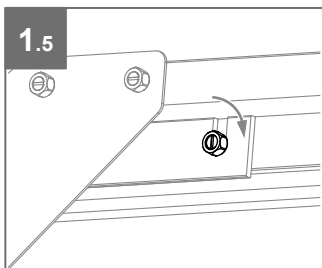
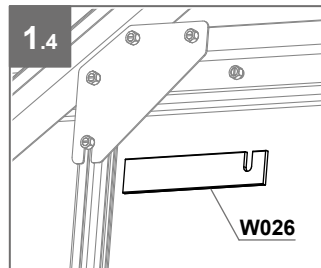
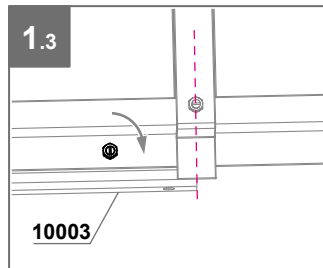
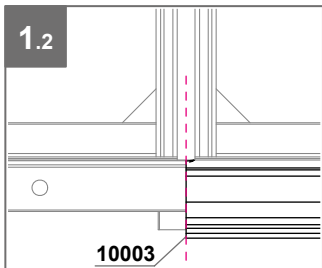
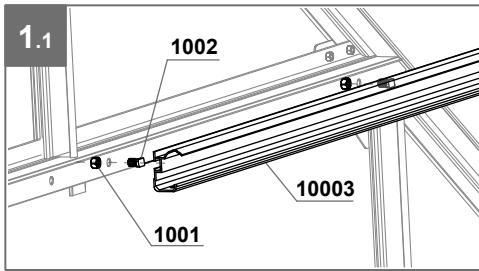
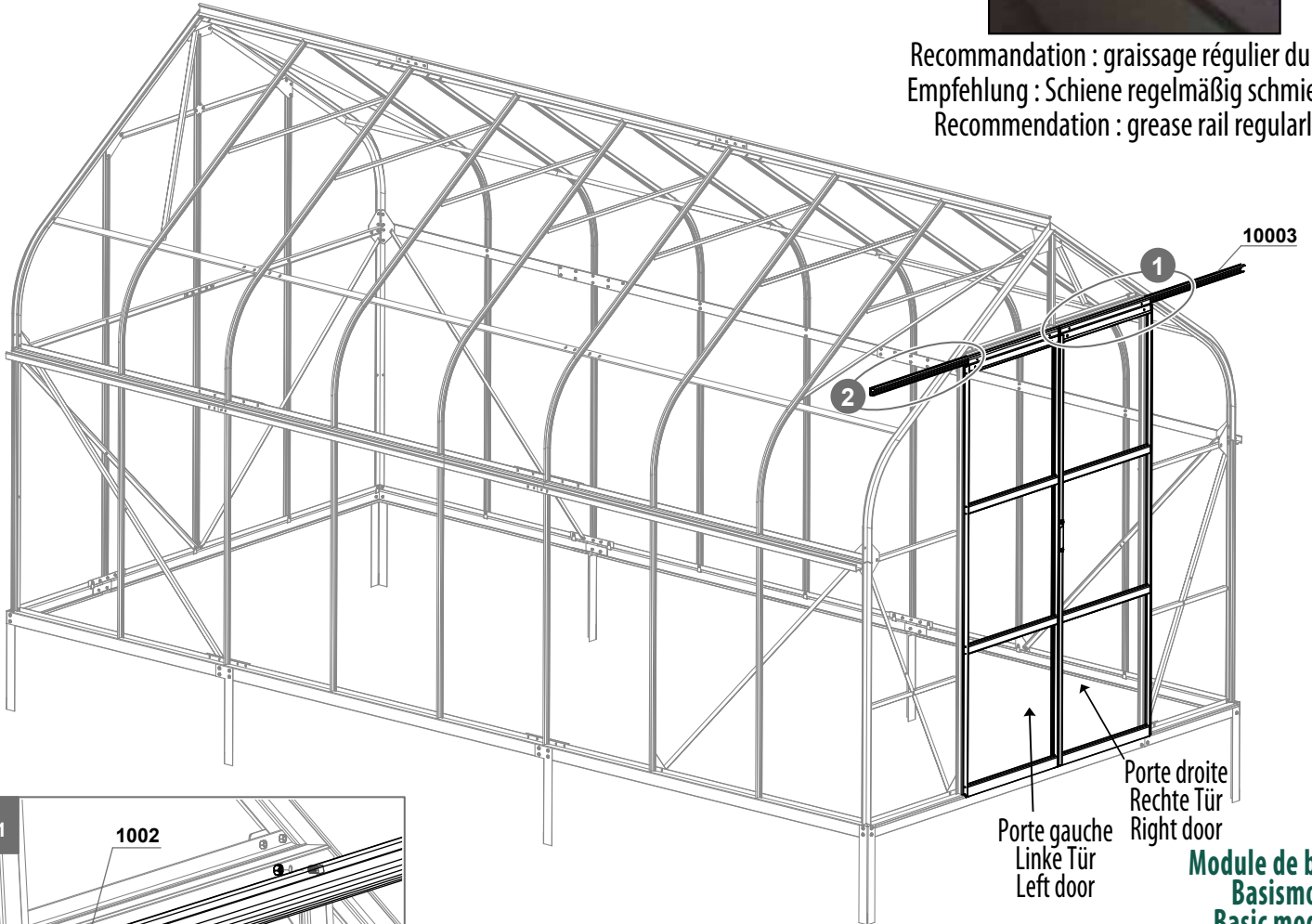

Module de base
Basismodul
Basic module



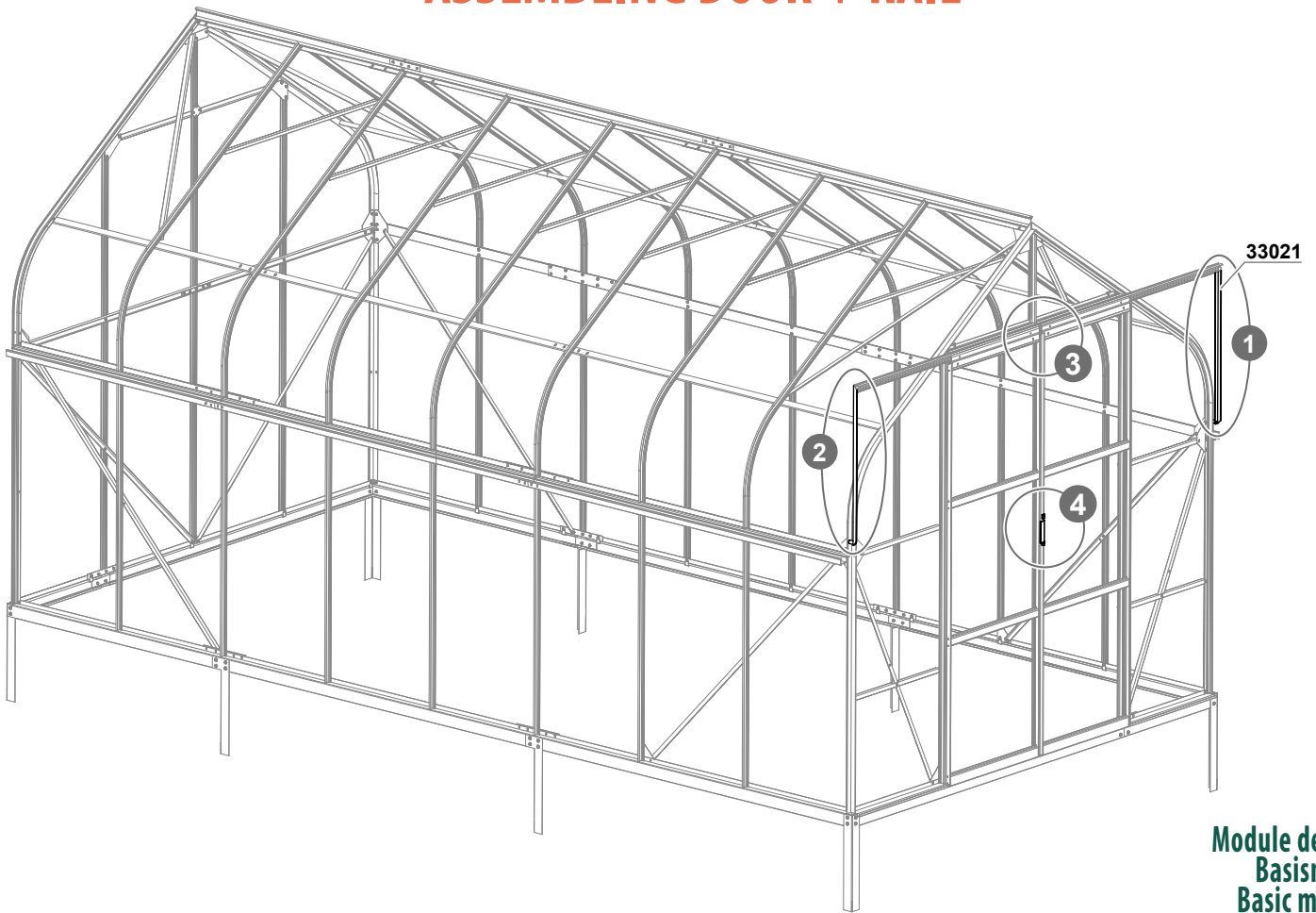

10003 x 2
1001 x 4
1002 x 4
W026 x 2

MONTAGE PORTE + RAIL MONTAGE TÜR + SCHIENE ASSEMBLING DOOR + RAIL

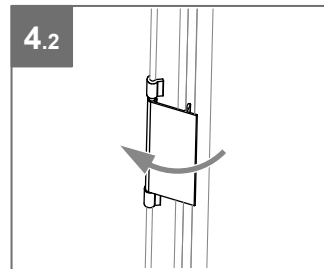
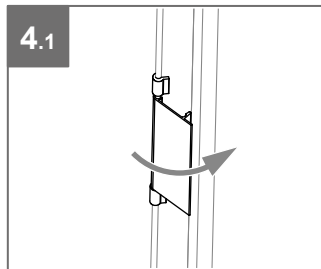
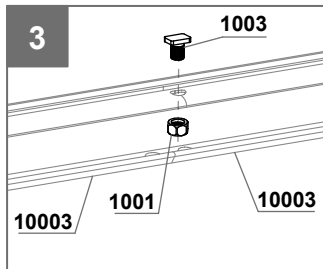
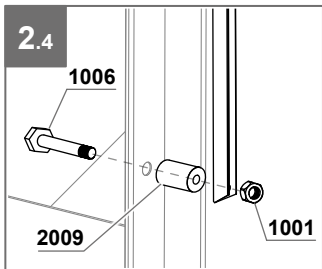
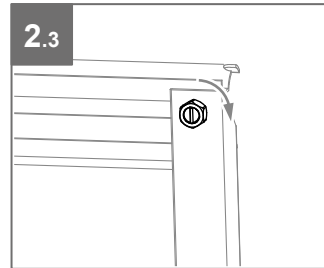
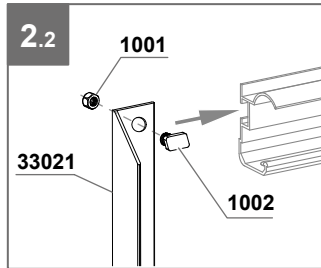
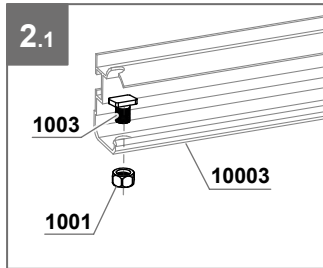
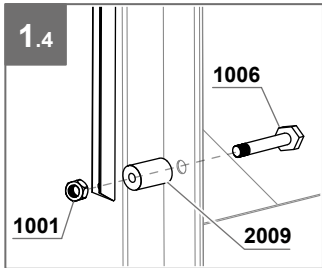
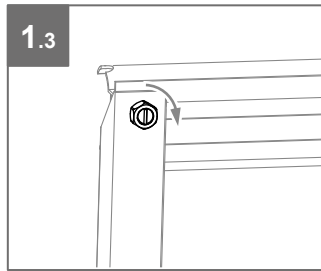
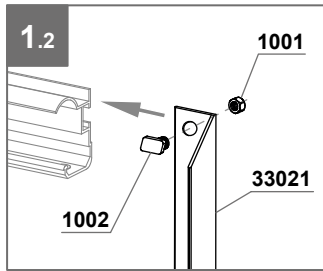
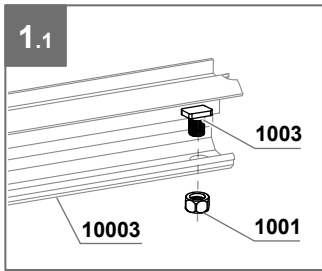

Module de base
Basismodul
Basic module

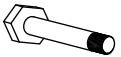

-  33021 x 2
-  1001 x 7
-  1002 x 2
1003 x 3
-  1006 x 2
-  2009 x 2

VITRAGE - VERGLASUNG - GLAZING

Nous vous conseillons d'installer les verres niveau par niveau (du bas vers le haut).



Wir empfehlen Ihnen, die Gläser Ebene für Ebene anzubringen (von unten nach oben).

We advise you to install the glazing level by level (from bottom to top).



Crochets de vitrage
Verglasungshaken
Glazing hooks



Clips de vitrage
Gewächshausklammern
Glazing clips

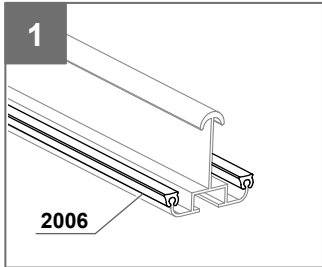

1 Pose du joint. Voir page 33. Puis continuez.
Dichtung anbringen (s. S. 33). Dann fortfahren.
Attach seal (s. p. 33). Then continue.

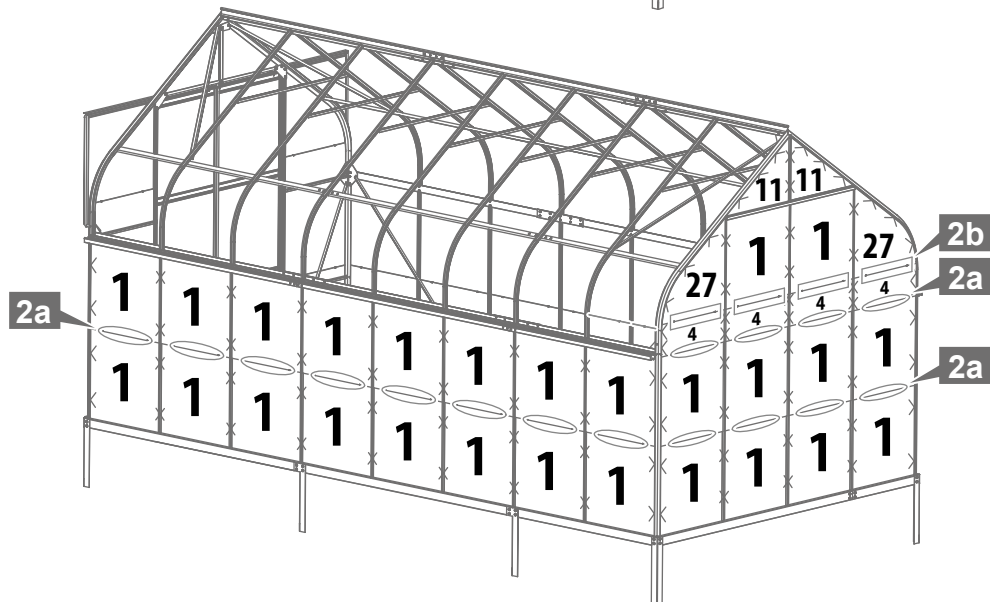
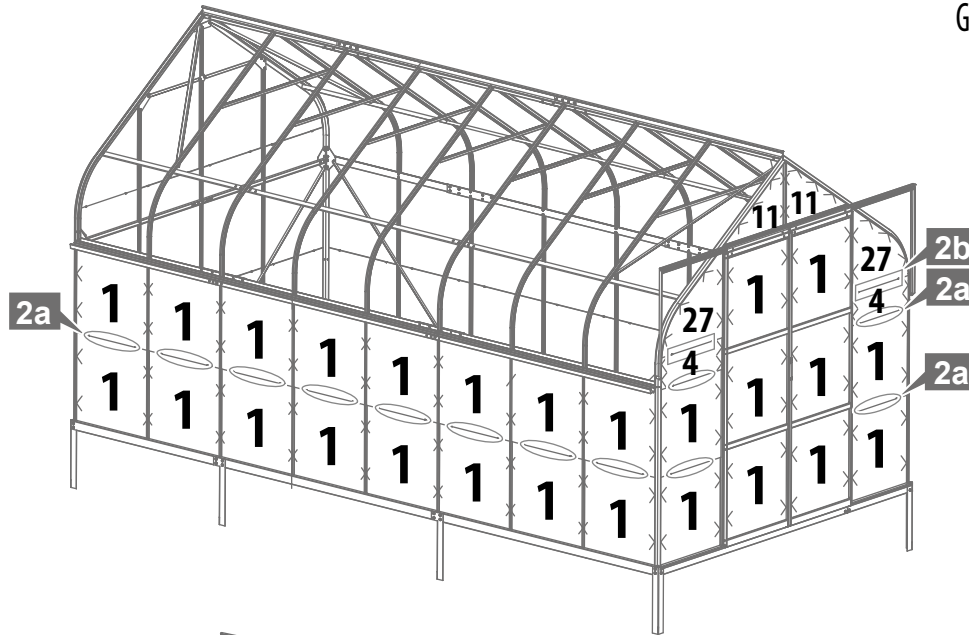
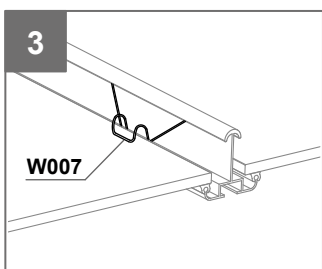
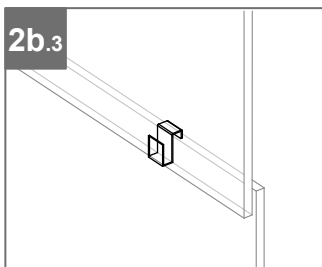
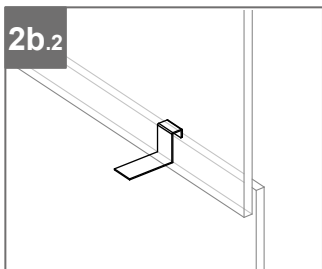
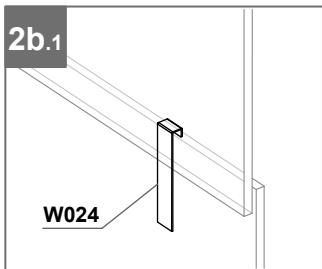
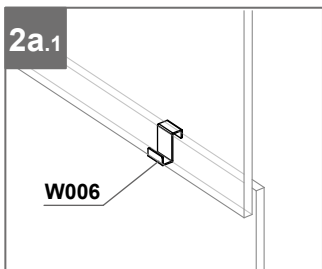

Module de base Basismodul Basic module

	610 x 610 1 x 40
	610 x 229 4 x 6
	610 x 434/8 11 x 4
	610 x 610 27 x 4
	2006 x 100m
	W006 x 44
	W007 x 224
	W024 x 12

Module d'extension Erweiterungsmodul Extension module

610 x 610 1 x 12	2006 x 37m	W006 x 12	W007 x 48	W024 x 12

VITRAGE + POSE LUCARNES VERGLASUNG + FENSTERN EINBAUEN GLAZING + INSTALLING WINDOWS



Lucarne - vue extérieure
Fenster - Außenansicht
Window - exterior view

Module de base Basismodul Basic module



1
Pose de la lucarne sur faîtière
par glissement.
Anbringung des Fensters auf
First durch Gleiten.
Installing the window on
roof ridge through sliding.

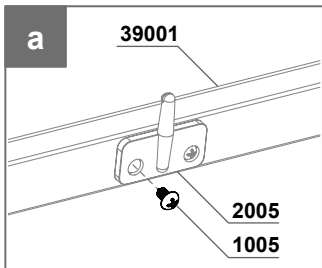
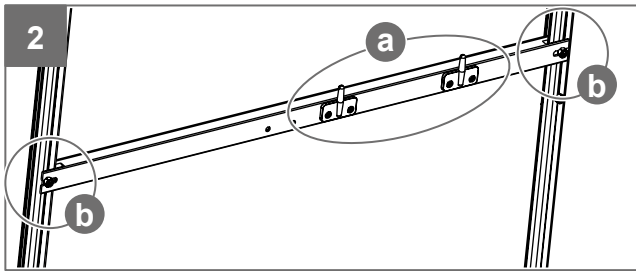
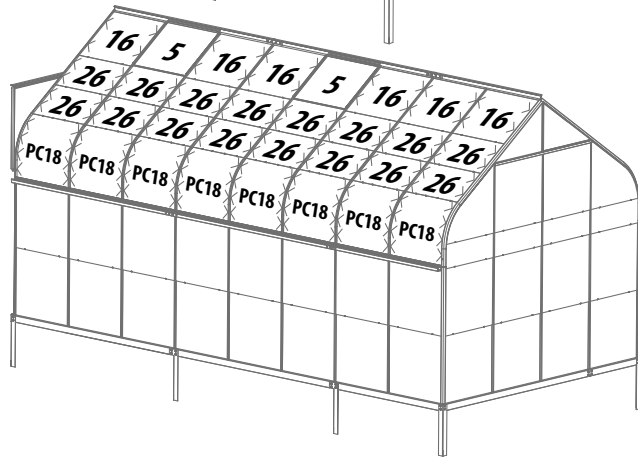
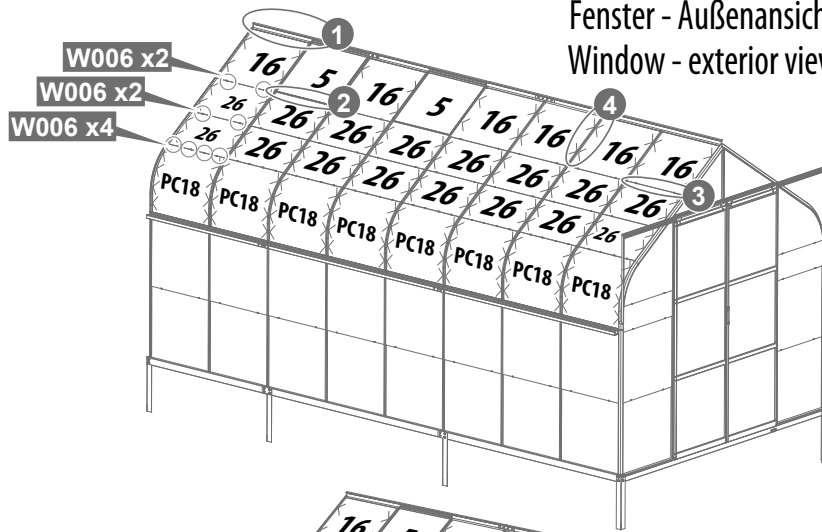

Dichtung schneiden um Einzelteil 39001 durchzulassen.
Cut the seal to let part 39001 through.

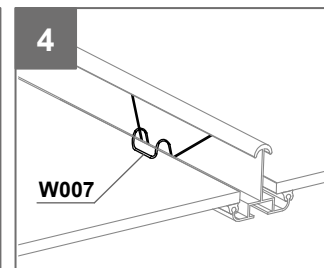
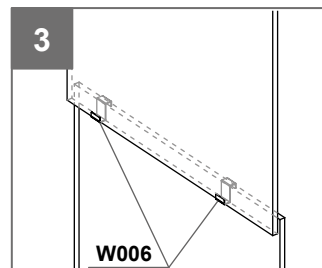
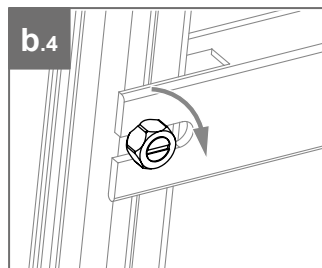
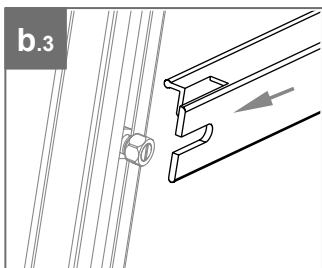
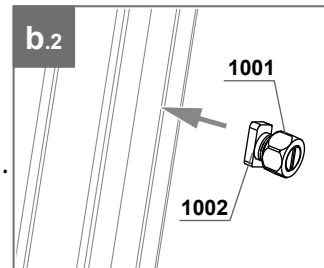

610 x 549



16 x 8

610 x 375



26 x 20

610 x 610



PC18 x 10

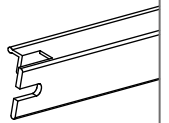

39001 x 2



1001 x 4



1002 x 4



1005 x 8



2005 x 4



W006 x 76



W007 x 192

Module d'extension - Erweiterungsmodul - Extension module

610 x 549



16 x 4

610 x 375



26 x 12

610 x 610



PC18 x 6

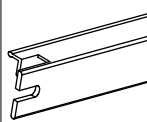

39001 x 2



1001 x 4



1002 x 4



1005 x 8



2005 x 4



W006 x 44



W007 x 112

MONTAGE DES PIÈCES PLASTIQUES

MONTAGE DER KUNSTSTOFFTEILE

INSTALLING THE PLASTIC PARTS



Détail embout de faîtière (pièce 2010)
 Abdeckung der Firstspitze (Einzelteil 2010)
 Roof ridge end cover (part 2010)

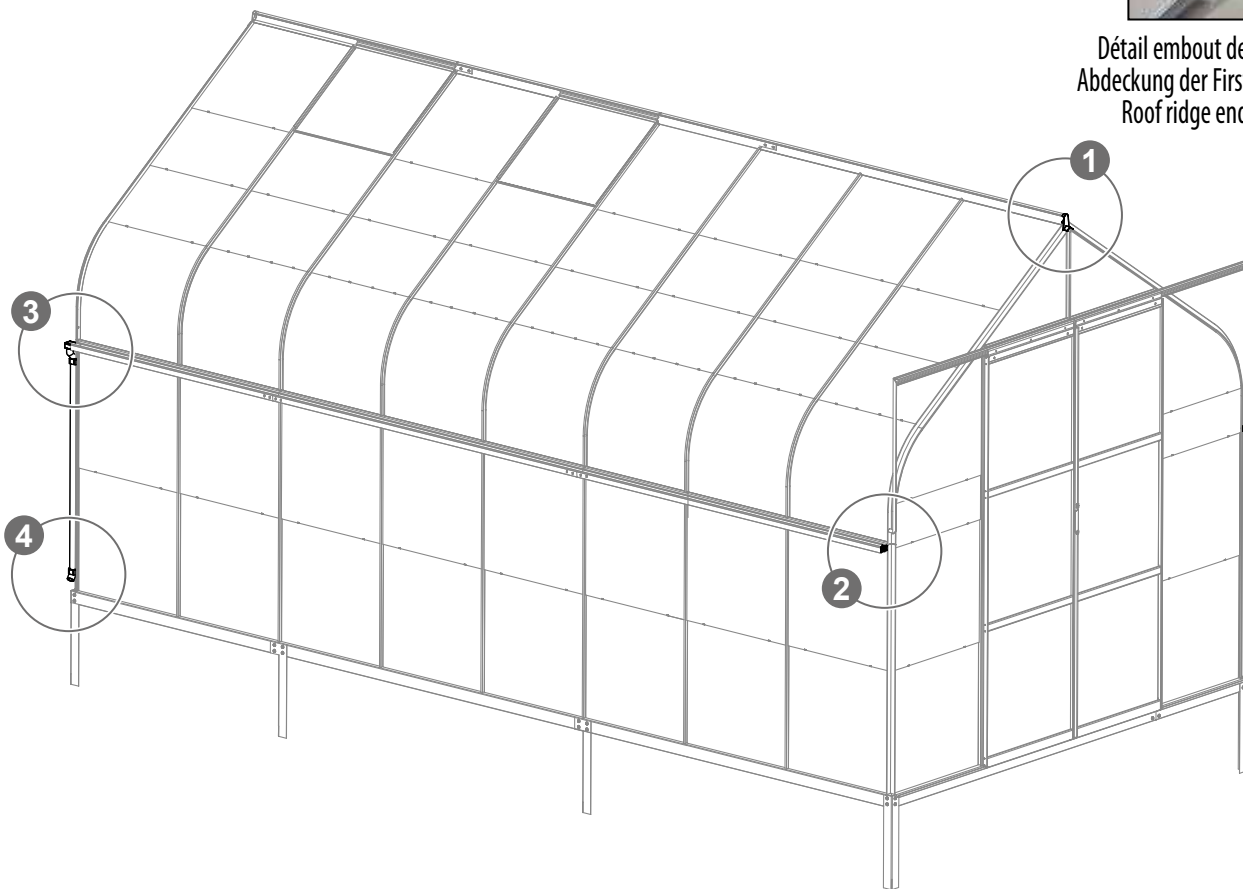

Module de base Basismodul Basic module

	1005 x 4
	2010 x 2
	2022 x 2
	2023 x 2
	2028 x 6
	2033 x 2
	2038 x 2
	58001 x 4

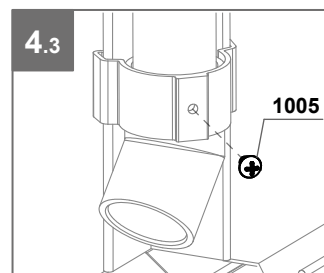
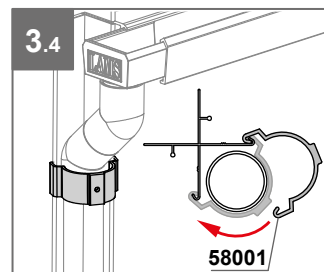
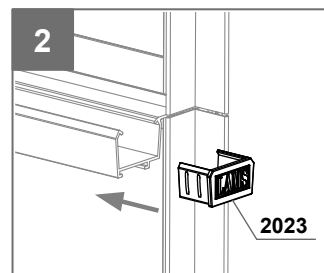
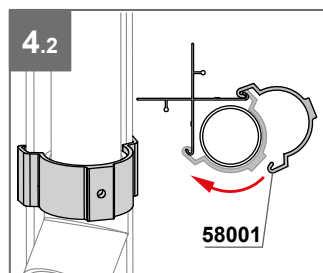
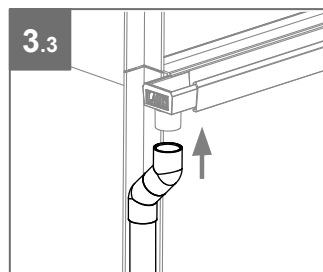
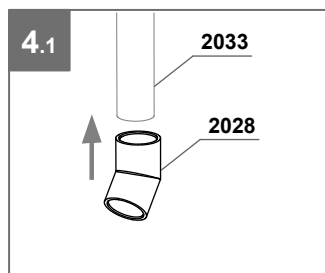
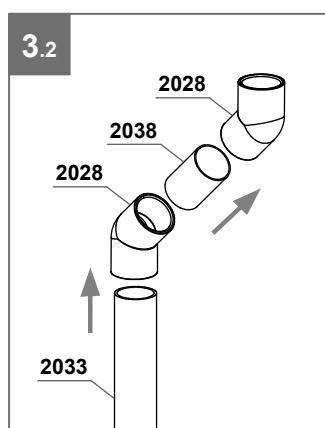
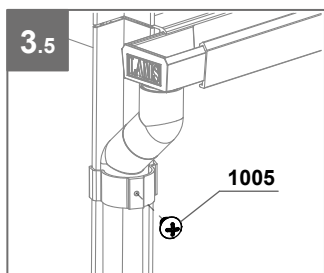
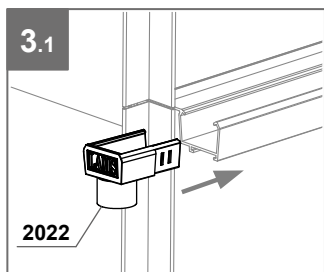
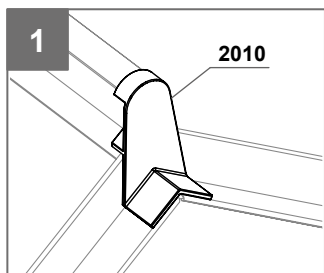

ACCESSOIRES COMPLÉMENTAIRES DISPONIBLES SUR NOTRE SITE ZUSÄTZLICHES ZUBEHÖR AUF UNSERER WEBSITE VERFÜGBAR ADDITIONAL ACCESSORIES AVAILABLE ON OUR WEBSITE



QUELQUES ACCESSOIRES - EINIGE ACCESSOIRES - SOME ACCESSORIES



Système d'ombrage
Beschattungssystem
Shading system

*Permet de réguler la température de votre serre.
Ermöglicht die Temperatur zu regulieren.
Allows to regulate the temperature of your greenhouse.*



Kit descente de gouttière
Regenfallrohr-Set
Rain gutter kit

*Permet de récupérer l'eau de pluie.
Ermöglicht das Auffangen von Regenwasser.
Allows to collect rainwater.*



Ouverture automatique de lucarne
Automatischer Fensteröffner
Automatic window opener

*Système d'aération automatique (à partir de 17°C).
Automatisches Belüftungssystem (ab 17°C).
Automatic aeration system (from 17°C).*



Ventouse
Saugnapf
Suction cup

*Facilite le transport et la pose des verres.
Erleichtert das Tragen und Anbringen der Gläser.
Facilitates the transport and installation of the glass.*



Clips de vitrage à ressort
Federbelastete Gewächshausklammern
Spring glazing clips

*Permettent de maintenir le vitrage des serres.
Halten die Verglasung der Gewächshäuser.
Maintain the glazing of the greenhouses.*



Crochets de vitrage
Verglasungshaken
Glazing hooks

*Permettent de faire chevaucher deux vitrages.
Ermöglicht die Überlappung von zwei Glasscheiben.
Allows the overlap of two glasses.*



WWW.JARDIMAGINE.COM

SERVICE CLIENTS

Site internet : www.sav-doviris.com

KUNDENSERVICE

kontakt@gewaechshaus-lams.com