

LAMS

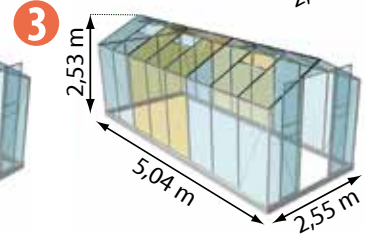
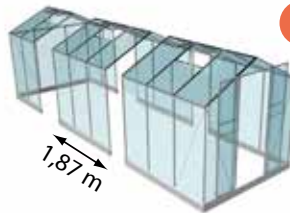
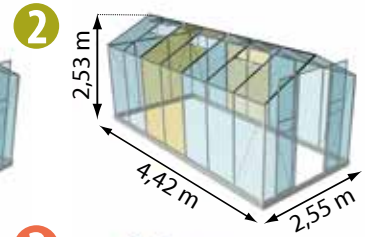
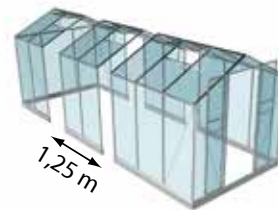
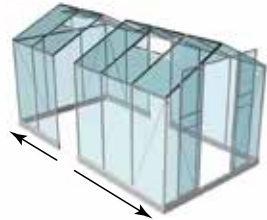
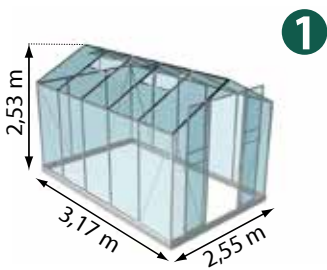
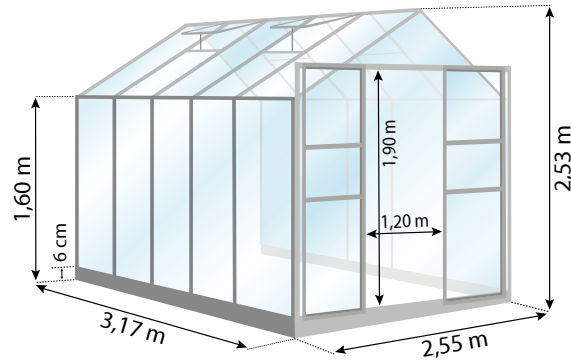

1 Module de base - Basismodul - Basic module
3,17 x 2,55 x 2,53 m (8,10 m²)

2 Extension - Erweiterung - Extension
1,25 x 2,55 x 2,53 m (3,20 m²)

3 Extension - Erweiterung - Extension
1,87 x 2,55 x 2,53 m (4,80 m²)

SERRES - GEWÄCHSHÄUSER - GREENHOUSES

LAURUS

8,10 M² / 11,30 M² / 12,90 M²



NOTICE DE MONTAGE

IMPORTANT

- Merci de lire ces instructions attentivement avant de commencer le montage de la serre.
- Merci de vous assurer que toutes les pièces mentionnées sur cette notice sont présentes dans le carton et de vérifier les quantités.
- Merci de suivre les étapes dans l'ordre indiqué par la notice.
- Veuillez conserver soigneusement ce manuel de montage pour une consultation ultérieure.

CONSEILS DE SÉCURITÉ

- Veuillez porter gants, chaussures et lunettes de protection pour le montage de la serre.
- Respectez les conseils de sécurité des outils que vous utilisez pour ce montage.
- En cas d'intempéries (pluie, vent, orage...), ne montez pas votre serre.
- La serre doit être montée par 2 personnes.
- Les sachets plastiques et les petits composants sont à tenir hors de portée des enfants. Eloignez les enfants de la zone de montage.
- L'aluminium est un métal conducteur d'électricité, tenez les profilés aluminium éloignés de toute source électrique.
- Tout appareil produisant de la chaleur ne doit pas être stocké dans la serre (barbecue, chalumeau, ...).
- La serre doit être positionnée et fixée sur un sol horizontal et plan, non exposé au vent.
- Vérifiez l'absence de réseaux (eau, électricité, gaz) sous l'emplacement de montage de la serre.
- Attention, ne pas monter sur le toit : risque de chute et de blessures graves.
- En cas de forte chute de neige ne pas laisser la neige s'accumuler sur le toit.

CONSEILS D'ENTRETIEN

- Pour nettoyer votre serre, utilisez de l'eau claire savonneuse.
- N'utilisez surtout pas d'acétone, des nettoyants abrasifs ou autres détergents spéciaux pour nettoyer les panneaux.
- Graissez régulièrement le rail de porte.
- Dégagez le toit de la neige et des feuilles.



SERVICE CLIENTS

Site internet : www.sav-doviris.com



MONTAGEANLEITUNG

WICHTIG

- Bitte lesen Sie diese Anleitung sorgfältig durch, bevor Sie mit der Montage beginnen.
- Bitte stellen Sie sicher, dass alle in dieser Anleitung aufgeführten Einzelteile im Karton vorhanden sind und prüfen Sie die Mengen.
- Bitte folgen Sie den Schritten in der im Handbuch angegebenen Reihenfolge.
- Bewahren Sie diese Anleitung für späteres Nachschlagen sorgfältig auf.

SICHERHEITSHINWEISE

- Bitte tragen Sie bei der Montage des Gewächshauses Handschuhe, Schuhe und Schutzbrille.
- Beachten Sie die Sicherheitshinweise der Werkzeuge, die Sie für diese Montage verwenden.
- Stellen Sie Ihr Gewächshaus nicht bei schlechtem Wetter (Regen, Wind, Gewitter . . .) auf.
- Das Gewächshaus muss von 2 Personen zusammengebaut werden.
- Die Plastiktüten und Kleinteile sollten außerhalb der Reichweite von Kindern aufbewahrt werden. Halten Sie die Kinder vom Montagebereich fern.
- Aluminium ist ein elektrisch leitfähiges Metall, halten Sie die Aluminiumprofile von allen elektrischen Quellen fern.
- Wärmezeugenden Geräte (Grill, Brenner, . . .) dürfen im Gewächshaus nicht gelagert werden.
- Das Gewächshaus muss auf einem horizontalen und ebenen, nicht dem Wind ausgesetzten Boden aufgestellt und befestigt werden.
- Stellen Sie sicher, dass es keine Netze (Wasser, Strom oder Gas) unter dem Installationsort gibt.
- Achtung, nicht auf das Dach steigen: Sturz- und schwere Verletzungsgefahr.
- Bei starkem Schneefall den Schnee nicht auf dem Dach ansammeln lassen.

PFLEGEHINWEISE

- Verwenden Sie zur Reinigung Ihres Gewächshauses klares Seifenwasser.
- Verwenden Sie kein Aceton, Scheuermittel oder andere Reinigungsmittel zum Reinigen der Platten.
- Regelmäßig die Türschiene schmieren.
- Räumen Sie das Dach frei von Schnee und Laub.



KUNDENSERVICE

kontakt@gewaechshaus-lams.com



ASSEMBLY INSTRUCTIONS

IMPORTANT

- Please read these instructions carefully before starting to assemble the greenhouse.
- Please ensure that all the components mentioned in this instruction are present in the box and check the quantities.
- Please follow the steps in the order indicated by the manual.
- Please keep this assembly instruction in a safe place for future reference.

SAFETY WARNINGS

- Please wear gloves, shoes and safety goggles when assembling the greenhouse.
- Follow the safety instructions of the tools you use for this assembly.
- In case of bad weather (rain, wind, thunderstorm, ...), do not set up your greenhouse.
- The greenhouse must be assembled by 2 people.
- Plastic bags and small components should be kept out of reach of children. Keep children away from the assembling area.
- Aluminium is a metal with electrical conductivity, keep aluminium profiles away from any electrical source.
- Not all heat-producing appliances (barbecue, torch, ...) can be stored in the greenhouse.
- The greenhouse must be positioned and fixed on a horizontal and even ground, not exposed to wind.
- Check the absence of networks (water, electricity, gas) underneath the installation site of the greenhouse.
- Beware, do not climb on the roof : risk of fall and serious injuries.
- In case of heavy snowfall, do not allow snow to accumulate on the roof.

MAINTENANCE TIPS

- To clean your greenhouse, use clear soapy water.
- Do not use acetone, abrasive cleaners or other special detergents to clean the panels.
- Grease the door rail regularly.
- Clear the roof of snow and leaves.



CUSTOMER SERVICE

Website : www.sav-doviris.com

SOMMAIRE - INHALTSVERZEICHNIS - CONTENTS

1 Module de base 8,10 m² - pages 06 à 34
Basismodul 8,10 m² - Seiten 06 bis 34
Basic modul 8,10 m² - pages 06 to 34

2 Module de base 8,10 m² et extension 3,20 m² - pages 35 à 53
Basismodul 8,10 m² und Erweiterung 3,20 m² - Seiten 35 bis 53
Basic modul 8,10 m² and extension 3,20 m² - pages 35 to 53

3 Module de base 8,10 m² et extension 4,80 m² - pages 54 à 72
Basismodul 8,10 m² und Erweiterung 4,80 m² - Seiten 54 bis 72
Basic modul 8,10 m² and extension 4,80 m² - pages 54 to 72

SERRE - GEWÄCHSHAUS - GREENHOUSE

LAURUS 8,10 M²

RÉFÉRENCES - ARTIKELNUMMERN - CODES :

● ALUMINIUM : 794640 / ● RAL 6009 : 794642 / ● RAL 7016 : 795297

LAURUS 3,20 M²

RÉFÉRENCES - ARTIKELNUMMERN - CODES :

● ALUMINIUM : 795246 / ● RAL 6009 : 795247 / ● RAL 7016 : 795248

LAURUS 4,80 M²

RÉFÉRENCES - ARTIKELNUMMERN - CODES :

● ALUMINIUM : 795249 / ● RAL 6009 : 795250 / ● RAL 7016 : 795251

NUMÉRO DE TRAÇABILITÉ - RÜCKVERFOLGBARKEITSNUMMER - TRACEABILITY NUMBER











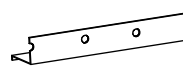
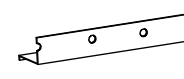
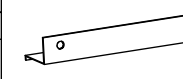
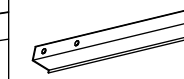
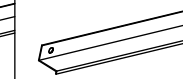
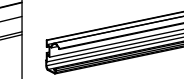





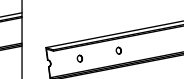



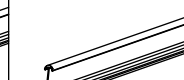





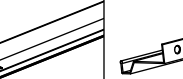
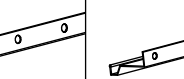

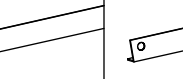
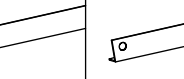
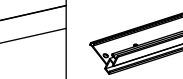
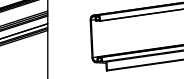
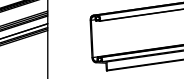

2021.10

NOMENCLATURE - STÜCKLISTE - BILL OF MATERIALS

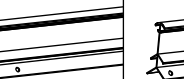
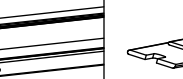
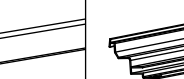
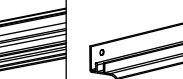
LAURUS 8,10 M²

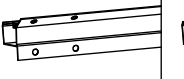

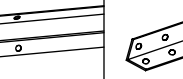
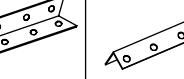
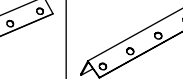
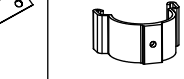
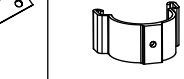
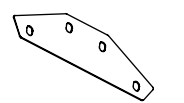
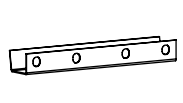
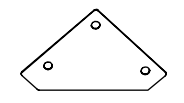
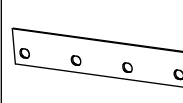
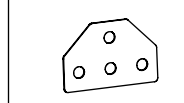
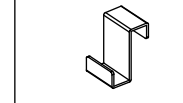
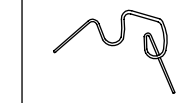
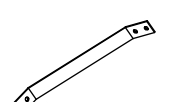
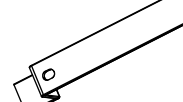
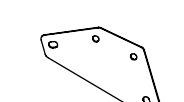
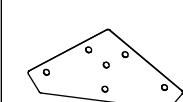
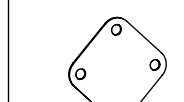
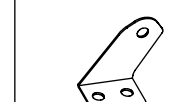







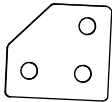
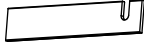

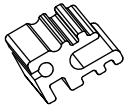
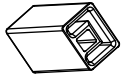
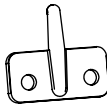
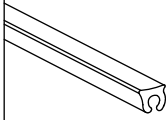

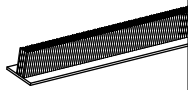
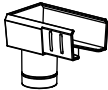

Colis - Paket - Parcel

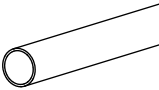
1/2







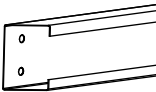
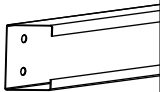
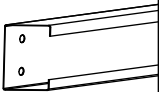

PROFILÉS ALUMINIUM - ALUMINIUMPROFILE - ALUMINIUM PROFILES							
01001 x 1  L:1241 mm	01002 x 1  L:1241 mm	01007 x 1  L:1862.5 mm	01008 x 1  L:1862.5 mm	01009 x 1  L:610 mm	01010 x 1  L:1874 mm	10002 x 2  L:1257 mm	
15001 x 4  L:270 mm	18001 x 2  L:612 mm	20001 x 1  L:100 mm	21001 x 1  L:1922 mm	22001 x 1  L:1922 mm	23001 x 1  L:1235.5 mm	23002 x 1  L:1235.5 mm	
24001 x 4  L:1160 mm	25005 x 16  L:1511 mm	25006 x 1  L:1963 mm	25007 x 2  L:1963 mm	25008 x 2  L:1963 mm	25009 x 2  L:422 mm	27006 x 4  L:1511 mm	
27008 x 1  L:1535 mm	27009 x 1  L:1535 mm	27010 x 1  L:1535 mm	27011 x 1  L:1535 mm	30002 x 1  L:1874 mm	30003 x 1  L:610 mm	32002 x 1  L:1250 mm	32003 x 1  L:1250 mm
33001 x 2  L:393 mm	33002 x 4  L:1885 mm	33003 x 2  L:619 mm	33004 x 2  L:619 mm	33007 x 2  L:1561 mm	33008 x 6  L:1896 mm	34002 x 2  L:1922 mm	35001 x 2  L:621 mm
36001 x 2  L:621 mm	37001 x 4  L:621 mm	38001 x 1  L:1241 mm	38003 x 1  L:1862.5 mm	39001 x 4  L:634 mm	40001 x 4  L:602 mm	41001 x 8  L:518 mm	42001 x 4  L:602 mm
43004 x 1  L:1241 mm	43005 x 1  L:1241 mm	43006 x 1  L:1862.5 mm	43007 x 1  L:1862.5 mm	45001 x 1  L:400 mm	46001 x 4  L:250 mm	46002 x 1  L:200 mm	58001 x 4  L:18 mm
PETITS COMPOSANTS - KLEINTEILE - SMALL COMPONENTS							
W001 x 4 	W002 x 2 	W003 x 15 	W004 x 2 	W005 x 3 	W006 x 108 	W007 x 360 	
W012 x 8 	W013 x 1 	W014 x 4 	W015 x 2 	W016 x 1 	W018 x 1 	W019 x 1 	

NOMENCLATURE - STÜCKLISTE - BILL OF MATERIALS

LAURUS 8,10 M²

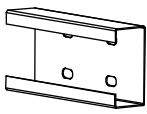
W020 x 2 	W026 x 2 	2001 x 4 	2002 x 4 	2004 x 4 	2005 x 8 	2006 x 105 m 	2010 x 2 
2018 x 2 	2020 x 2  L:1920 mm	2022 x 2 	2023 x 2 	2028 x 2 	2032 x 2 	2034 x 2  L:1410 mm	
1001 x 303  M6	1002 x 277(M6 x 12) 1003 x 15(M6 x 8) 1014 x 1(M6 x 18) 	1004 x 32  M3.5 x 16	1005 x 28  M3.5 x 6	1011 x 8  M6 x 14	1012 x 2  M6 x 5	1015 x 8  Ø 6	









BASE ET VISSERIE - FUNDAMENTRAHMEN UND SCHRAUBEN - GREENHOUSE BASE AND SCREWS

D007 x 4  1894 x 60 x 30 mm	D008 x 2  650 x 60 x 30 mm	D009 x 2  1272 x 60 x 30 mm	D011x 4 	D012 x 2 	D013 x 4 	D014 x 4 
1008 x 32  Ø 6	1009 x 32  M6 x 12 mm	1010 x 32  M6	W008 x 21 			

Colis - Paket - Parcel

2/2

VERRES - GLÄSER - GLAZING

1 x 4  610 x 610 mm	5 x 4  600 x 544 mm	9 x 2  610 x 461 mm	11 x 4  610 x 434/8 mm	12 x 4  610 x 468/44 mm	13 x 2  610 x 540 mm	14 x 58  610 x 509 mm
					15 x 10  610 x 487 mm	16 x 6  610 x 549 mm

**OUTILS INCLUS
VORHANDENES WERKZEUG
TOOLS INCLUDED**

**NON INCLUS
NICHT VORHANDEN
NOT INCLUDED**



M6/10 mm

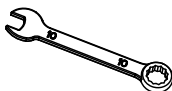

M6/10 mm



10 m

MONTAGE BASE - MONTAGE FUNDAMENTRAHMEN - BASE ASSEMBLING

Il est impératif que la base soit montée de niveau.



Es ist zwingend erforderlich, dass der Fundamentrahmen auf einem ebenen Untergrund montiert wird.

It is imperative that the greenhouse base is leveled.

Module de base
Basismodul
Basic module

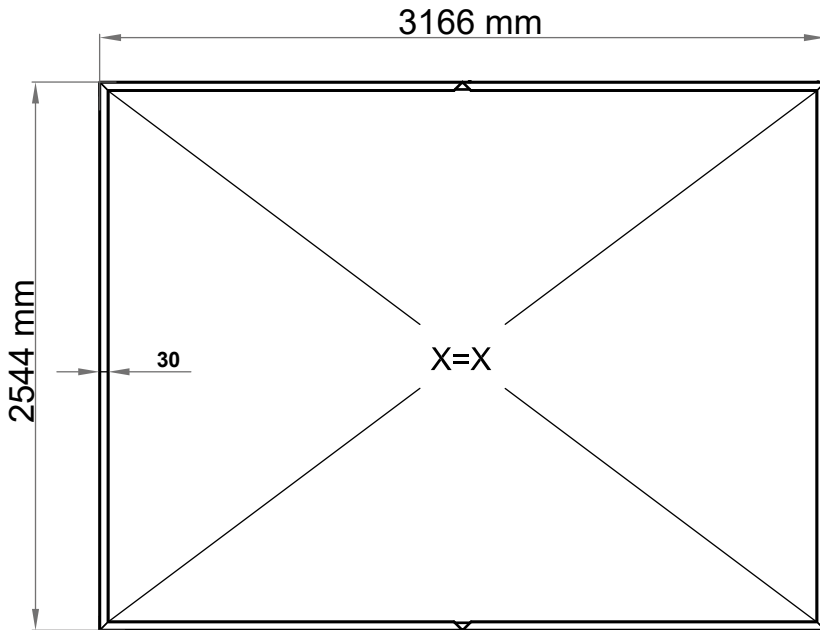

FACE AVANT (AVEC PORTE)
VORDERWAND (MIT TÜR)
FRONT WALL (WITH DOOR)

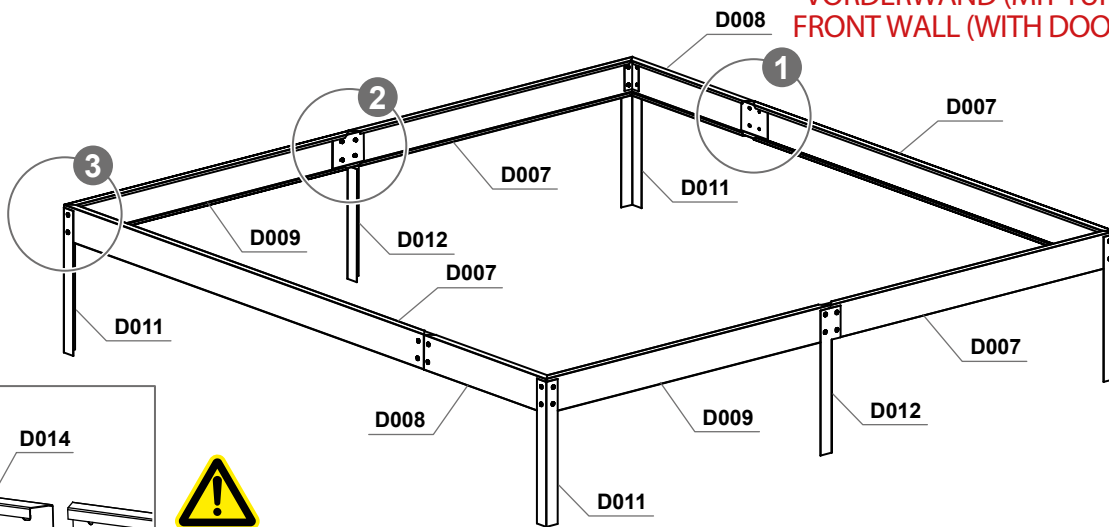

Plots béton / Punktfundament / Point foundation : D013 + D011 + D012.
Dalle ou pourtour béton / Streifenfundament / Concrete slab or frame : D013.

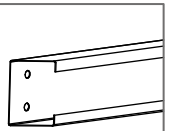
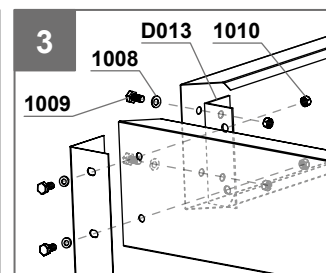
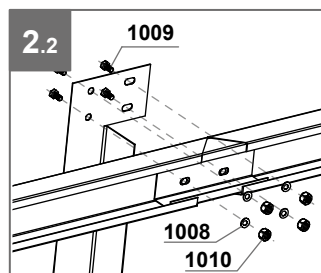
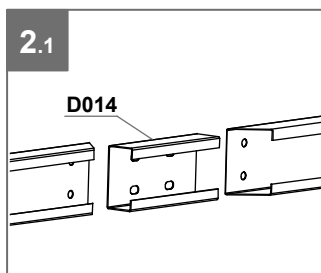
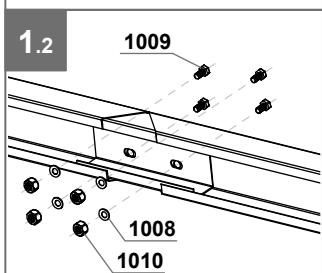
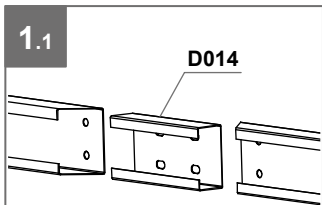

D007 x 4

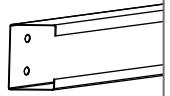

D008 x 2

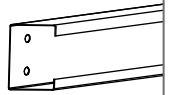

D009 x 2

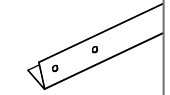

D011 x 4

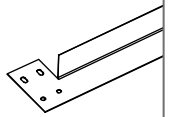

D012 x 2

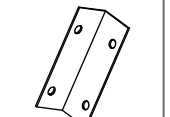

D013 x 4

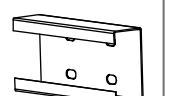

D014 x 4

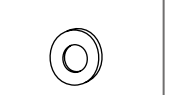

1008 x 32

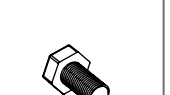

1009 x 32



1010 x 32



FIXATION DE LA BASE AU SOL

FIXATION EN PLEINE TERRE

- Positionner la base à l'endroit voulu, de niveau sur un sol damé.
- Repérer l'emplacement des pattes de scellement suivant le schéma ci-dessous.
- Marquer un carré de 300 x 300 mm autour des pattes de scellement et creuser sur une profondeur de 450 mm.
- Placer la base, la mettre de niveau et remplir les trous de béton.

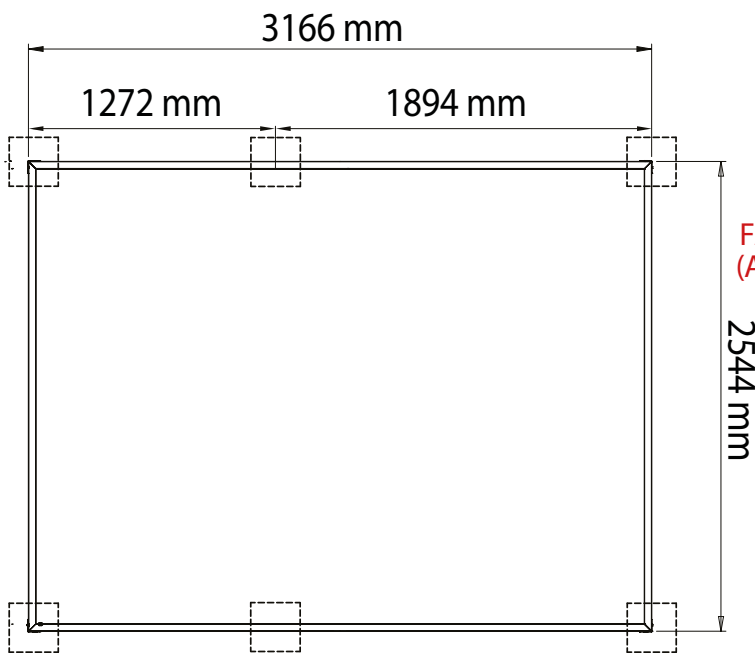

FACE AVANT
(AVEC PORTE)

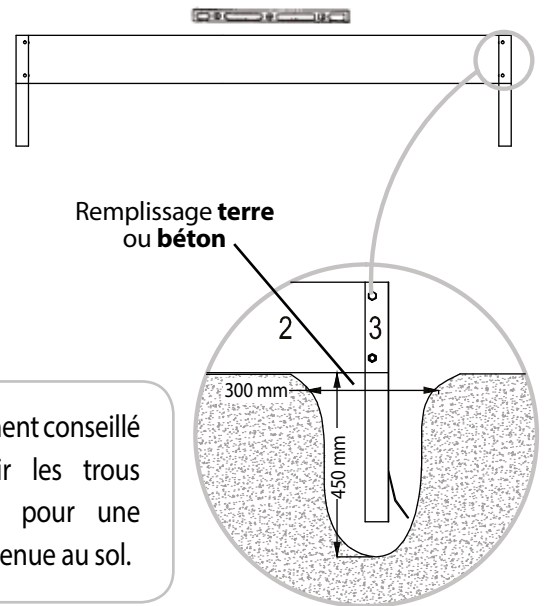

Il est vivement conseillé de remplir les trous de béton pour une meilleure tenue au sol.

OU

FIXATION SUR DALLE BÉTON

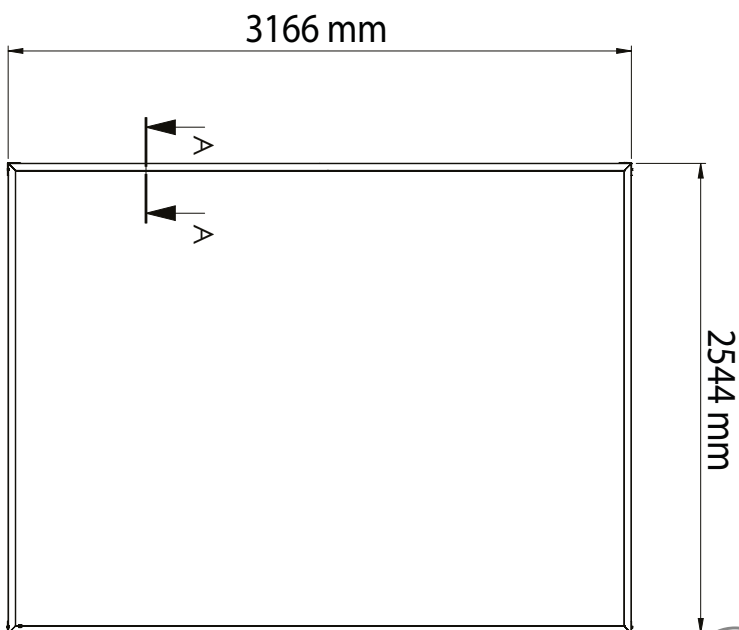

Détail A-A

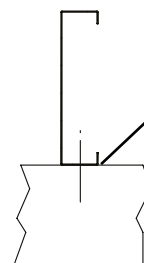

Fixation par chevilles à l'intérieur de la base



Visseries et chevilles de fixation non fournies

Il est laissé à votre libre choix et décision, l'utilisation des fixations adéquats selon les supports que vous décidez d'utiliser (pourtour bois, parpaings, plaques ciment, ...).



BEFESTIGUNG DES FUNDAMENTRAHMENS AM BODEN

BEFESTIGUNG AUF ERDBODEN (Punktfundament)

- Stellen Sie den Fundamentrahmen an der gewünschten Stelle, auf einem ebenen Boden.
- Finden Sie die Stelle der Ankerbeine gemäß dem untenstehenden Schema.
- Markieren Sie ein 300 x 300 mm Quadrat um die Ankerbeine herum und graben Sie 450 mm tief.
- Den Fundamentrahmen platzieren, nivellieren und die Löcher mit Beton füllen.

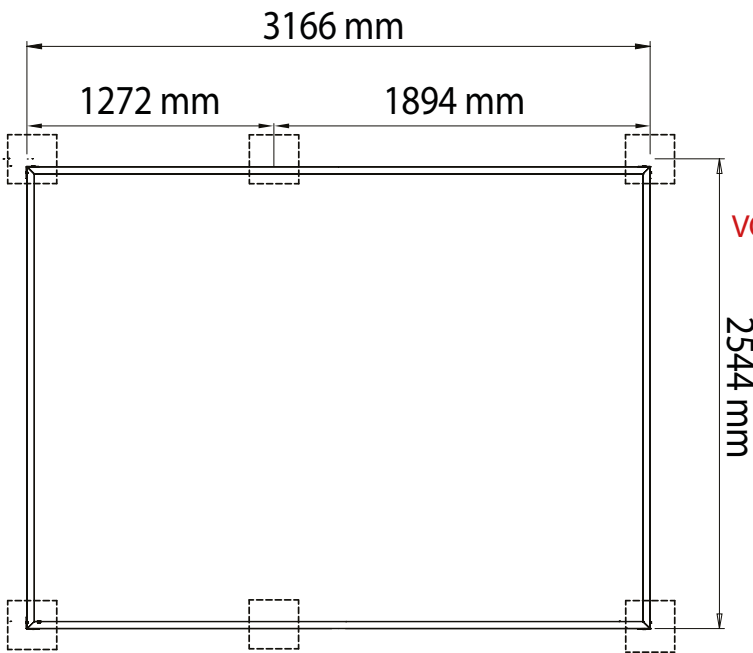

VORDERWAND
(MIT TÜR)

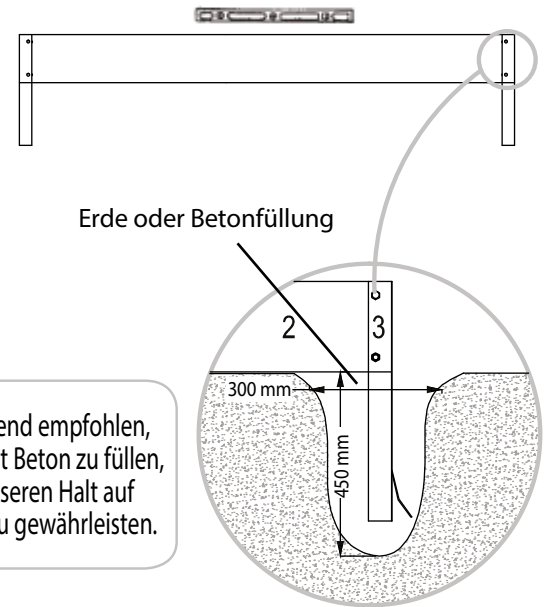

Es wird dringend empfohlen,
die Löcher mit Beton zu füllen,
um einen besseren Halt auf
dem Boden zu gewährleisten.

ODER

BEFESTIGUNG AUF BETONDECKE (Streifenfundament)

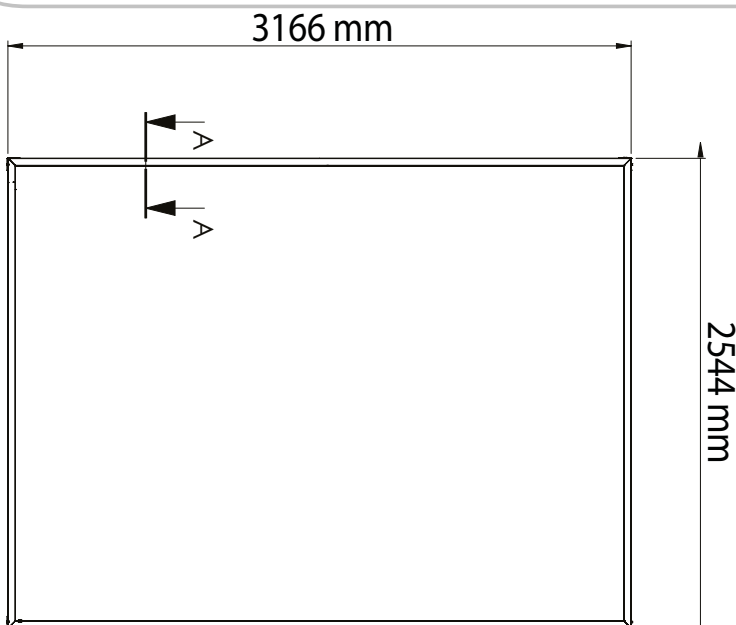

Detail A-A

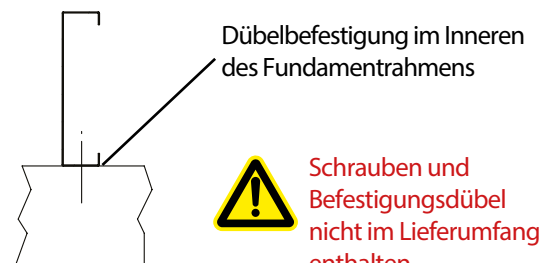

Schrauben und
Befestigungsdübel
nicht im Lieferumfang
enthalten

Es bleibt Ihrer freien Wahl und Entscheidung
überlassen, die geeigneten Befestigungsmittel
entsprechend der von Ihnen gewählten Träger
(Holzumrandung, Bausteine, Zementplatten,...)
zu verwenden.



FIXING THE GREENHOUSE BASE TO THE GROUND

FIXING ON SOIL (POINT FOUNDATION)

- Position the greenhouse base in the desired location at a level position.
- Locate the base legs as shown bellow.
- Mark a 300 x 300 mm square around the base legs and dig 450 mm deep.
- Place the greenhouse base, level it and fill the holes with concrete.

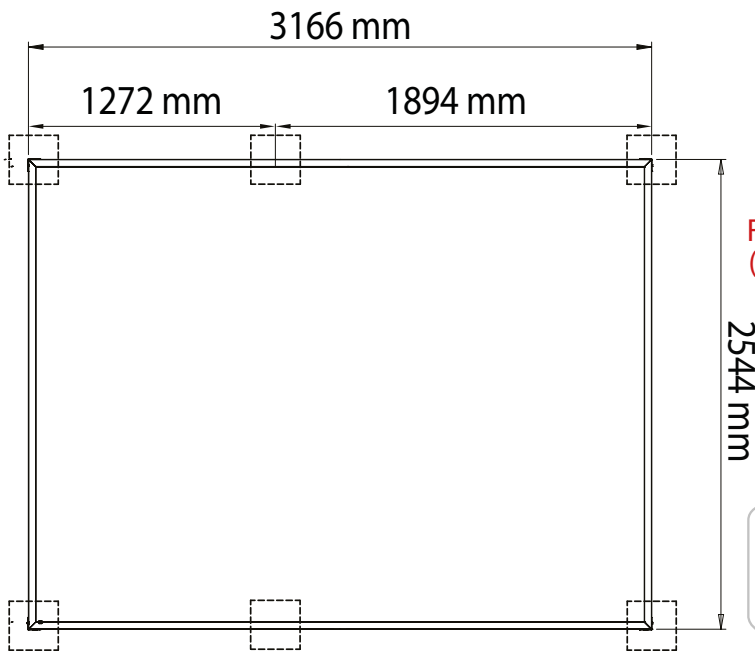

**FRONT WALL
(WITH DOOR)**

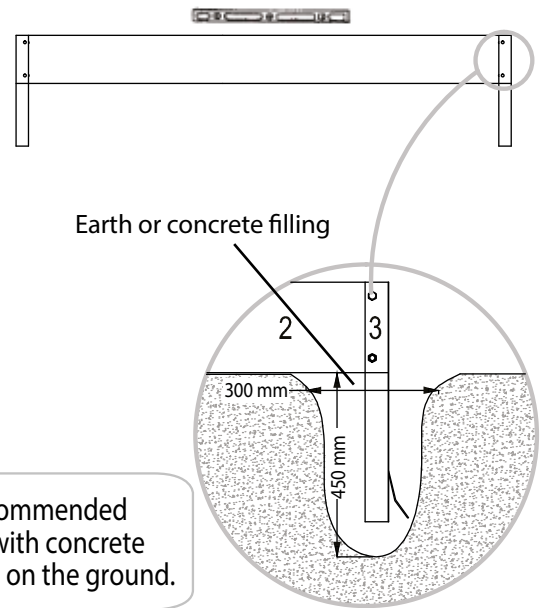

It is strongly recommended to fill the holes with concrete for a better hold on the ground.

OR

FIXING ON CONCRETE SLAB

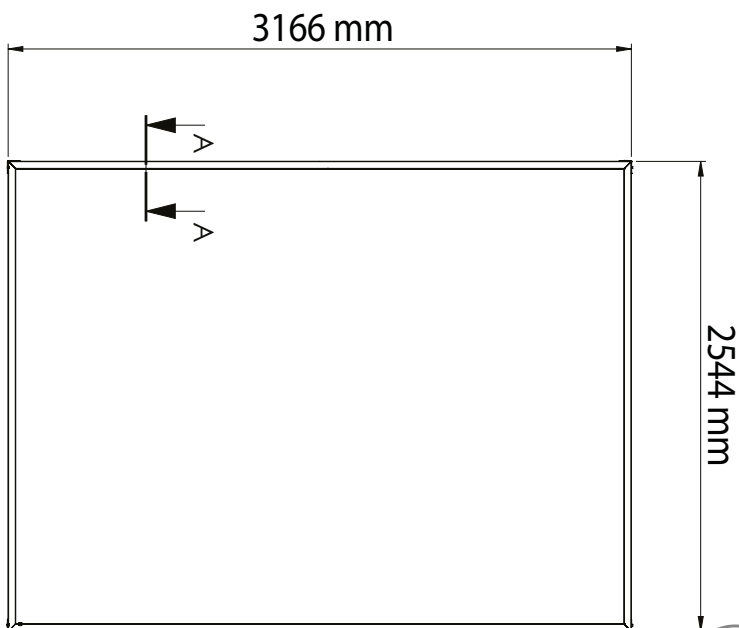

Detail A-A

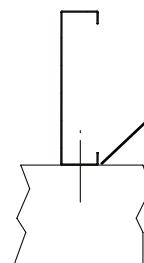

Rawplug fastening inside the greenhouse base



Screws and rawplugs not provided

It remains to your free choice and decision to use the suitable fastening means according to the supports you chose (wood border, building stones, cement plates etc.)

VIS 1002 & 1003 - SCHRAUBEN 1002 & 1003 - SCREWS 1002 & 1003

Mise en place des vis 1002 et 1003 dans les rainures en forme de T des profilés aluminium :
Entrez la tête de vis dans la rainure du profilé et tournez à 90° afin qu'elle ne puisse pas sortir du profilé. Assemblez la/les pièce(s) nécessaire(s) et serrez l'écrou.

Verwendung der Schrauben 1002 und 1003 in den t-förmigen Nuten der Aluminiumprofile :
Schraubenkopf in die Profilmutter stecken und diesen um 90° drehen, damit er nicht aus dem Profil herauskommt. Bauen Sie das/die benötigte(n) Einzelteil(e) zusammen und ziehen Sie die Schraubenmuttern an.

Principle of use of screws 1002 and 1003 in the T-shaped grooves of the aluminium profiles :
Enter the screw head into the groove of the profile and turn the screw head at 90° so that it cannot exit the profile. Assemble the required part(s) and tighten the screw nut.

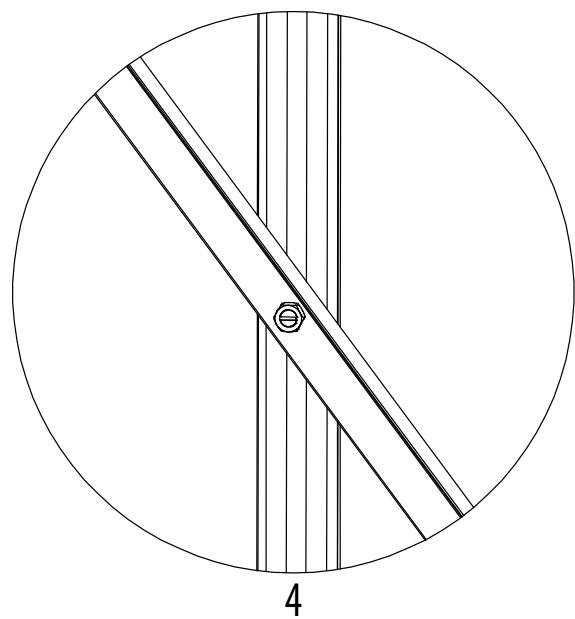
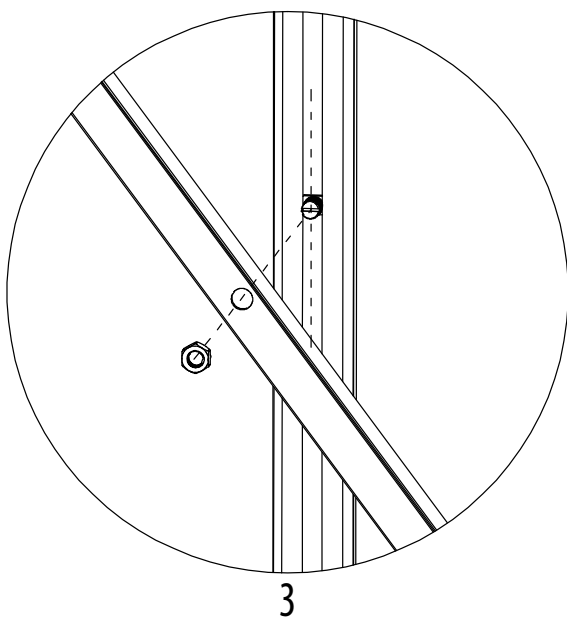
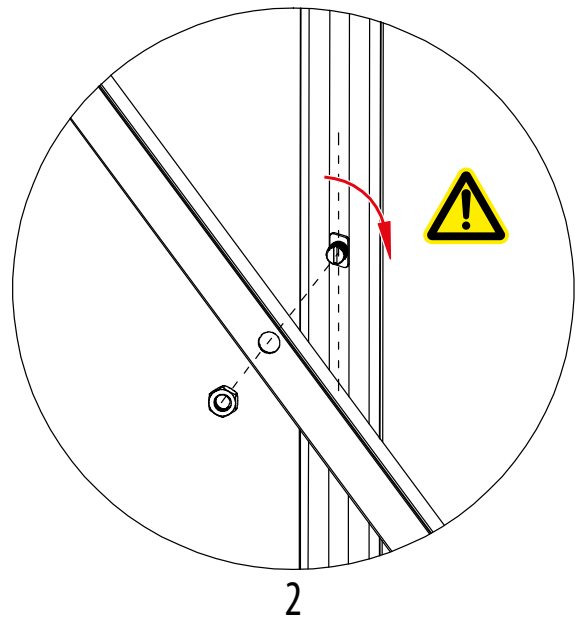
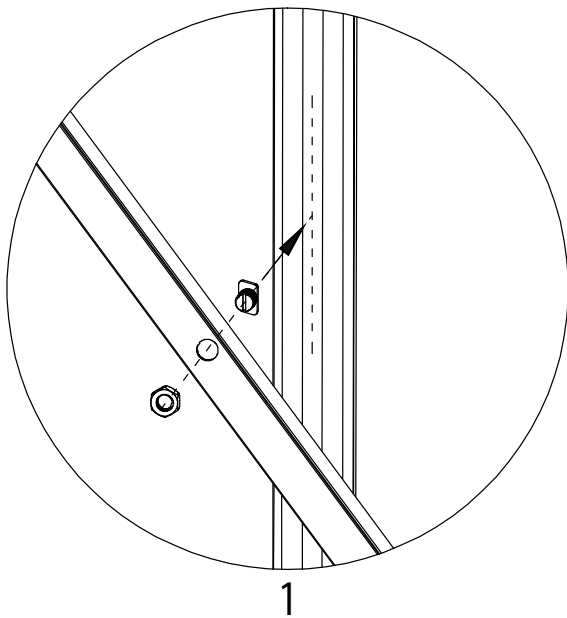



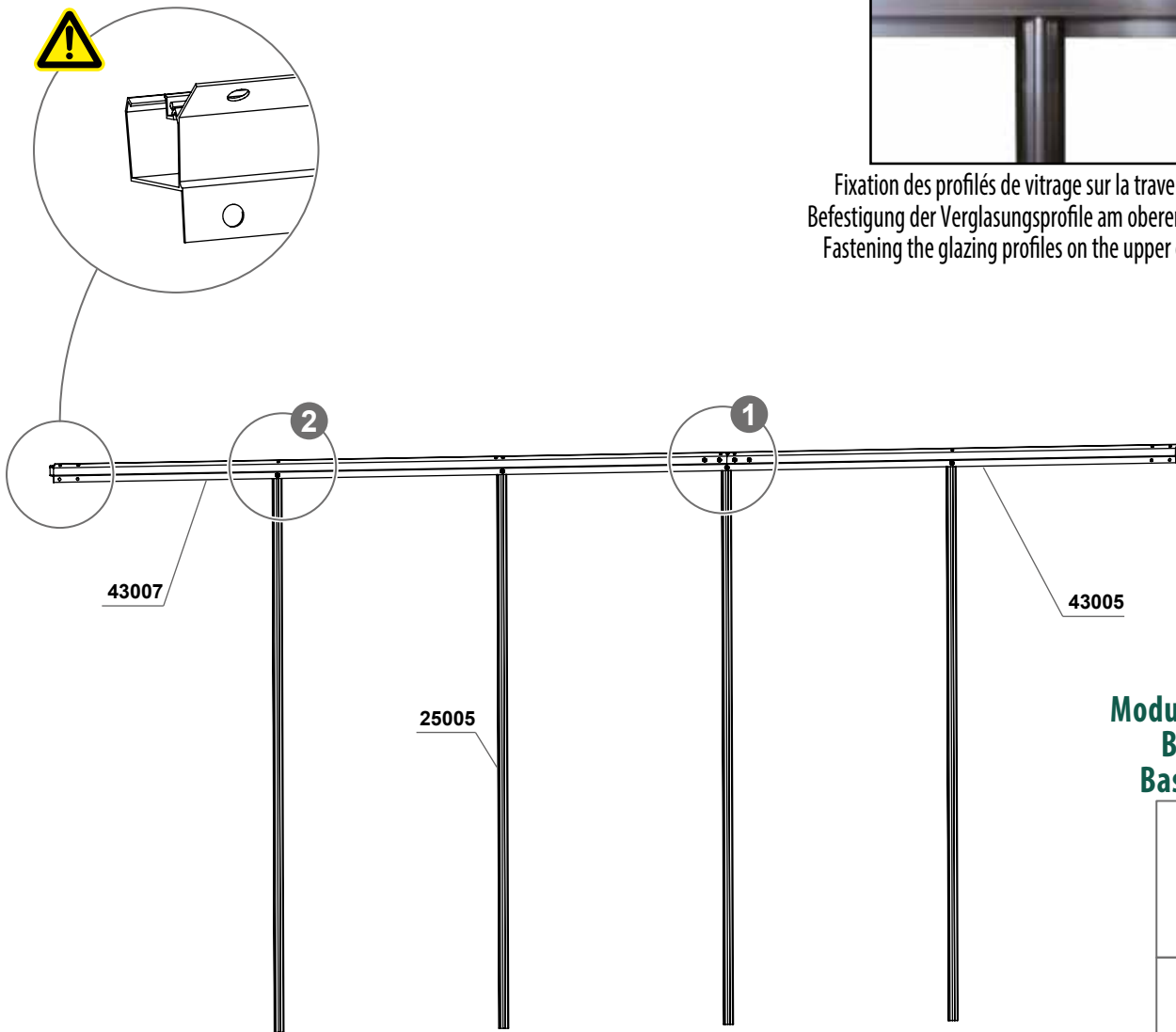

LONG-PAN (CÔTÉ) A1 - SEITENWAND A1 - SIDE WALL A1

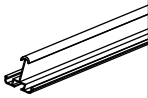
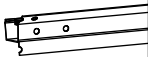

Fixation des profilés de vitrage sur la traverse haute.
 Befestigung der Verglasungsprofile am oberen Querträger.
 Fastening the glazing profiles on the upper crossbeam.

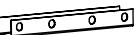
Module de base Basismodul Basic module

- 
25005 x 4
- 
43005 x 1
- 
43007 x 1
- 
W002 x 1
- 
1001 x 8
- 
1002 x 8

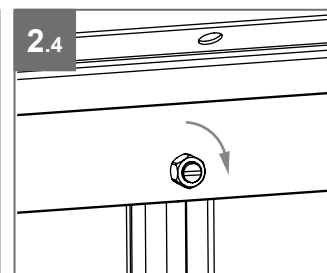
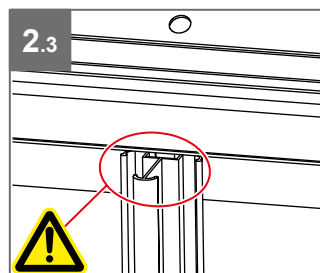
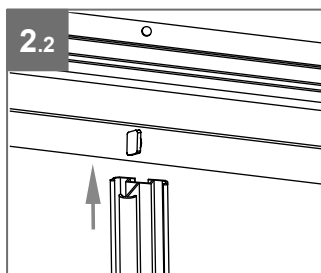
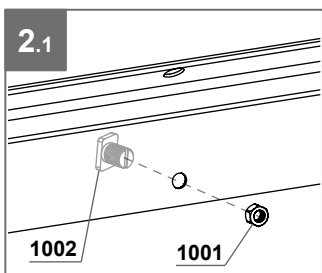
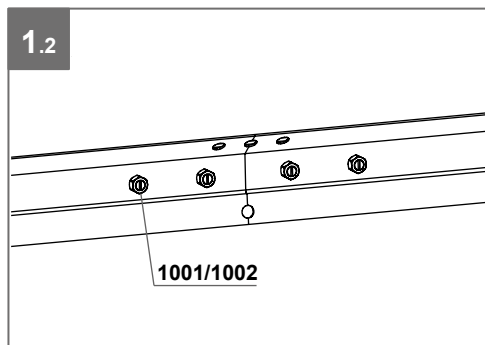
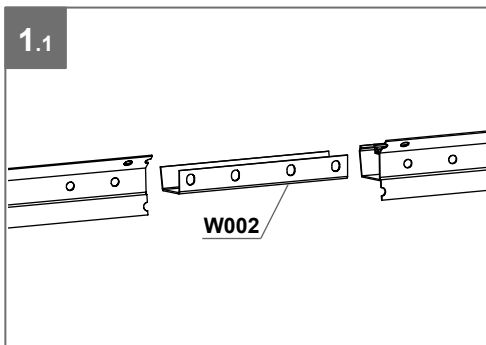

LONG-PAN (CÔTÉ) A1 - SEITENWAND A1 - SIDE WALL A1

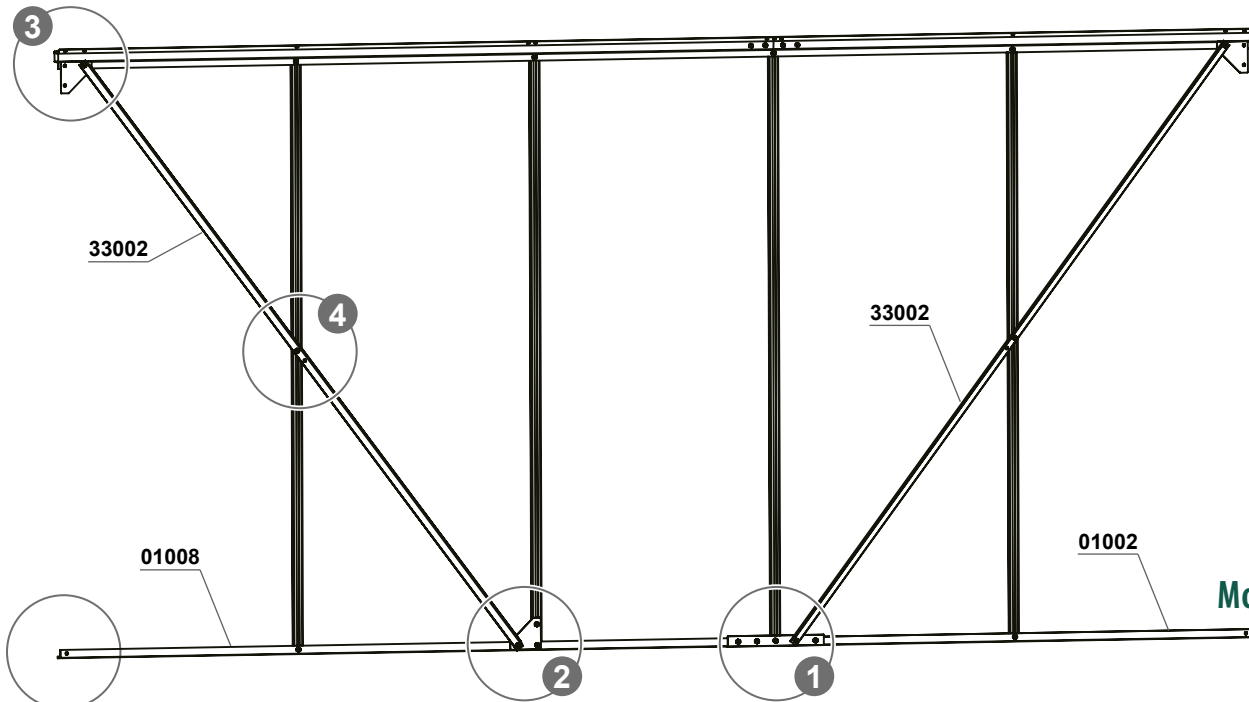

Module de base
Basismodul
Basic module

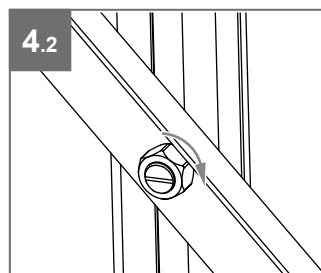
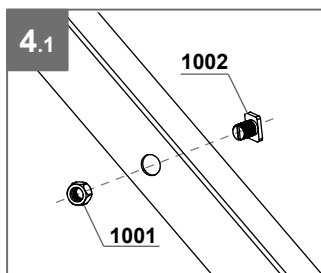
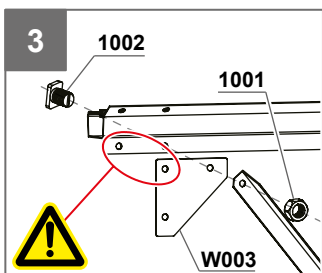
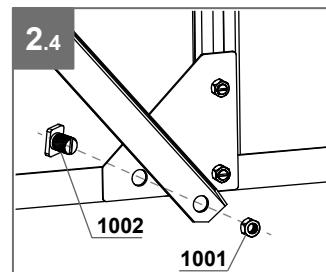
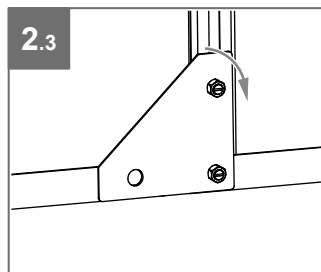
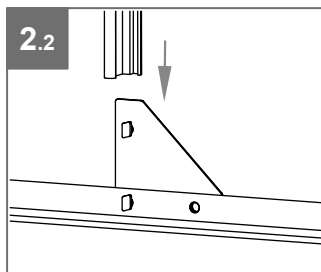
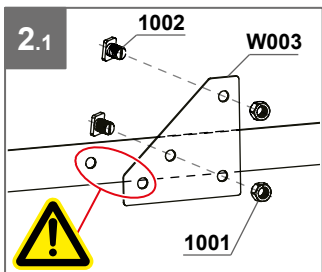
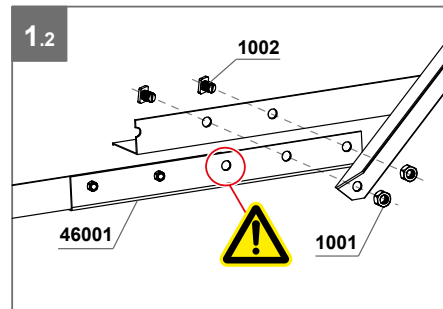
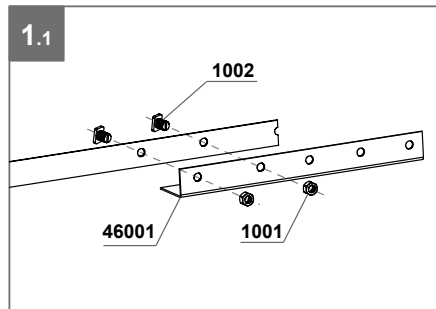
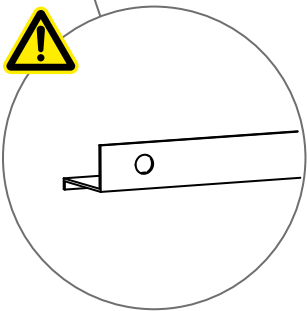

- 01002 x 1
- 01008 x 1
- 33002 x 2
- 46001 x 1
- 1001 x 14
- 1002 x 14
- W003 x 3



LONG-PAN (CÔTÉ) A2 - SEITENWAND A2 - SIDE WALL A2

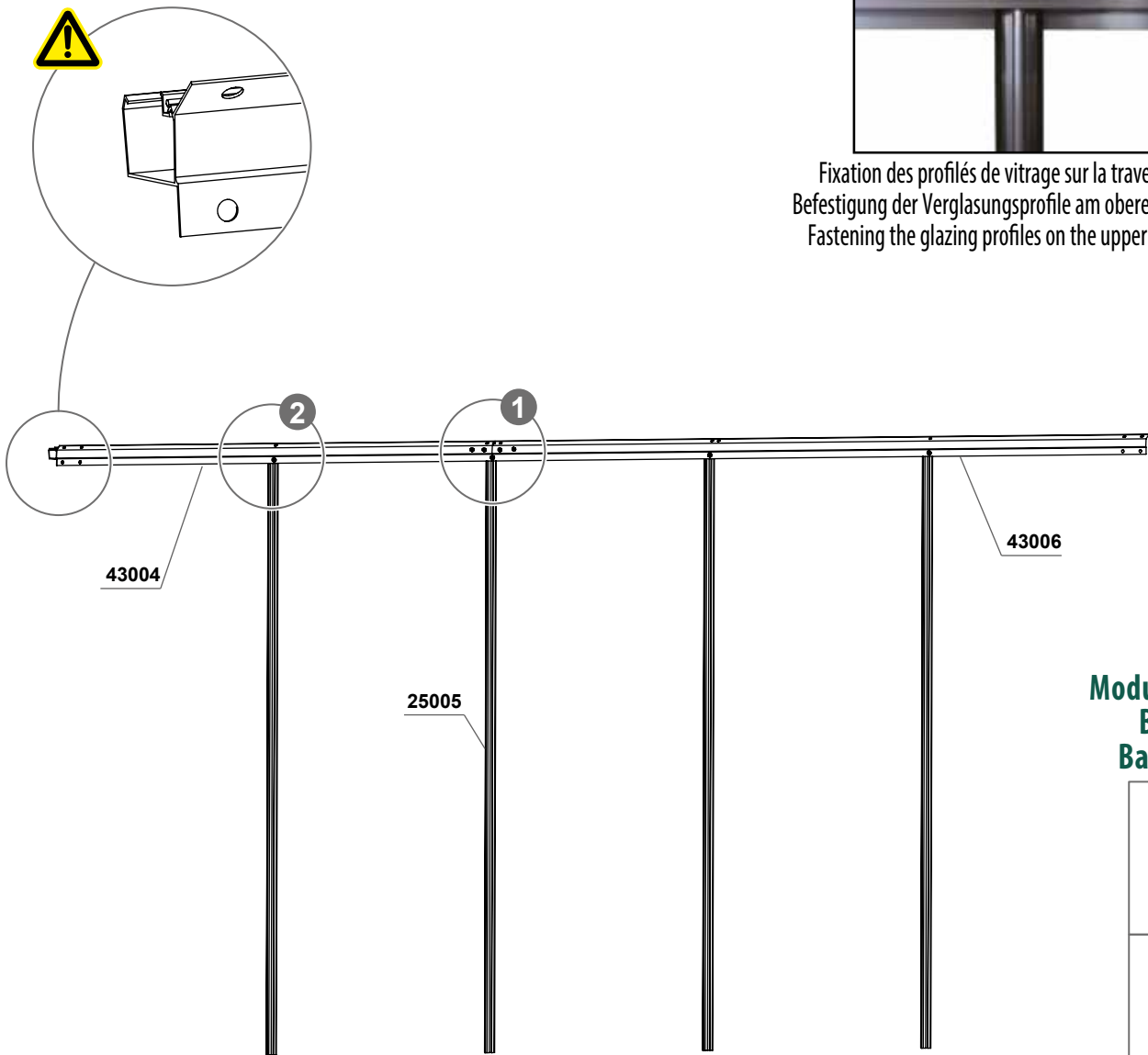

Fixation des profilés de vitrage sur la traverse haute.
 Befestigung der Verglasungsprofile am oberen Querträger.
 Fastening the glazing profiles on the upper crossbeam.

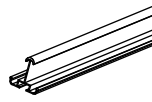
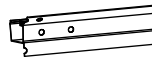
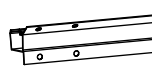
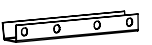

Module de base Basismodul Basic module

-  25005 x 4
-  43006 x 1
-  43004 x 1
-  W002 x 1
-  1001 x 8
-  1002 x 8

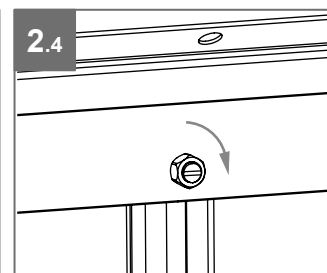
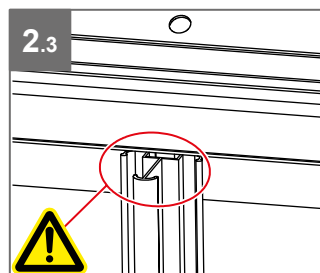
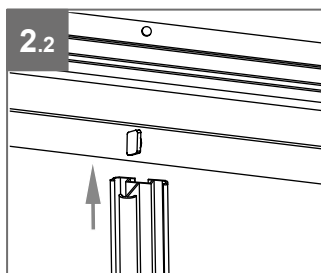
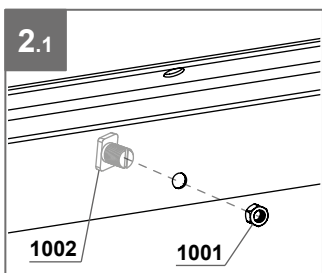
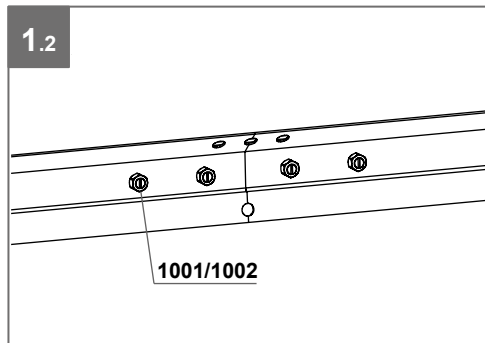
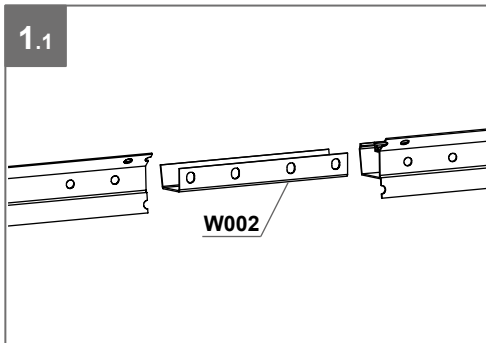



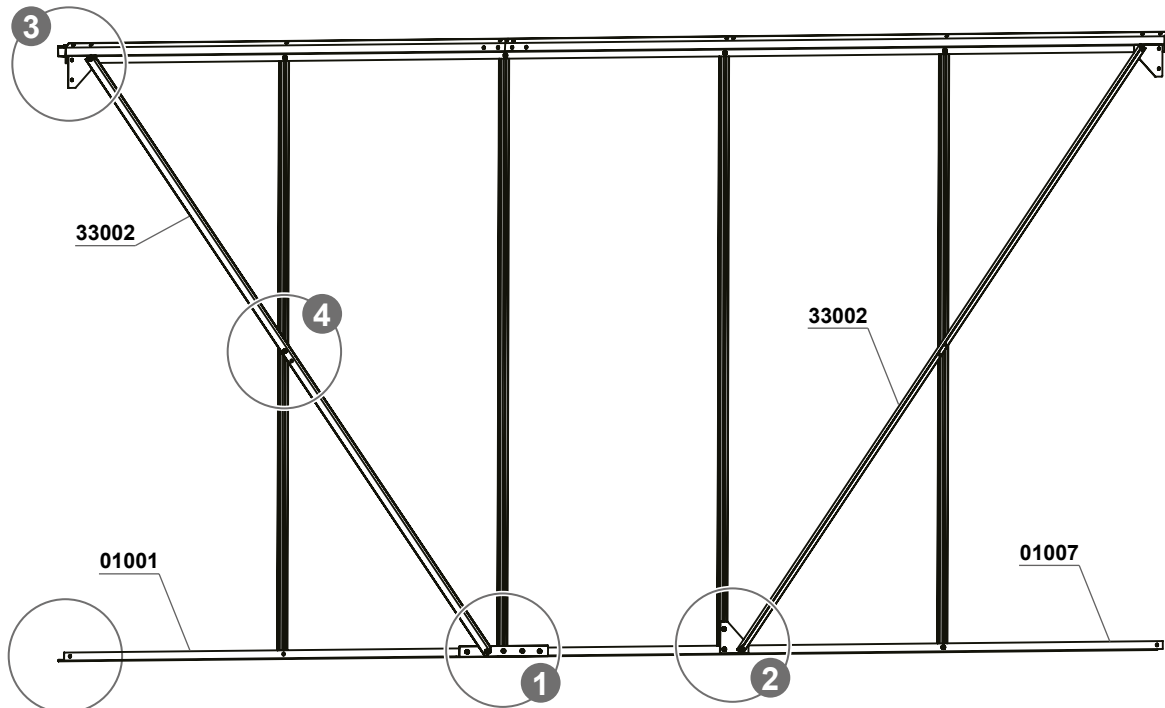

LONG-PAN (CÔTÉ) A2 - SEITENWAND A2 - SIDE WALL A2

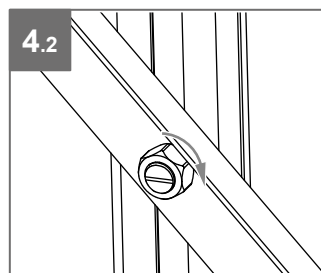
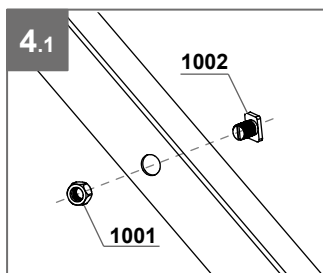
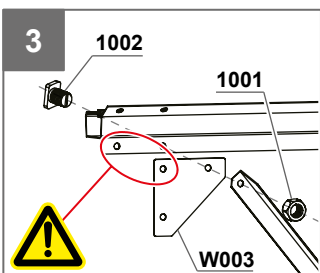
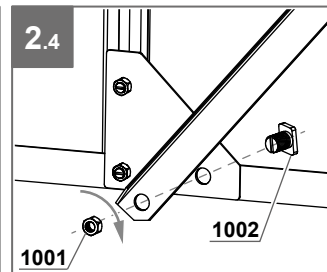
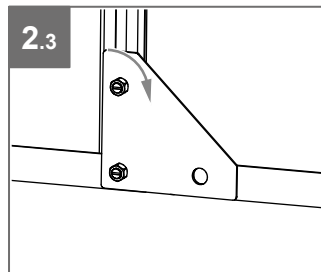
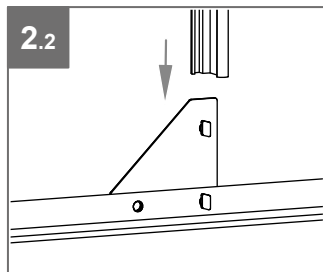
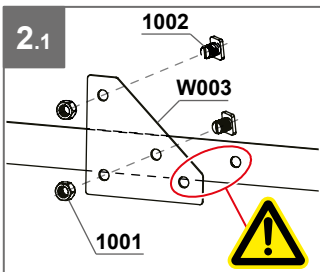
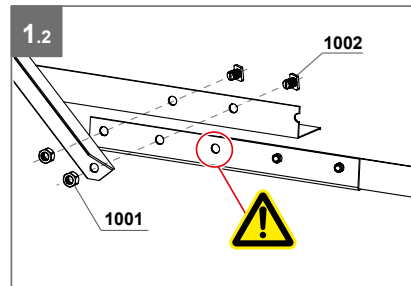
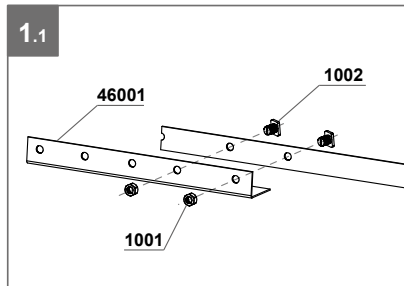
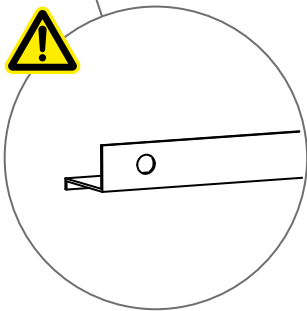

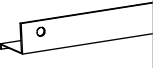
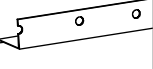
Module de base
Basismodul
Basic module

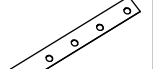

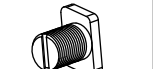
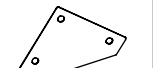

- 
01001 x 1
- 
01007 x 1
- 
33002 x 2
- 
46001 x 1
- 
1001 x 14
- 
1002 x 14
- 
W003 x 3

FACE AVANT (AVEC PORTE) - VORDERWAND (MIT TÜR)

FRONT WALL (WITH DOOR)

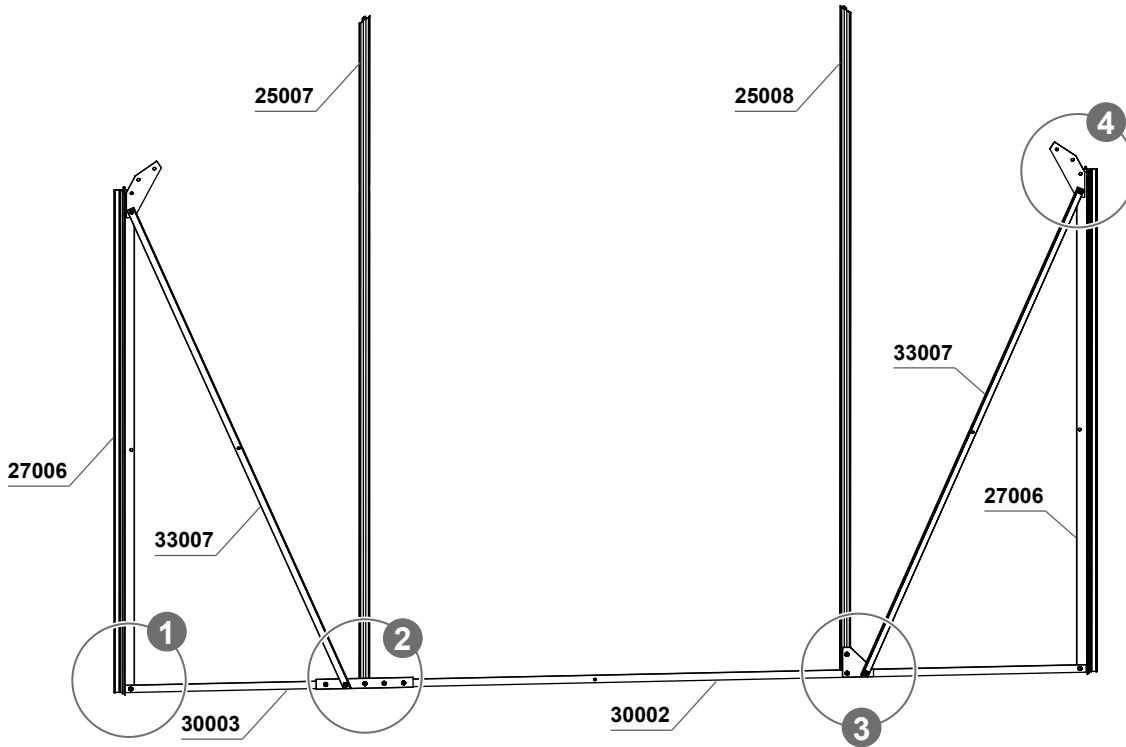
Module de base Basismodul Basic module

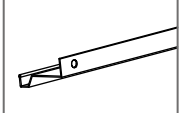
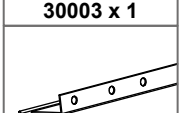

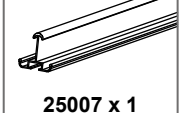
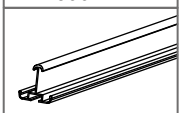
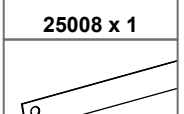
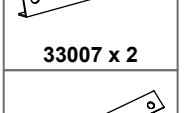
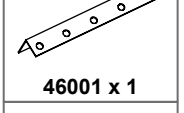
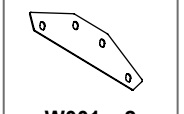
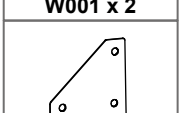
-  30003 x 1
-  30002 x 1
-  27006 x 2
-  25007 x 1
-  25008 x 1
-  33007 x 2
-  46001 x 1
-  W001 x 2
-  W003 x 1
-  1001 x 12
-  1002 x 12

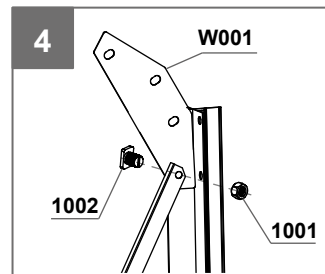
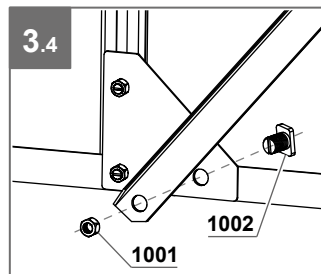
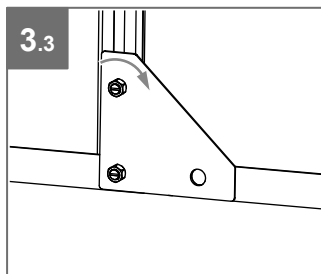
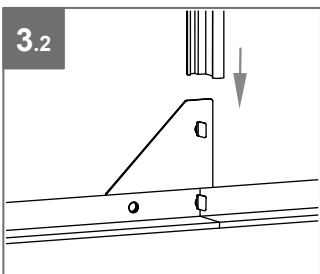
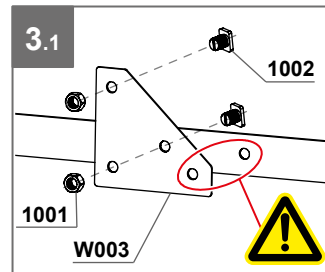
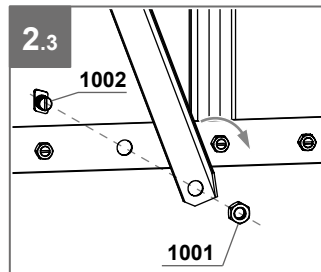
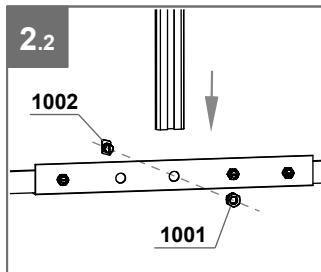
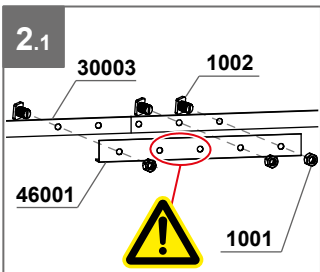
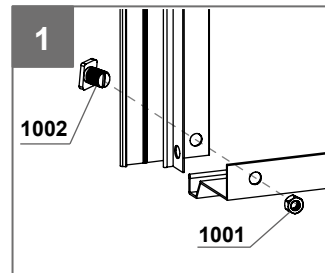

FACE AVANT (AVEC PORTE) - VORDERWAND (MIT TÜR) FRONT WALL (WITH DOOR)

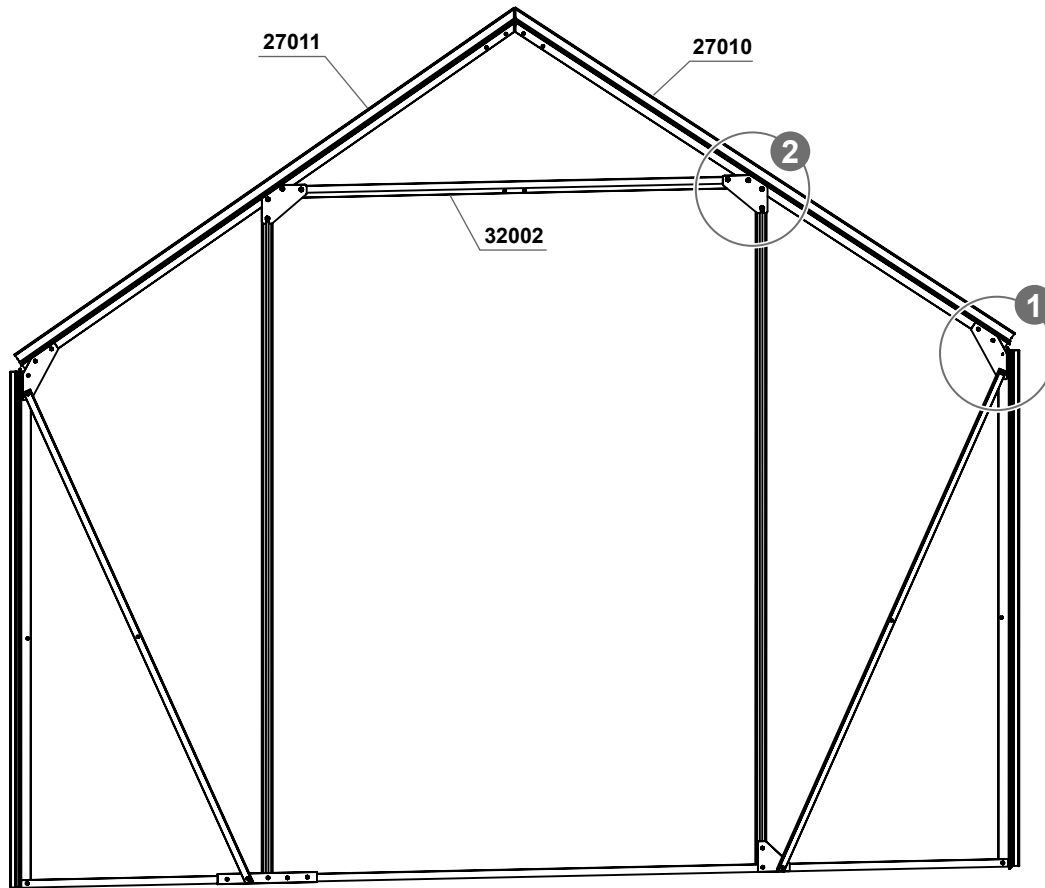

Module de base Basismodul Basic module

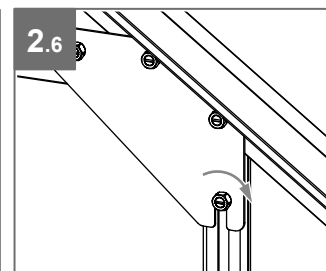
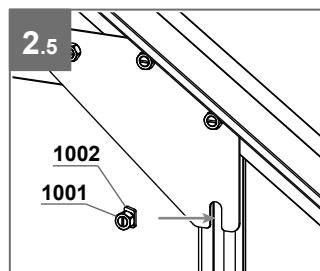
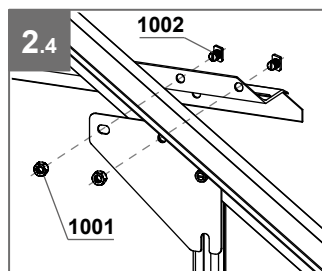
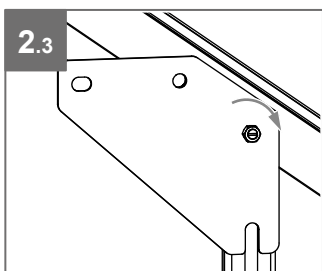
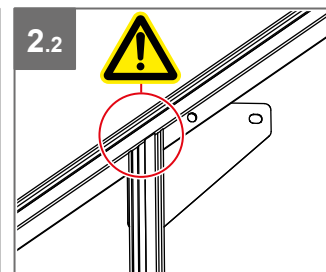
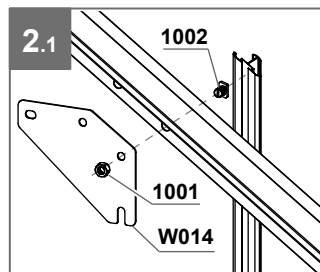
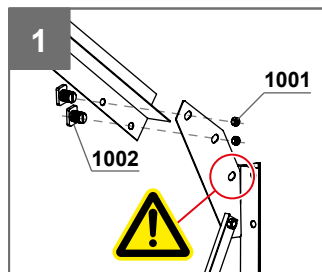
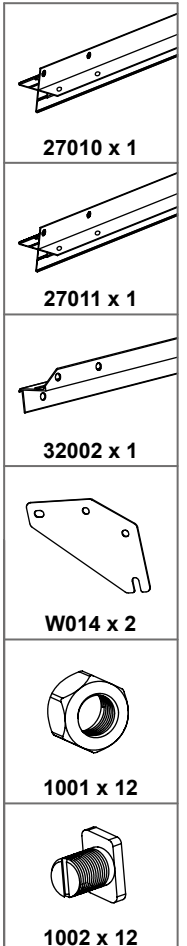

FACE AVANT (AVEC PORTE) - VORDERWAND (MIT TÜR) FRONT WALL (WITH DOOR)

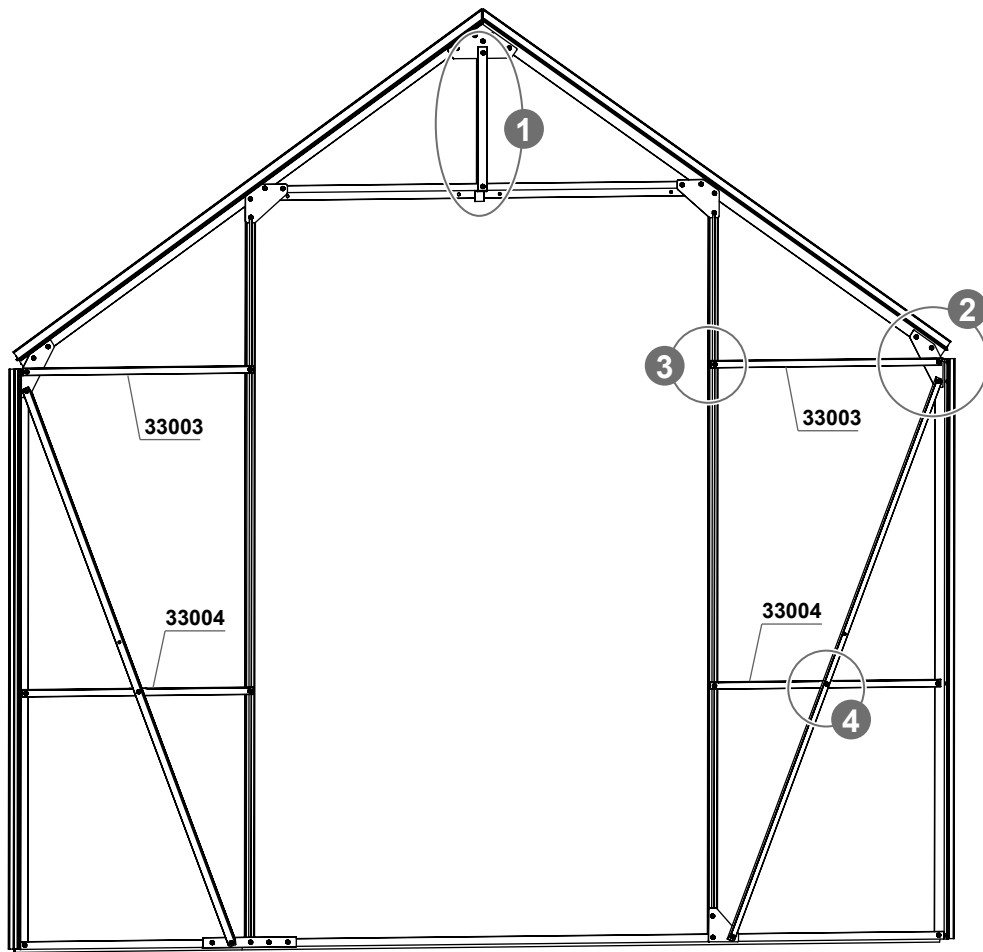

Module de base Basismodul Basic module

	25009 x 1
	33003 x 2
	33004 x 2
	W013 x 1
	W015 x 1
	1001 x 17
	1002 x 16
	1014 x 1

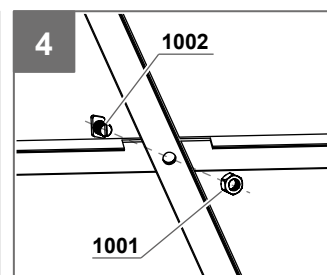
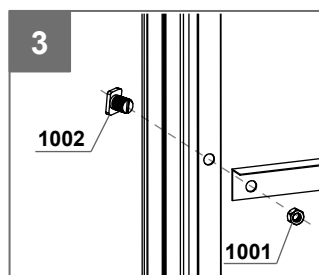
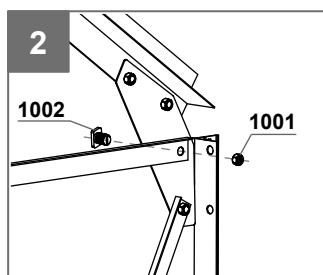
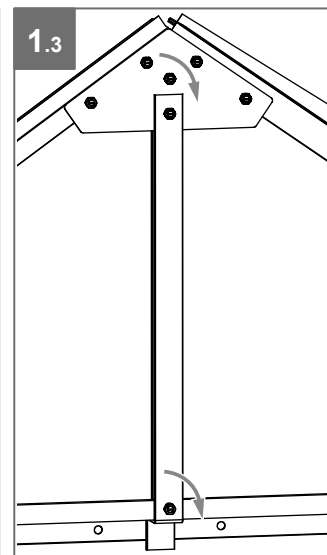
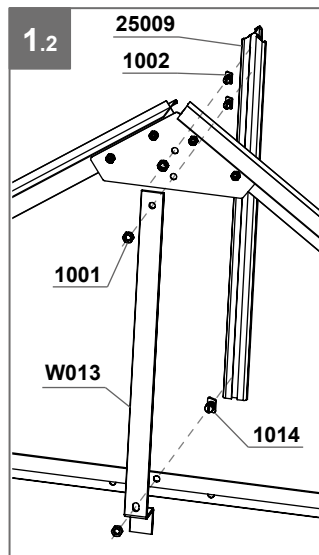
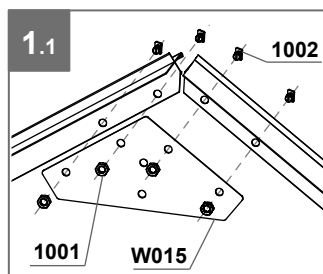

FACE ARRIÈRE (SANS PORTE) - RÜCKWAND (OHNE TÜR) REAR WALL (WITHOUT DOOR)

Module de base
Basismodul
Basic module

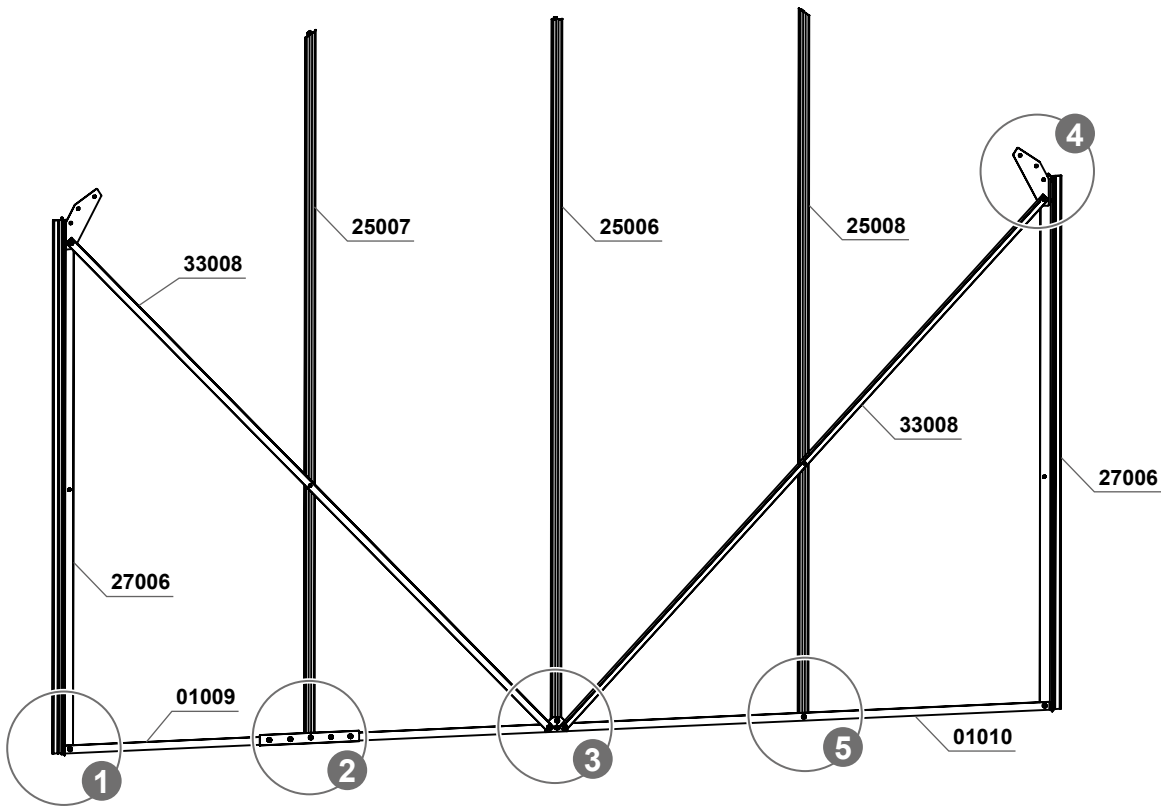

	01009 x 1
	01010 x 1
	25006 x 1
	25007 x 1
	25008 x 1
	27006 x 2
	33008 x 2
	46001 x 1
	W001 x 2
	W005 x 1
	1001 x 14
	1002 x 14

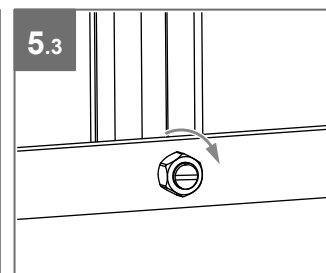
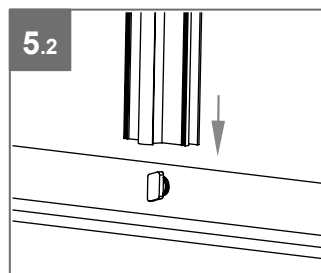
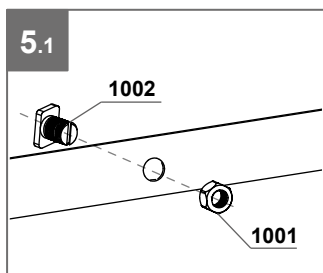
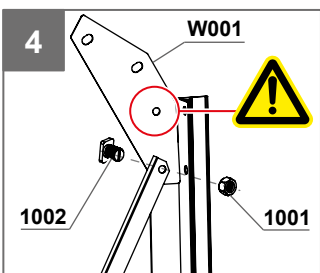
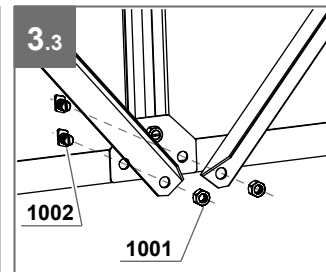
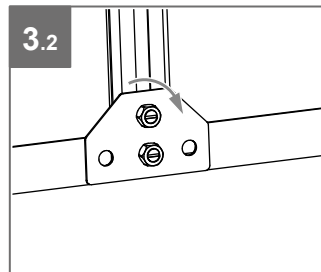
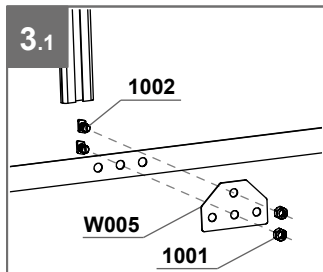
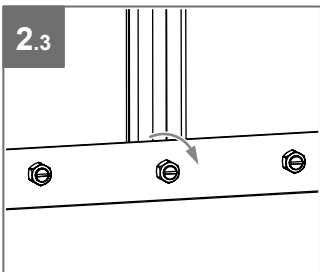
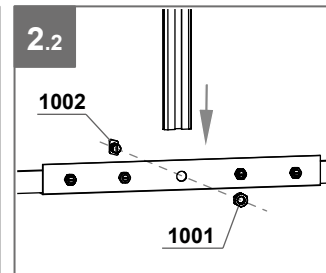
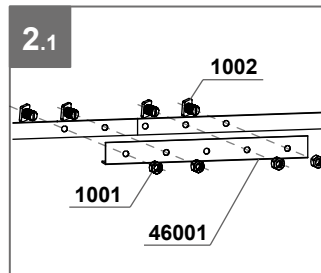
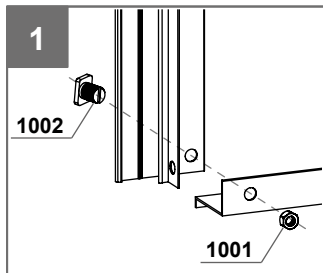

FACE ARRIÈRE (SANS PORTE) - RÜCKWAND (OHNE TÜR)

REAR WALL (WITHOUT DOOR)

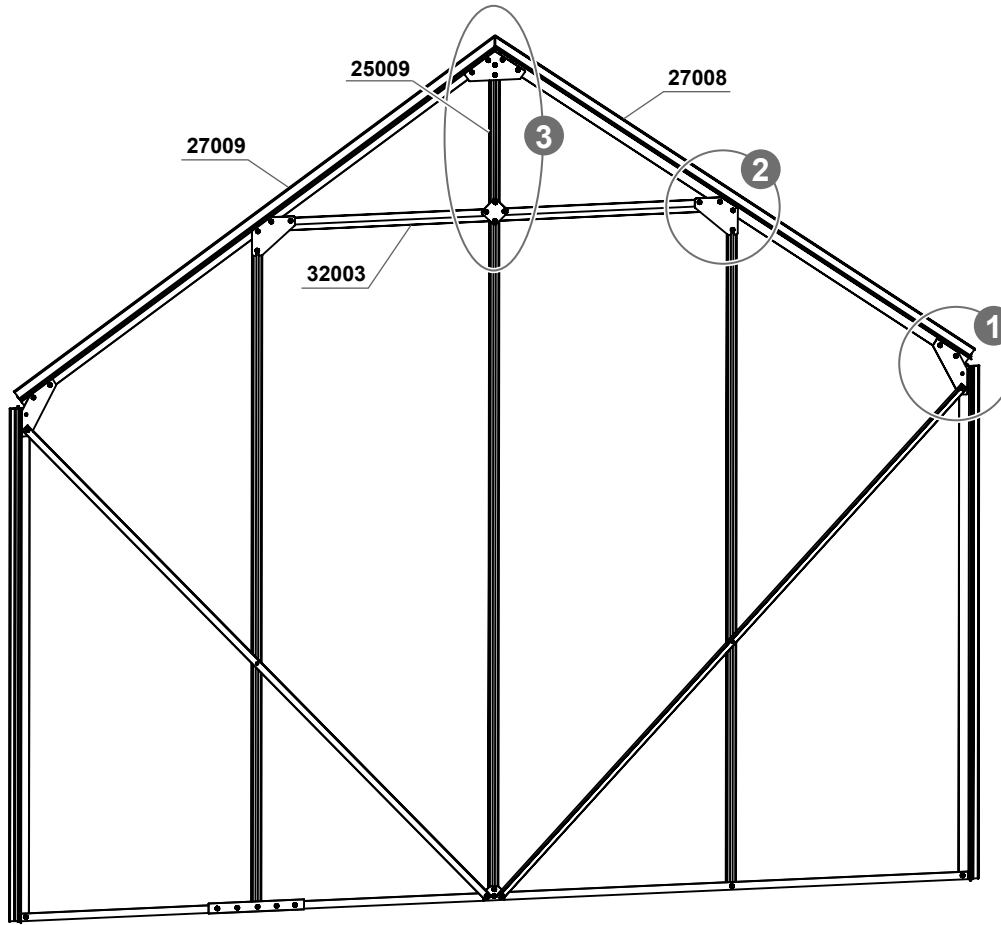

Module de base Basismodul Basic module

	25009 x 1
	27008 x 1
	27009 x 1
	32003 x 1
	W014 x 2
	W015 x 1
	W016 x 1
	1001 x 22
	1002 x 22

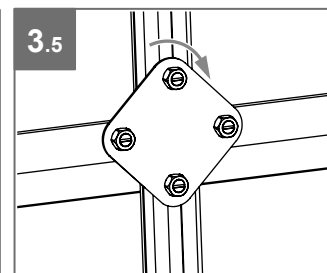
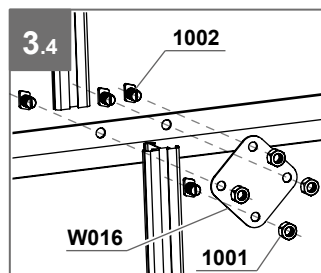
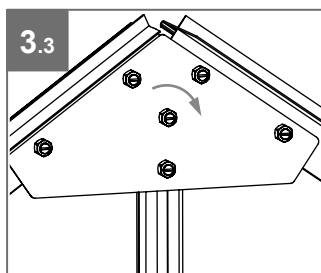
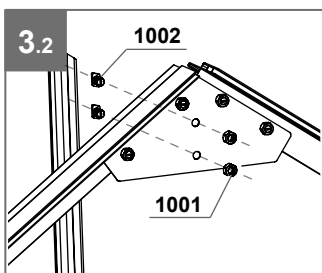
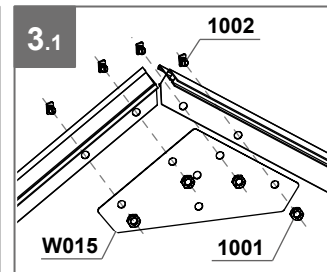
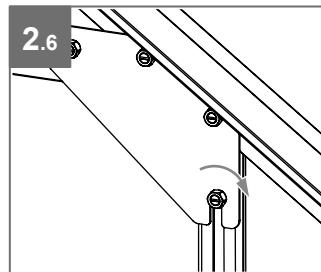
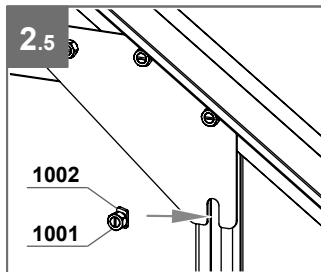
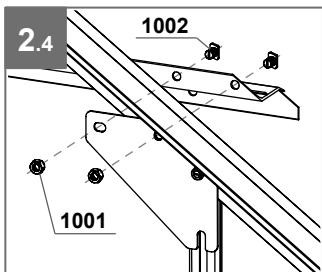
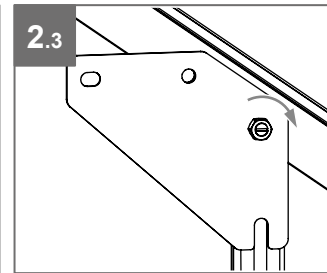
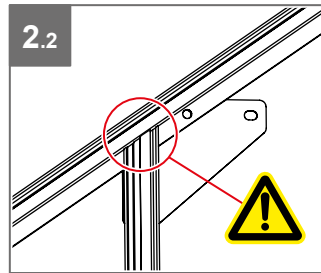
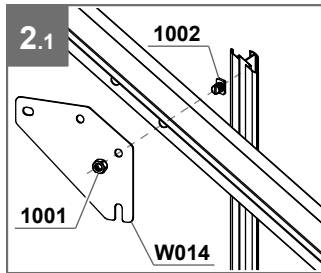
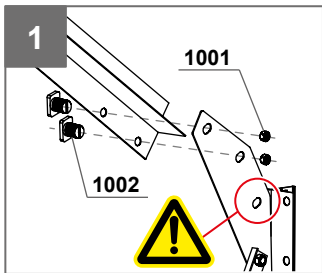

FACE ARRIÈRE (SANS PORTE) - RÜCKWAND (OHNE TÜR) REAR WALL (WITHOUT DOOR)

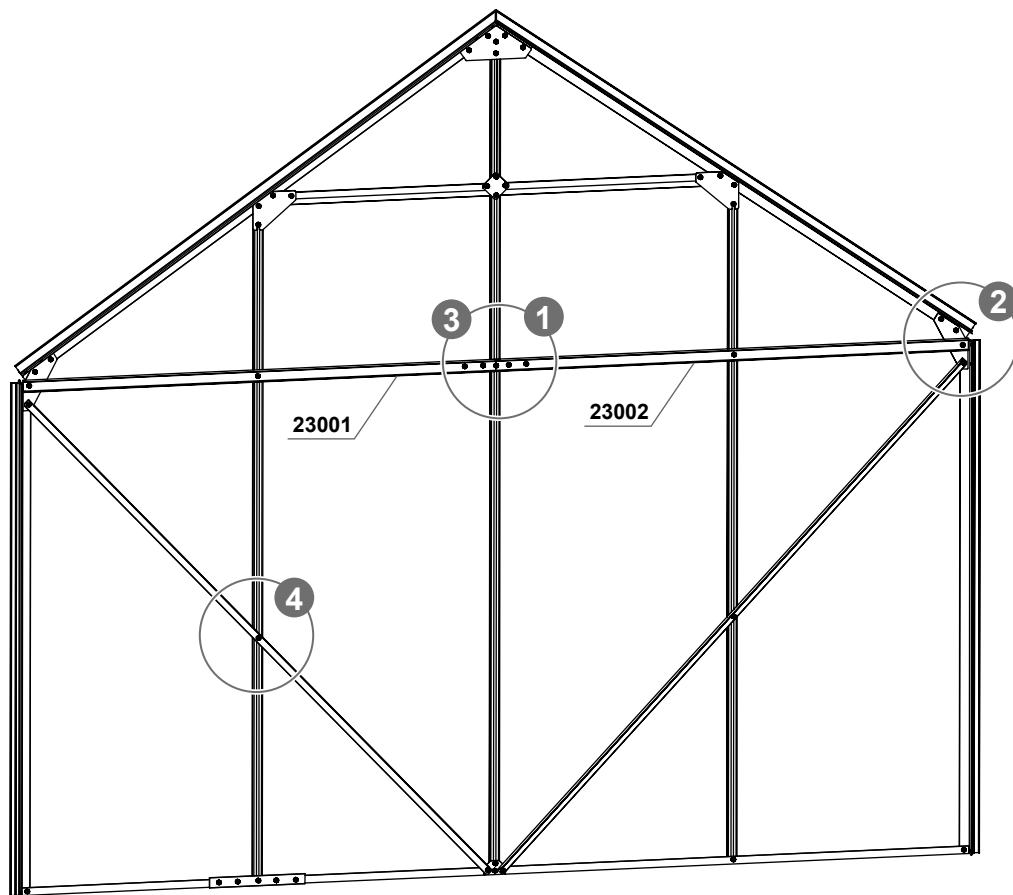

Module de base Basismodul Basic module

	23001 x 1
	23002 x 1
	46002 x 1
	1001 x 11
	1002 x 11

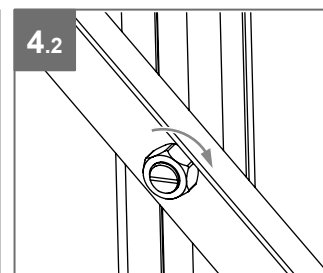
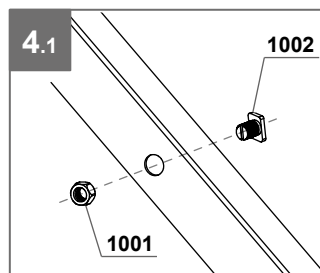
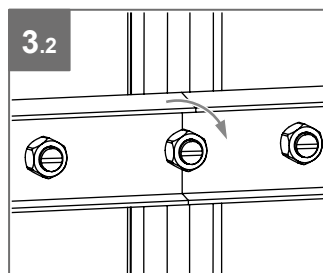
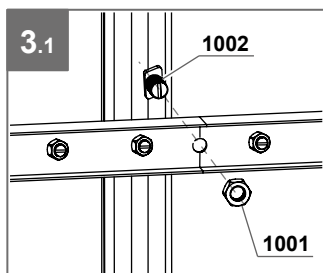
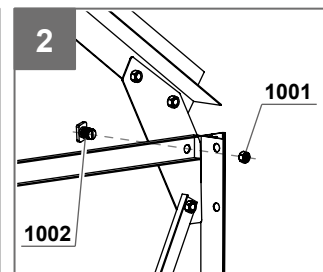
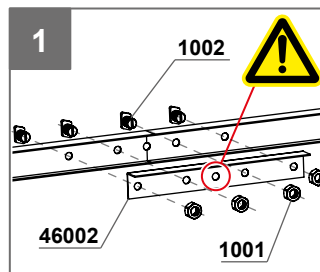

PORTE GAUCHE - LINKE TÜR LEFT DOOR

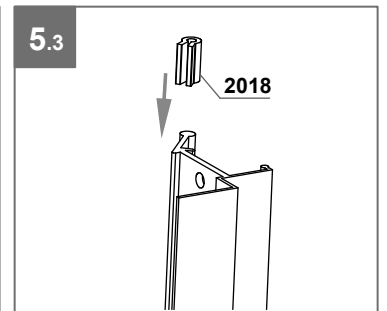
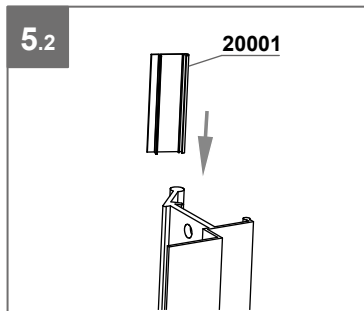
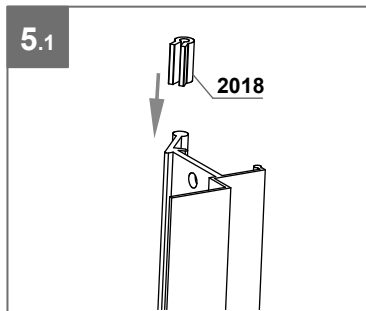
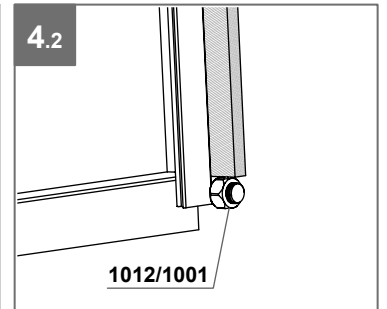
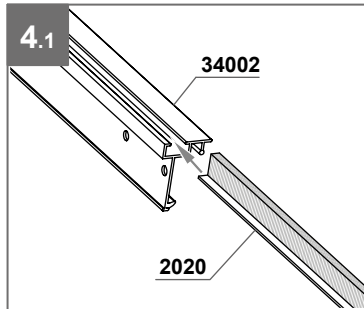
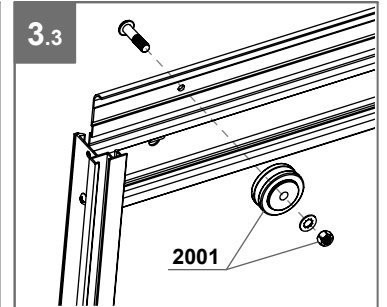
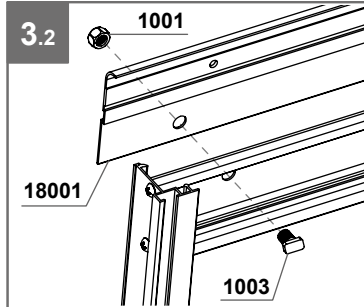
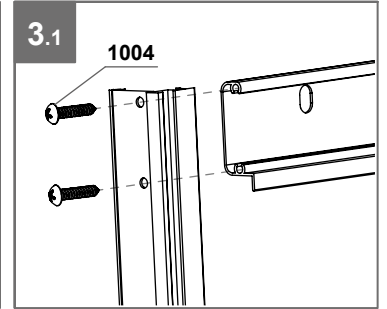
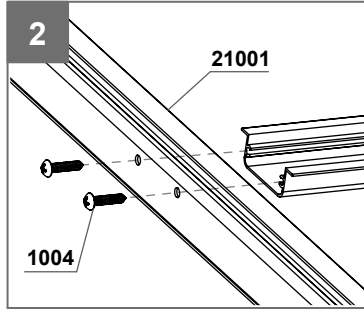
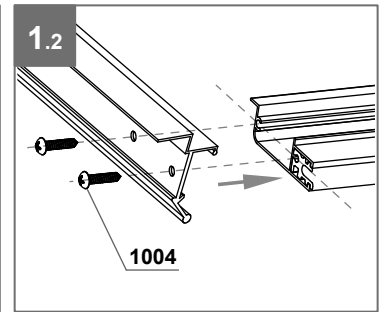
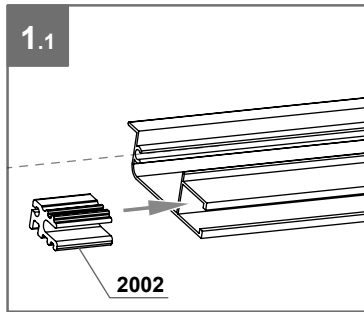
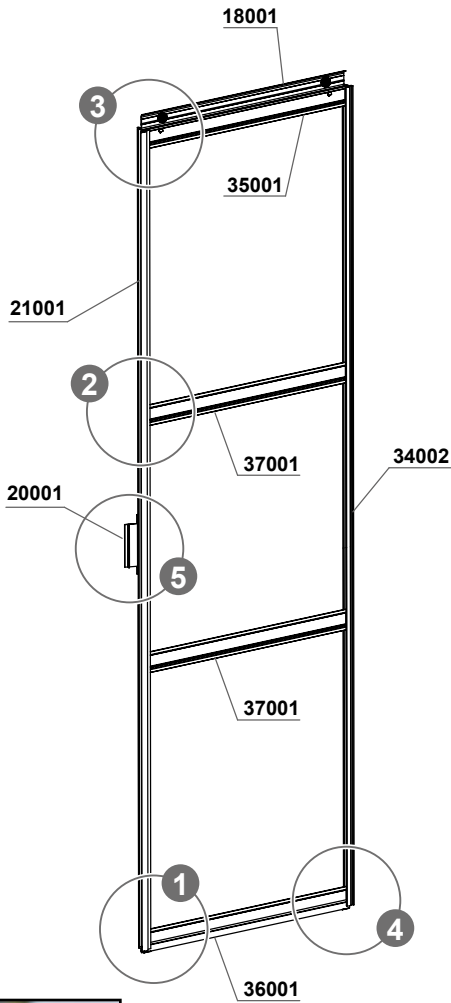

Module de base Basismodul Basic module

37001 x 2	2001 x 2	2002 x 2	18001 x 1	20001 x 1	21001 x 1	34002 x 1	35001 x 1	36001 x 1
2001 x 2	2002 x 2	2018 x 2	2020 x 1	1001 x 3	1003 x 2	1004 x 16	1012 x 1	1001 x 1

PORTE DROITE - RECHTE TÜR RIGHT DOOR

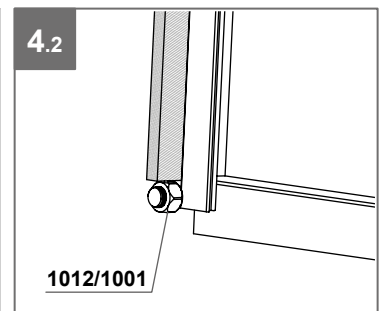
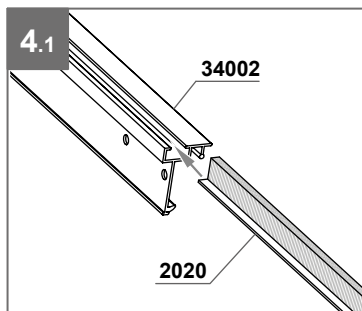
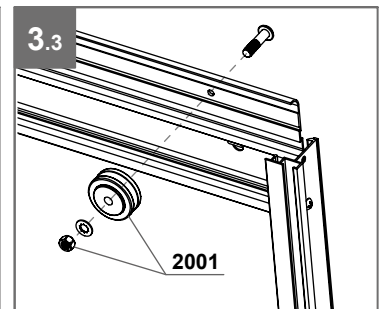
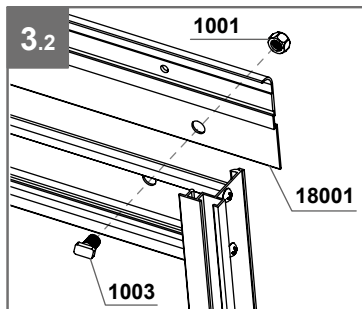
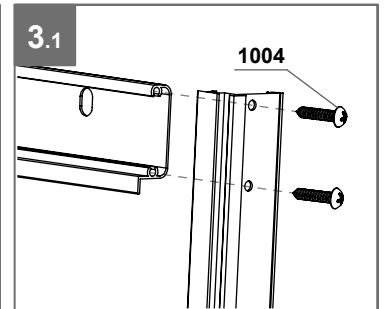
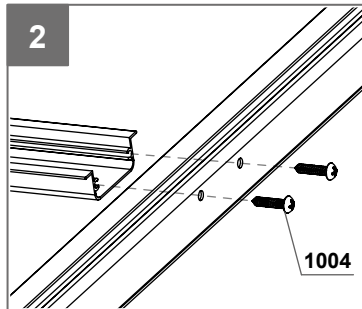
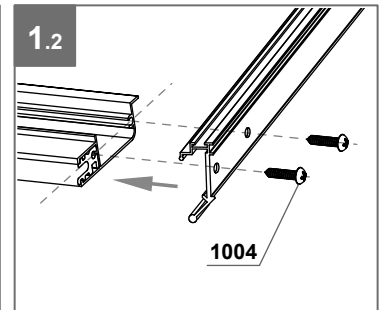
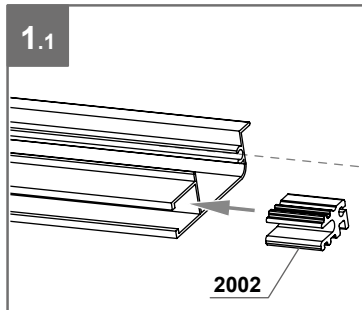
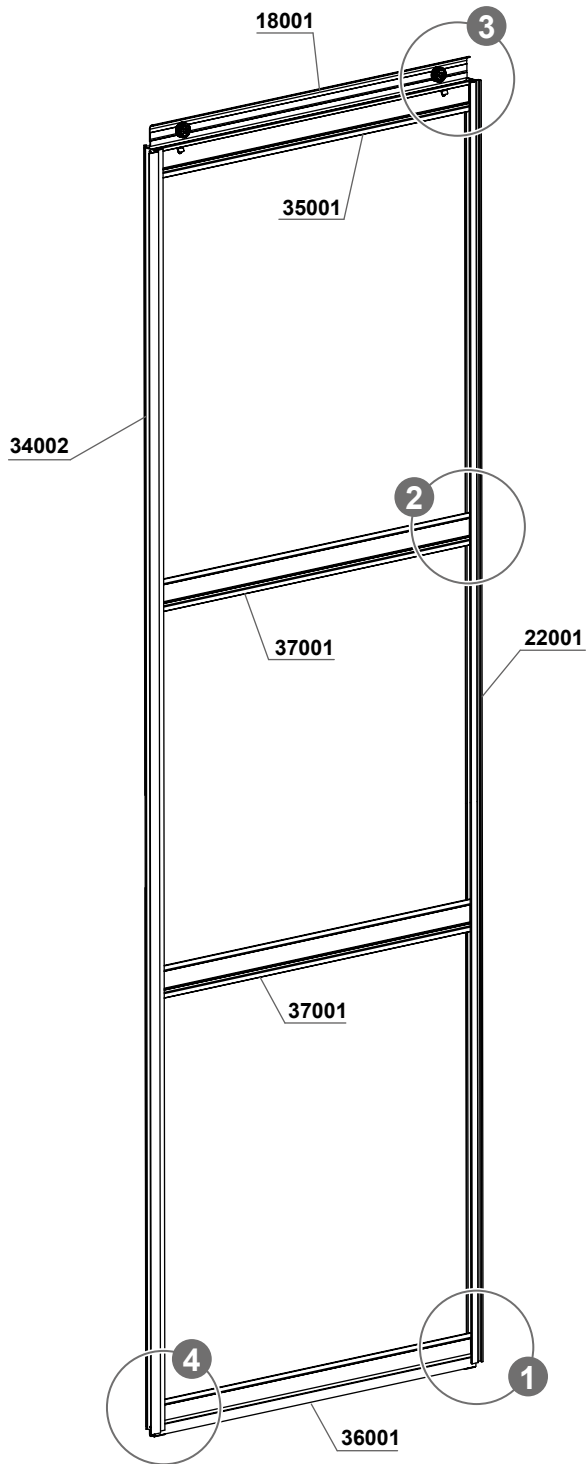

Module de base Basismodul Basic module

36001 x 1	37001 x 2	2001 x 2	2002 x 2	2020 x 1	18001 x 1	22001 x 1	34002 x 1	35001 x 1
1001 x 3	1003 x 2	1004 x 16	1012 x 1					

LUCARNE - FENSTER - WINDOW

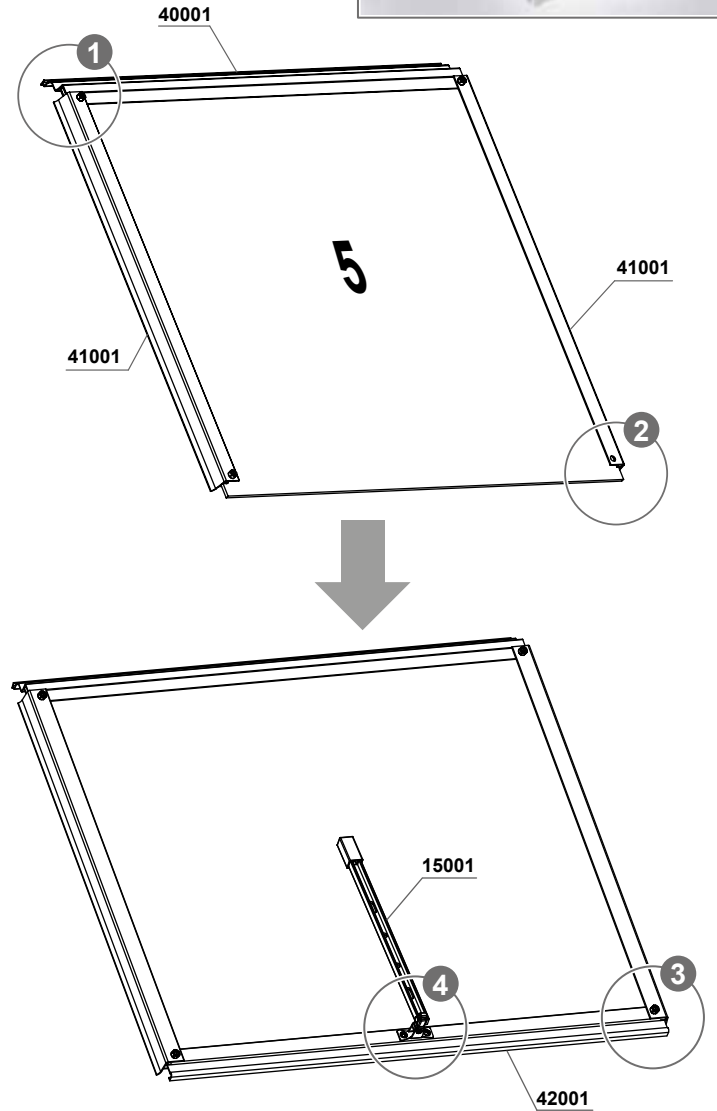
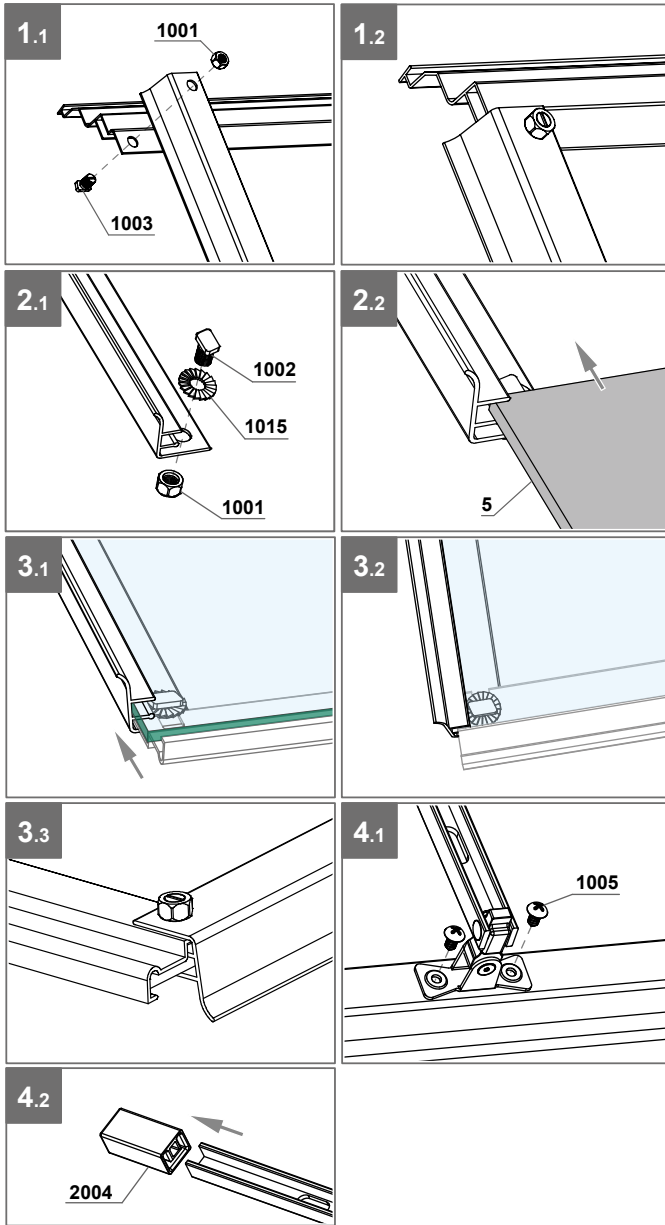

Module de base - Basismodul - Basic module

40001 x 4	41001 x 8	42001 x 4	2004 x 4	1001 x 16	1002 x 8	1003 x 8	1005 x 8	1015 x 8
600 x 544 mm								
5 x 4	15001 x 4							

Module d'extension - Erweiterungsmodul - Extension module

40001 x 2	41001 x 4	42001 x 2	2004 x 2	1001 x 8	1002 x 4	1003 x 4	1005 x 4	1015 x 4

	600 x 544 mm
15001 x 2	5 x 2

ASSEMBLAGE DES PAROIS - ZUSAMMENBAU DER WÄNDE

ASSEMBLY OF THE WALLS

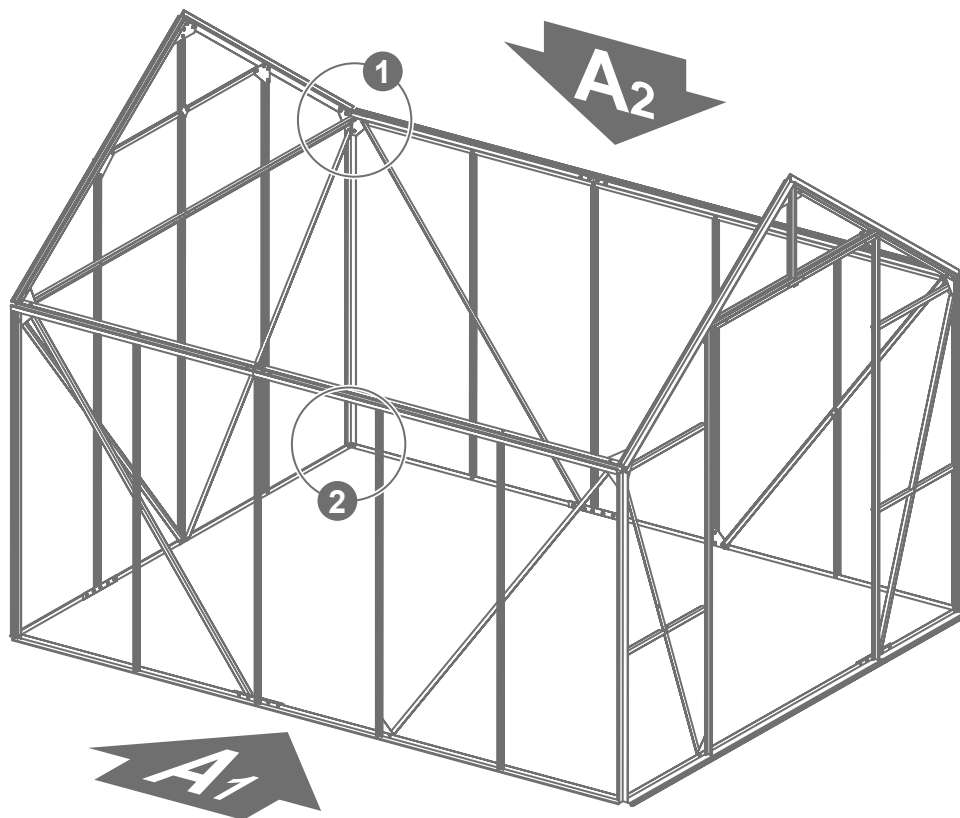

Module de base
Basismodul
Basic module

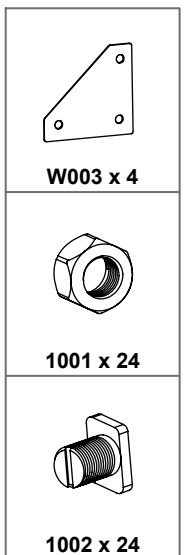
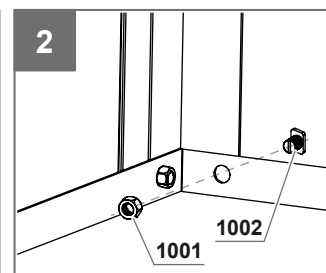
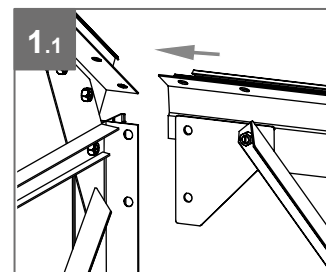
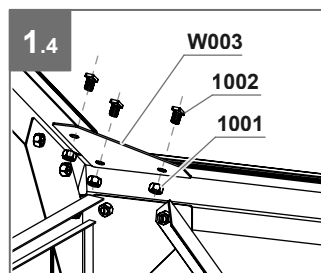
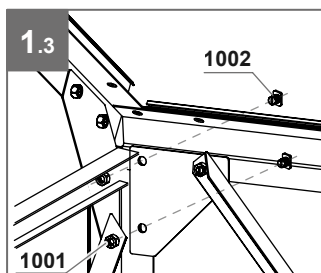
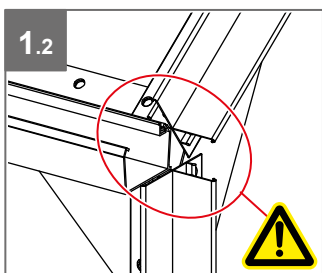



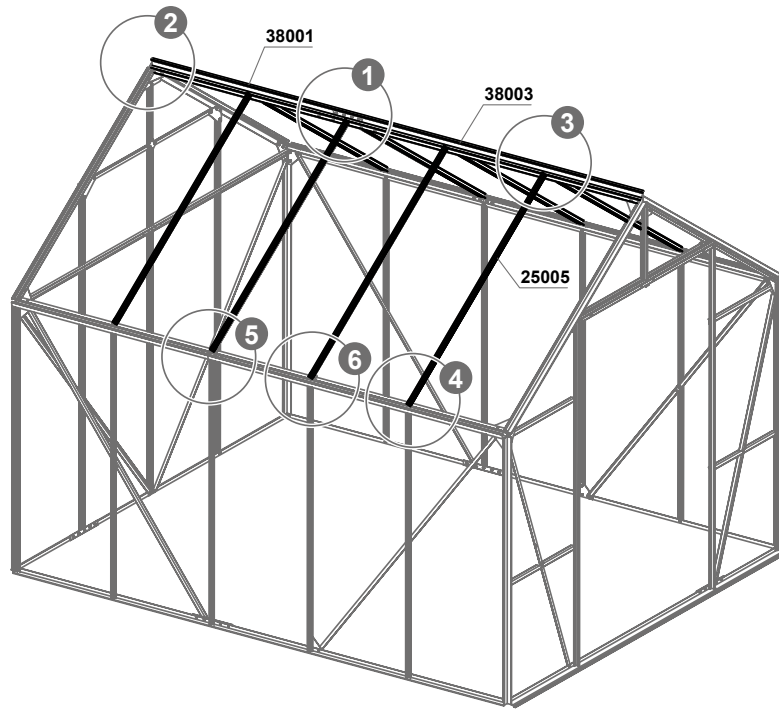

MONTAGE DES PROFILÉS DE TOITURE - MONTAGE DER DACHPROFILE ASSEMBLING THE ROOF PROFILES

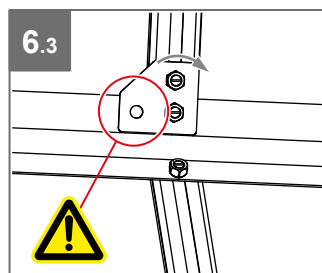
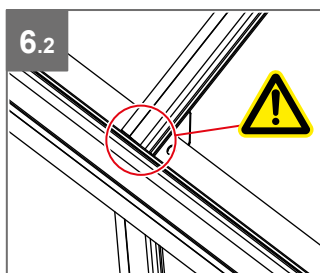
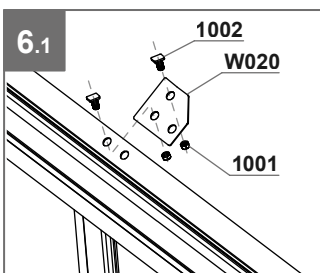
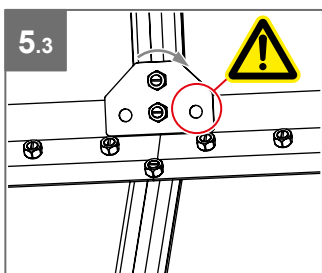
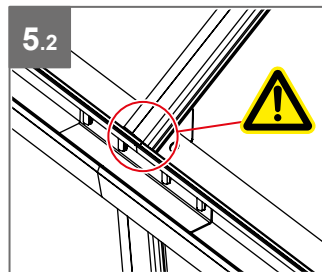
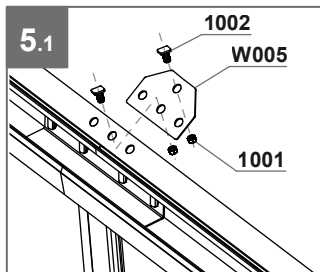
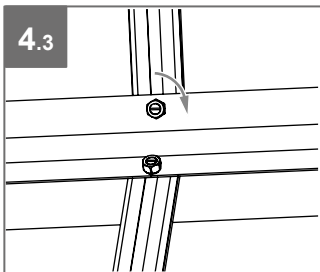
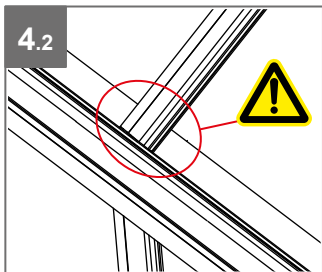
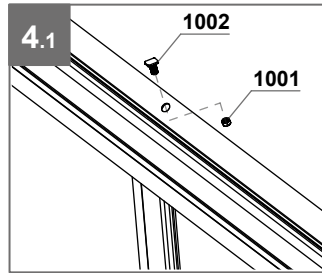
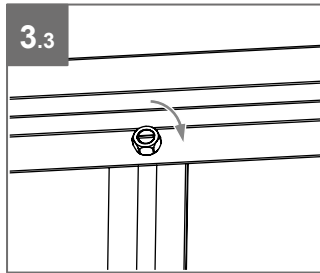
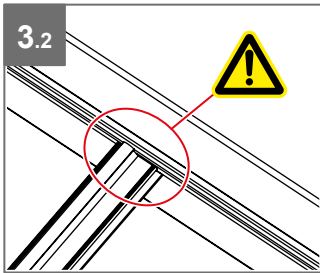
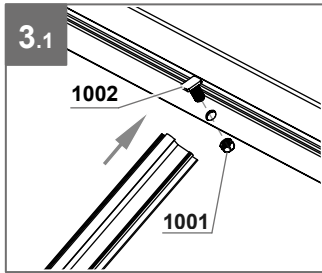
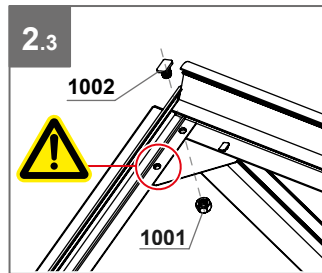
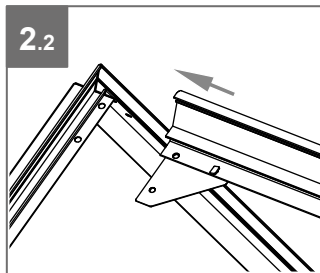
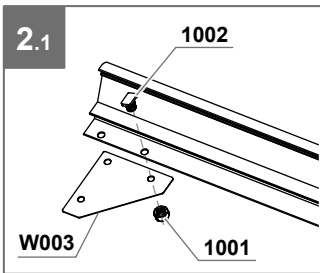
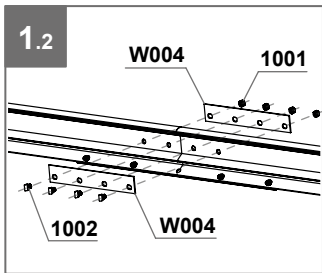
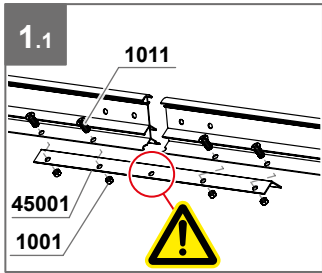

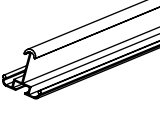
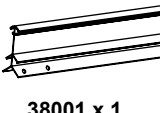
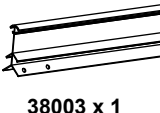
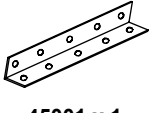
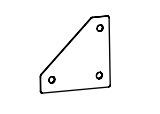
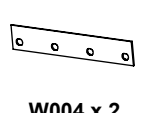
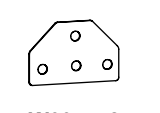
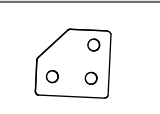
Module de base
Basismodul
Basic module

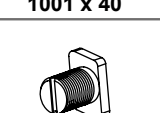

-  25005 x 8
-  38001 x 1
-  38003 x 1
-  45001 x 1
-  W003 x 4
-  W004 x 2
-  W005 x 2
-  W020 x 2
-  1001 x 40
-  1002 x 32
-  1011 x 8

MONTAGE DES TENDEURS ET GOUSSETS SPANNVORRICHTUNG UND VERBINDER WIND BRACES AND GUSSETS

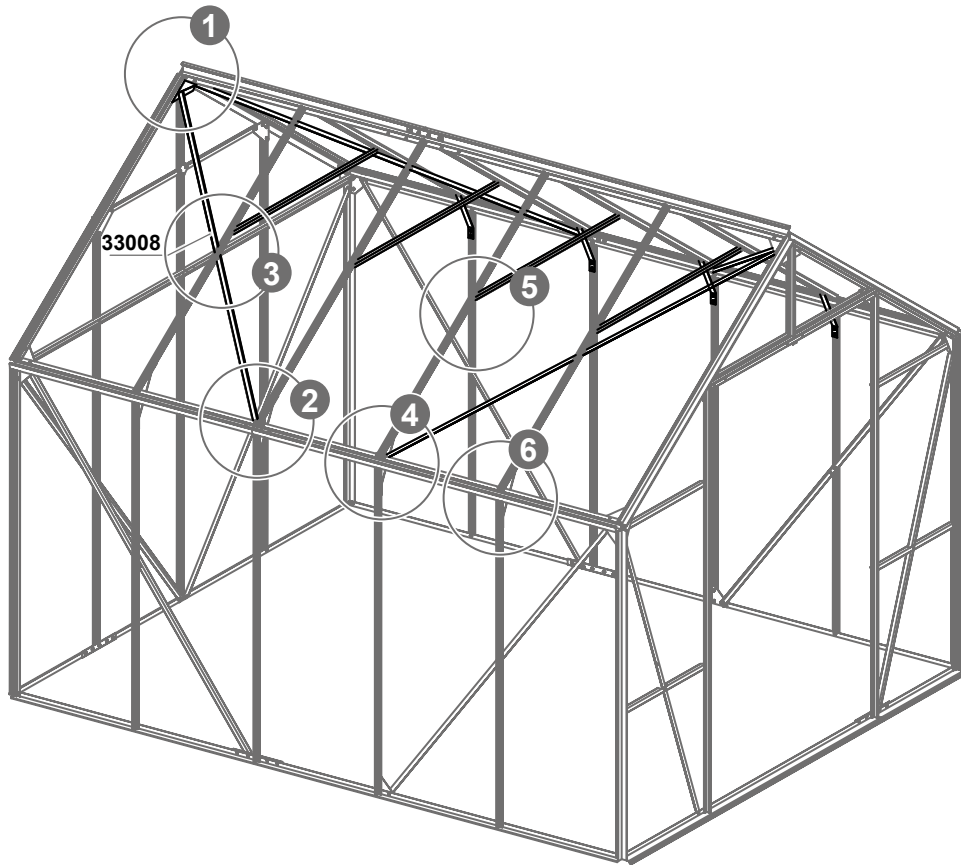

Module de base
Basismodul
Basic module

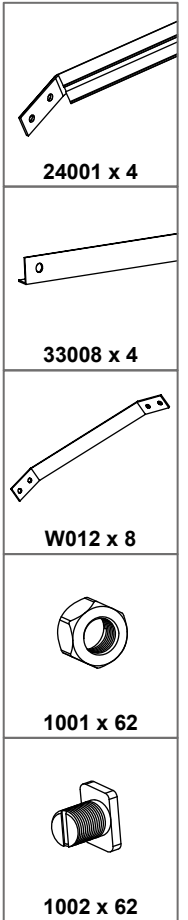
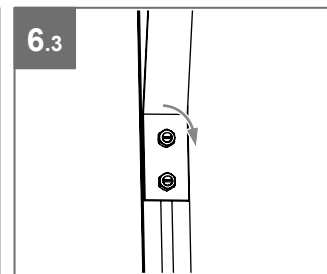
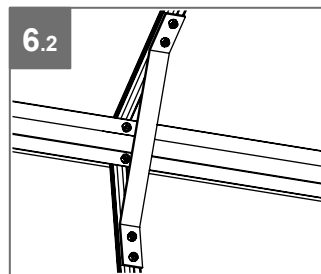
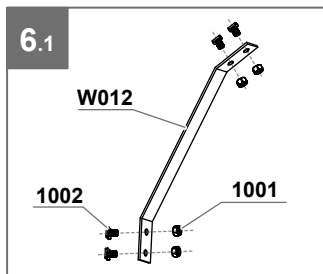
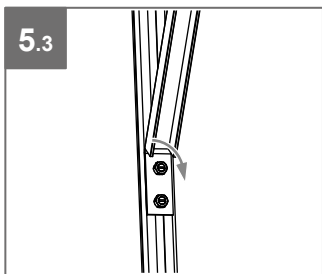
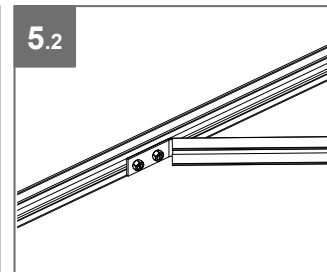
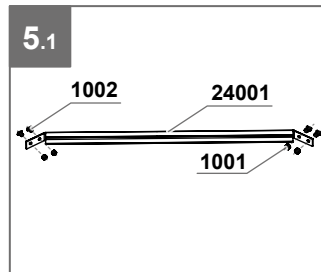
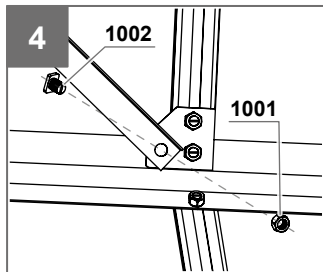
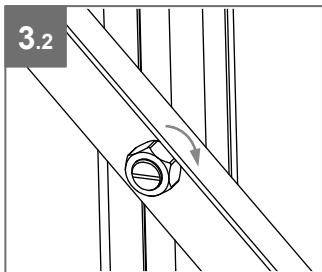
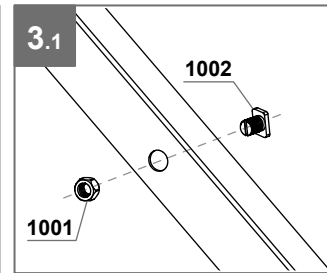
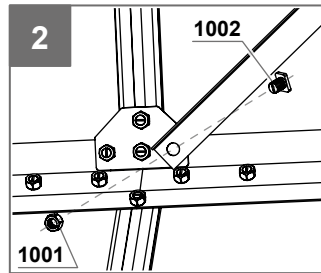
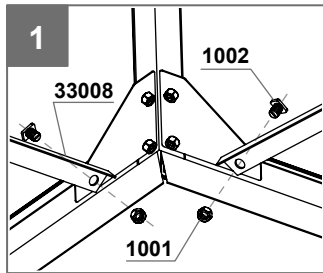

FIXATION DE LA SERRE SUR LA BASE

BEFESTIGUNG DES GEWÄCHSHAUSES AM FUNDAMENTRAHMEN

FASTENING THE GREENHOUSE ONTO THE GREENHOUSE BASE

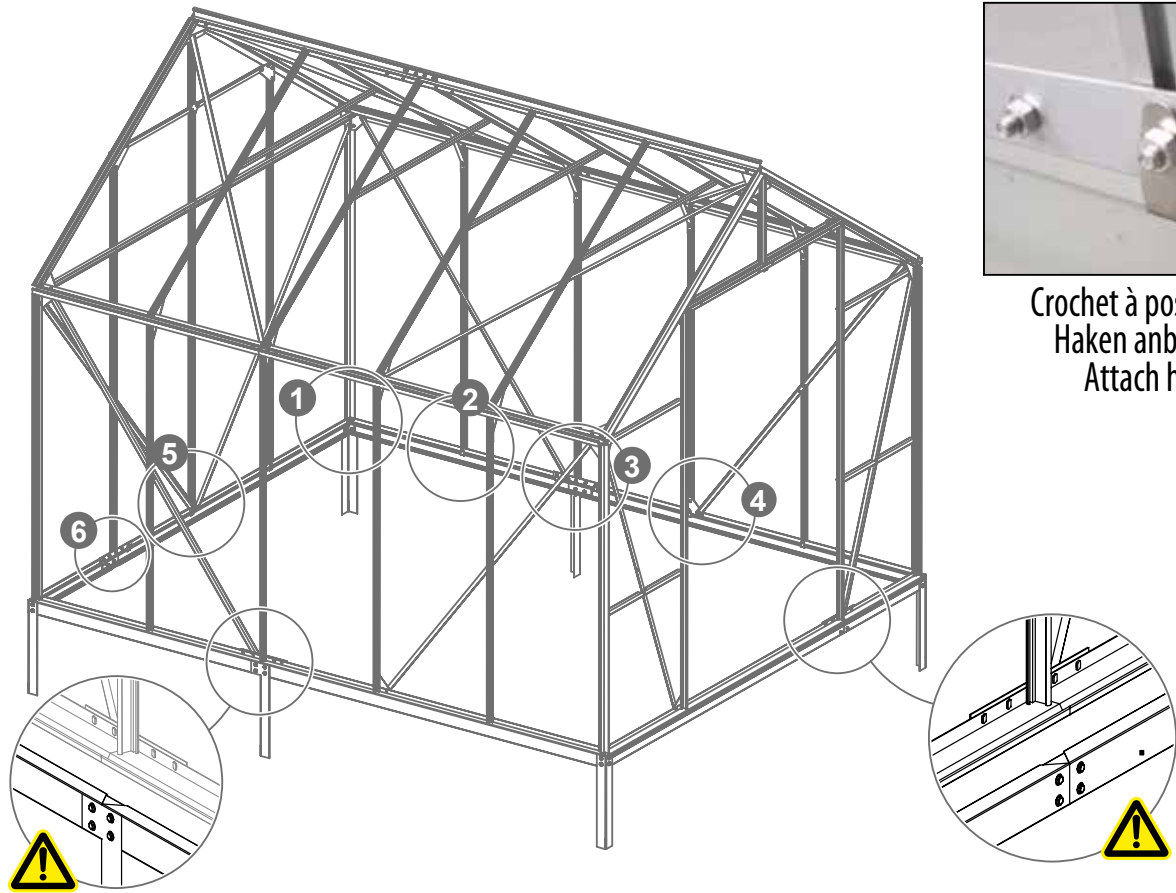

Crochet à positionner
Haken anbringen
Attach hook

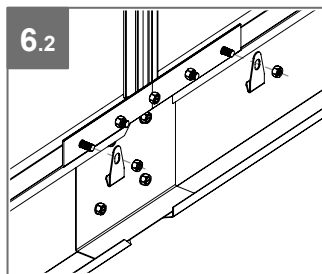
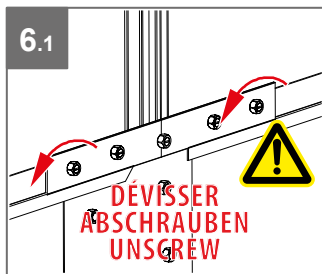
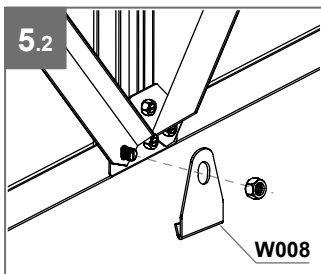
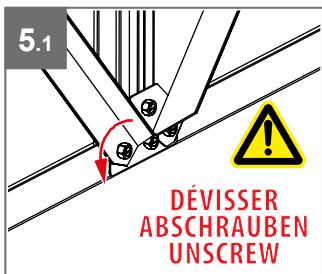
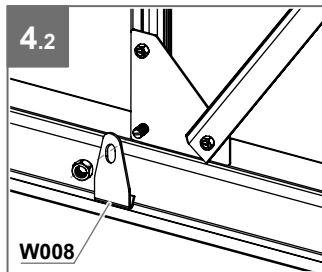
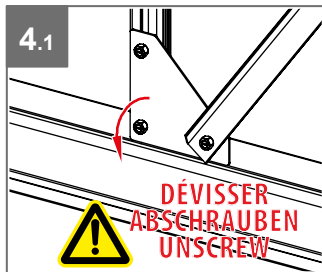
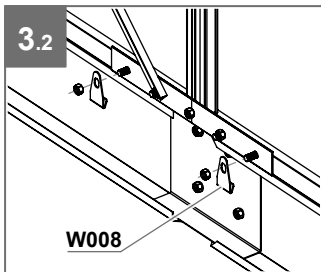
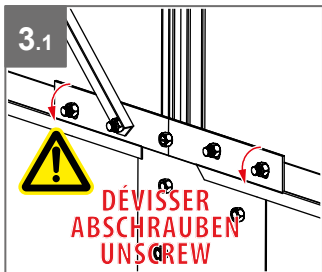
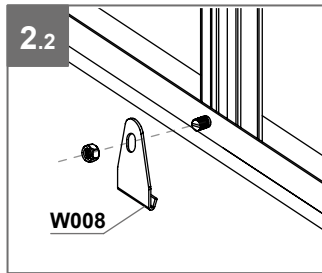
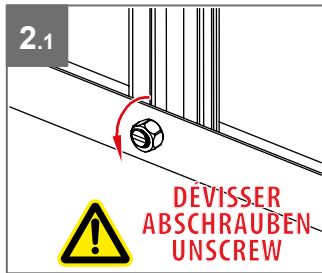
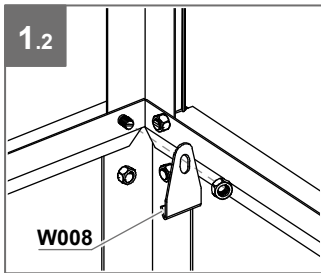
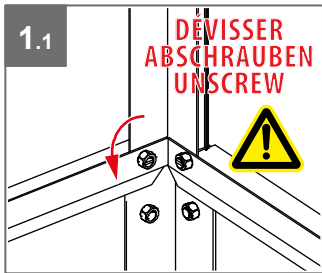

Module de base
Basismodul
Basic module

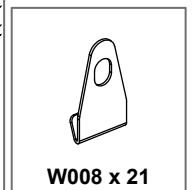

MONTAGE PORTE + RAIL MONTAGE TÜR + SCHIENE ASSEMBLING DOOR + RAIL

Recommandation : graissage régulier du rail
Empfehlung : regelmäßig schmieren
Recommendation : grease regularly



Rail de porte - Schiene - Rail



Haut de porte
Oberer Türbereich
Upper door area

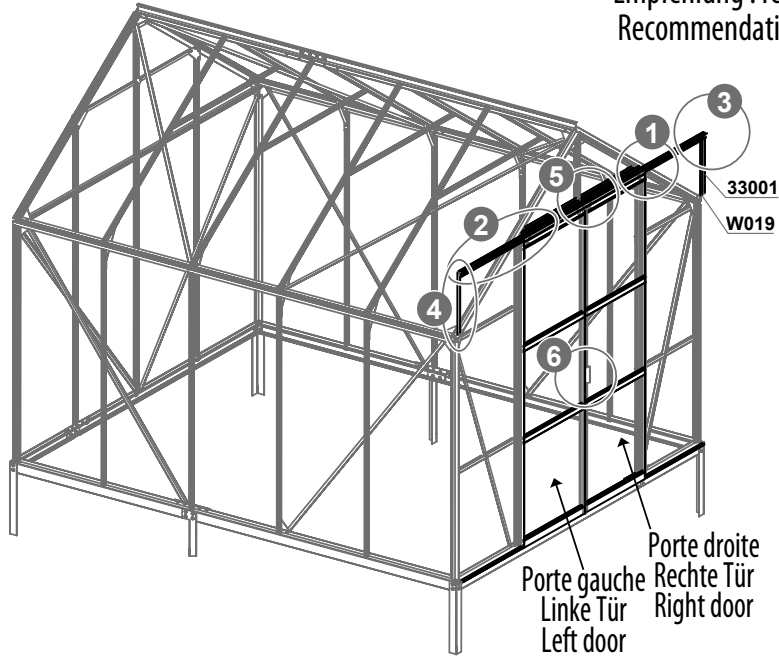

Module de base Basismodul Basic module

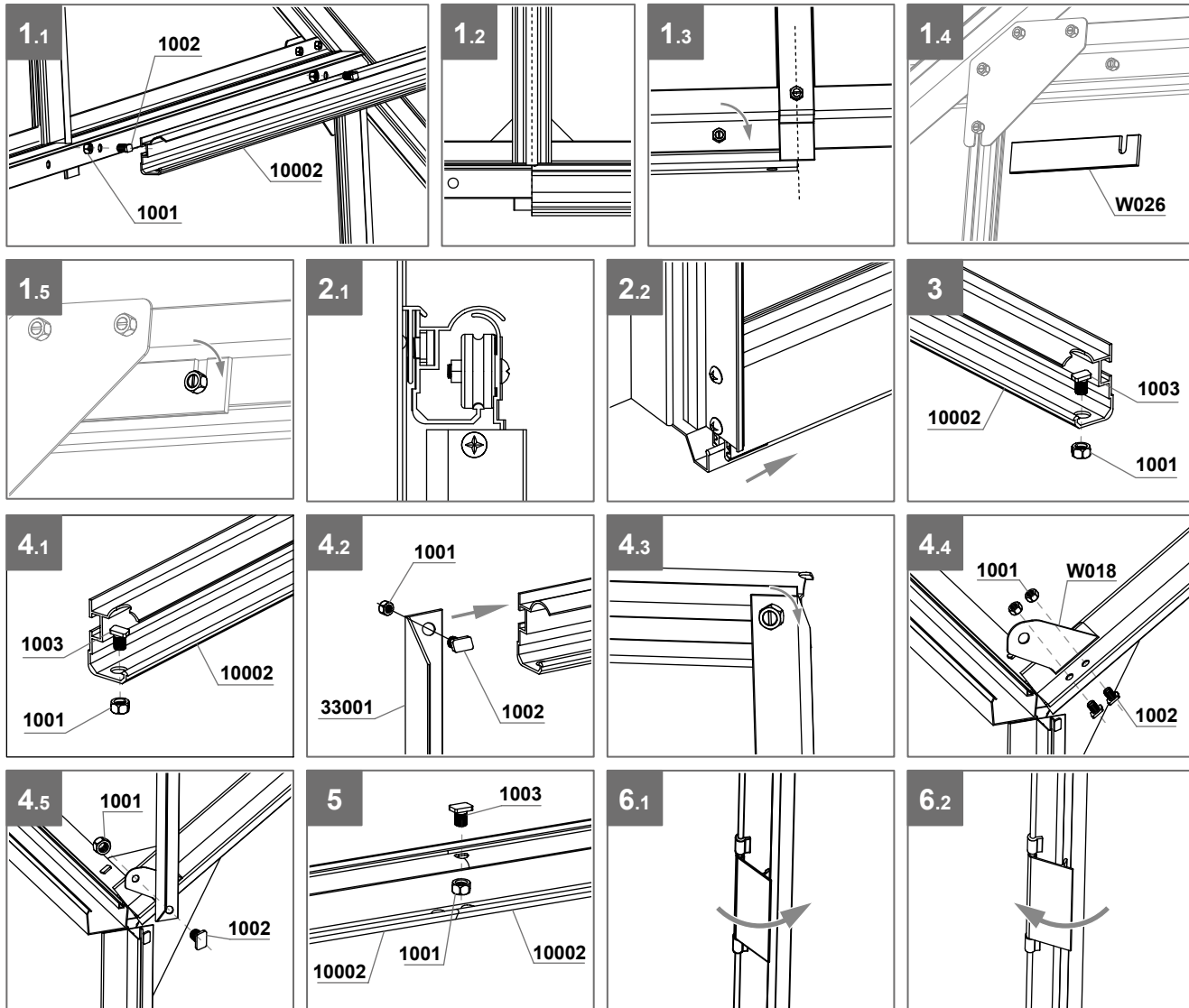

	10002 x 2
	33001 x 2
	W026
	W018 x 1
	W019 x 1
	1001 x 15
	1002 x 12 1003 x 3
	W026 x 2

POSE DU JOINT DE VITRAGE VERGLASUNGSDICHTUNG ANBRINGEN INSTALLING THE GLAZING SEAL

Le joint caoutchouc est à poser sur les profilés de toiture, parois et porte.
Die Gummidichtung ist auf allen Dach-, Wand- und Türprofile anzubringen.
The rubber seal is to be attached on all the roof, wall and door profiles.

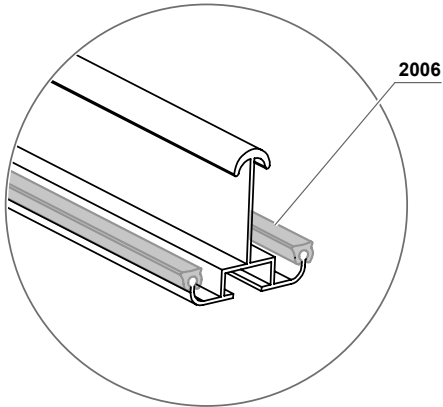

Module de base
Basismodul
Basic module

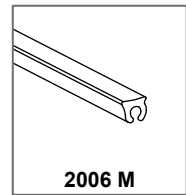

VITRAGE - VERGLASUNG - GLAZING

Nous vous conseillons d'installer les verres niveau par niveau (du bas vers le haut).



Wir empfehlen Ihnen, die Gläser Ebene für Ebene anzubringen (von unten nach oben).

We advise you to install the glazing level by level (from bottom to top).



Crochets de vitrage
Verglasungshaken
Glazing hooks



Clips de vitrage
Gewächshausklammern
Glazing clips

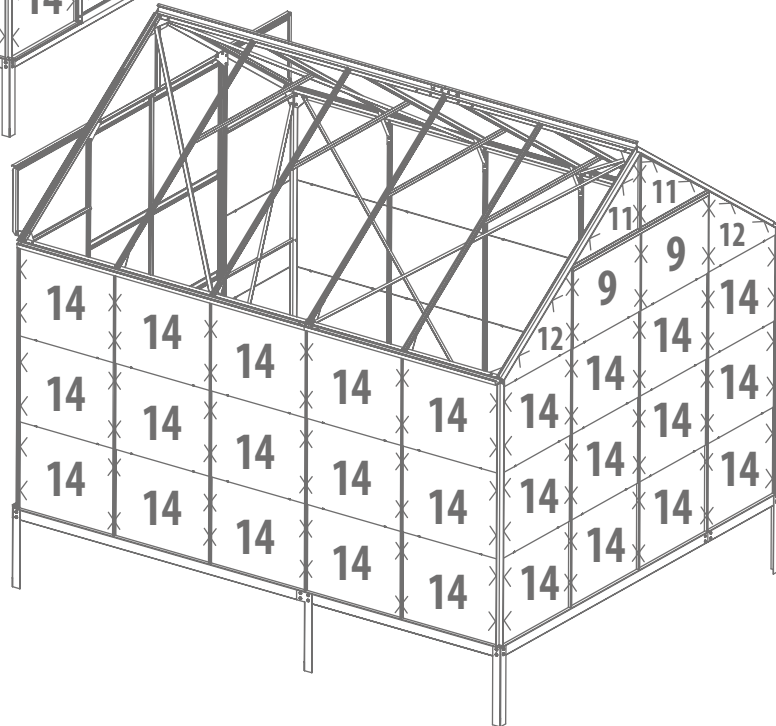
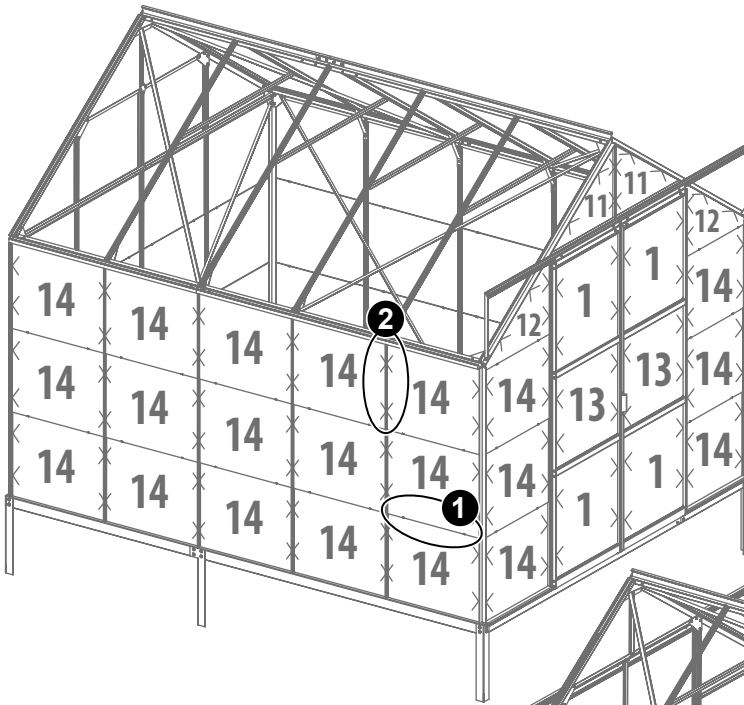

Module de base Basismodul Basic module

610 x 610	
1 x 4	
610 x 461	
9 x 2	
610 x 434/8	
11 x 4	
610 x 468/44	
12 x 4	
610 x 540	
13 x 2	
610 x 509	
14 x 48	
W006 x 76	
W007 x 256	

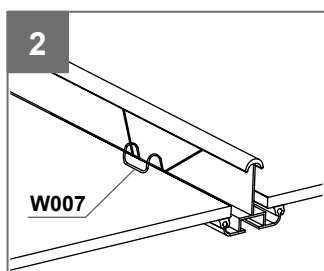
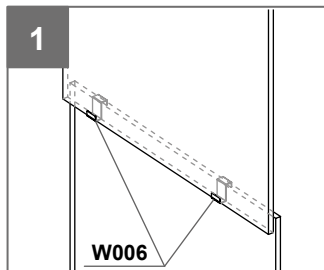

Il peut être nécessaire de dévisser temporairement certains profilés pour la mise en place des verres.

Resserer correctement les vis après la pose des verres.

Zum Anbringen der Gläser kann es erforderlich sein, bestimmte Profile vorübergehend abzuschrauben. Schrauben Sie diese nach der Anbringung der Gläser wieder fest.

Some profiles may need to be temporarily unscrewed to install the glazing. Refix the screws correctly after installing the glazing.

VITRAGE + POSE LUCARNE

VERGLASUNG + FENSTER EINBAUEN

GLAZING + INSTALLING WINDOW



Lucarne - vue extérieure
 Fenster - Außenansicht
 Window - exterior view



1
 Pose de la lucarne sur faîtière
 par glissement.
 Anbringung des Fensters auf
 First durch Gleiten.
 Installing the window on
 roof ridge through sliding.

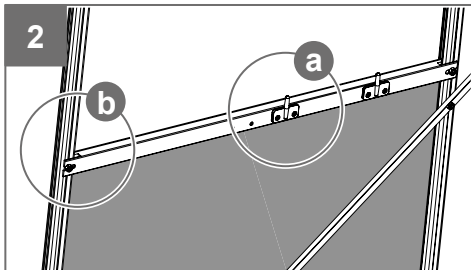
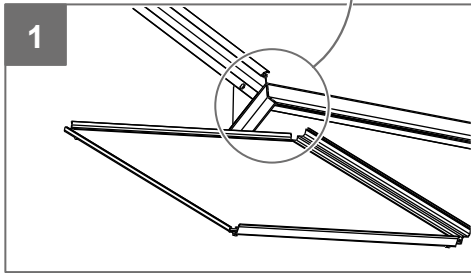
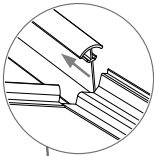

b.1
 Couper le joint pour
 passage de la pièce 39001

Dichtung schneiden um Einzelteil 39001 durchzulassen
 Cut the seal to let part 39001 through

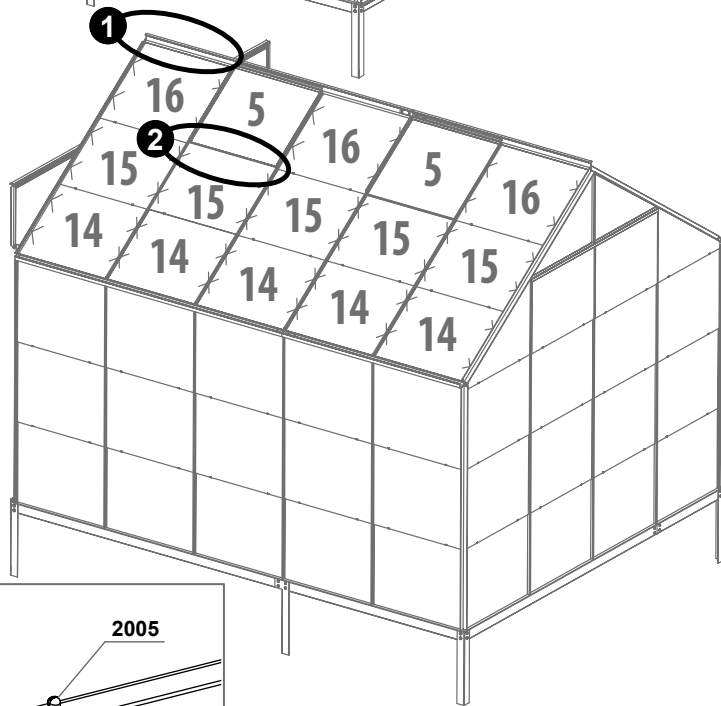
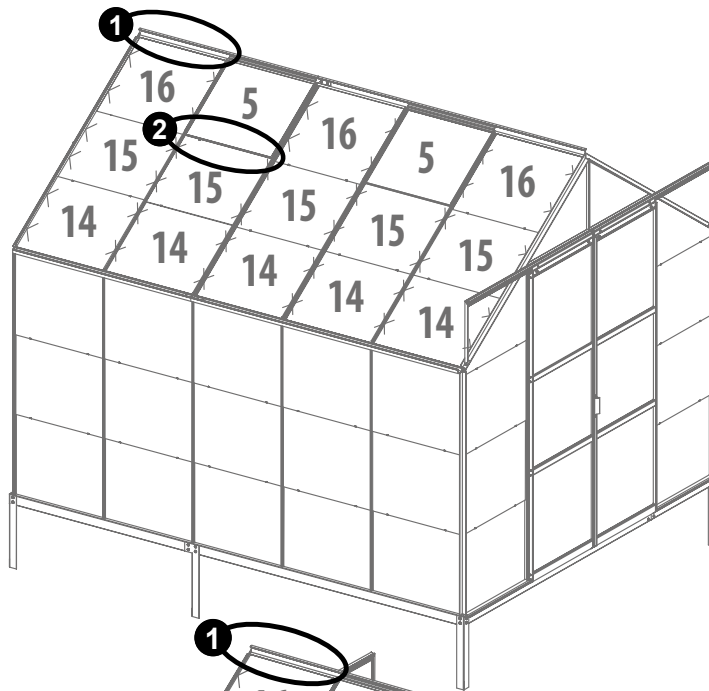
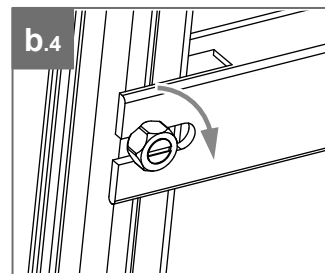
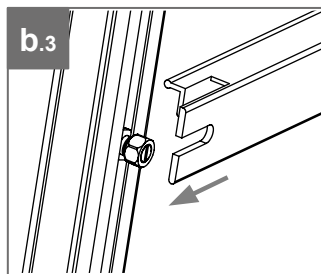
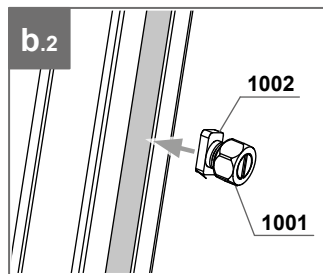

Module de base Basismodul Basic module

610 x 509



14 x 10

610 x 487



15 x 10

610 x 549



16 x 6

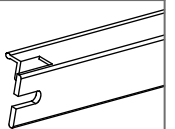

39001 x 4



1001 x 8



1002 x 8



1005 x 16



2005 x 8



W006 x 32



W007 x 104

MONTAGE DES PIÈCES PLASTIQUES

MONTAGE DER KUNSTSTOFFTEILE

INSTALLING THE PLASTIC PARTS



Détail embout de faîtière (pièce 2010)
 Abdeckung der Firstspitze (Einzelteil 2010)
 Roof ridge end cover (part 2010)

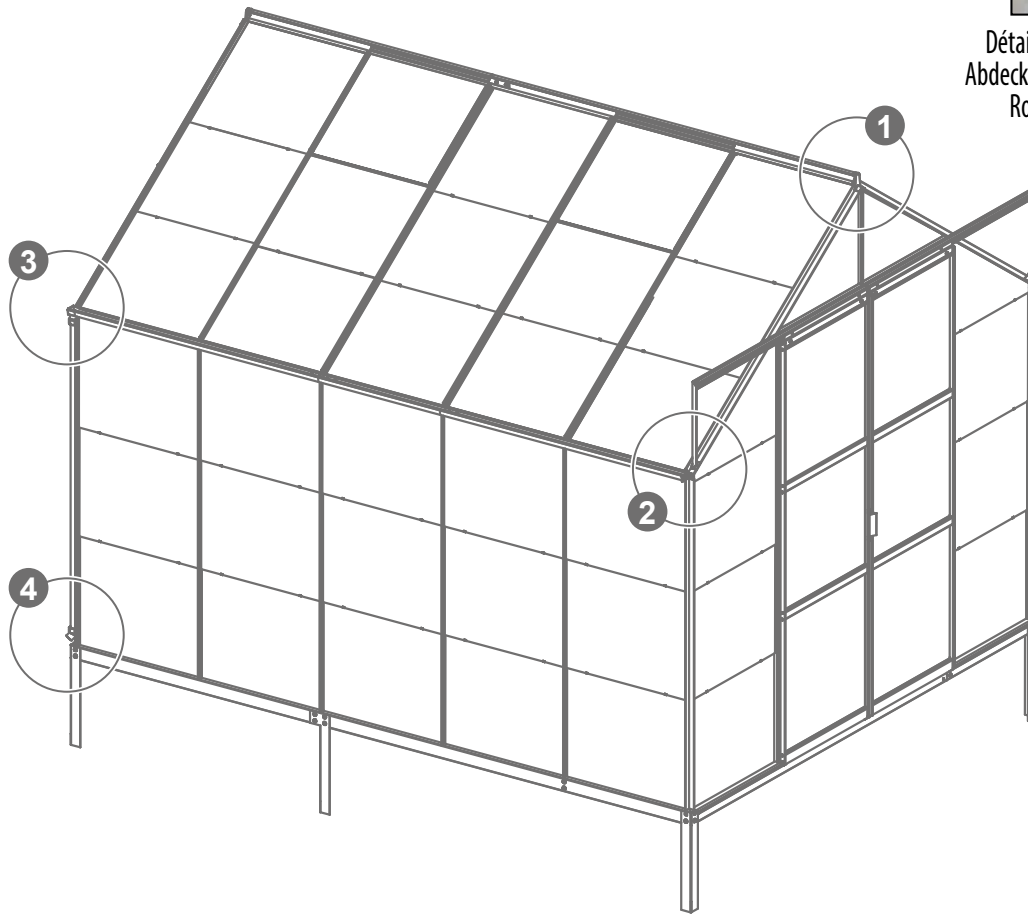

Module de base Basismodul Basic module

	1005 x 4
	2010 x 2
	2022 x 2
	2023 x 2
	2028 x 2
	2032 x 2
	2034 x 2
	58001 x 4

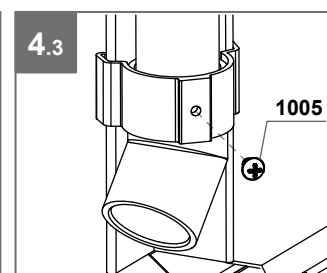
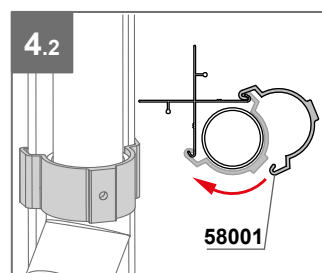
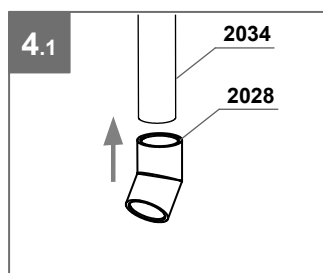
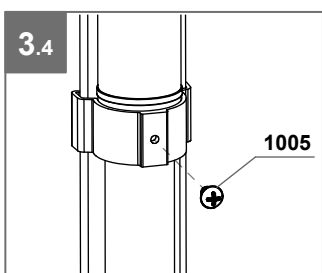
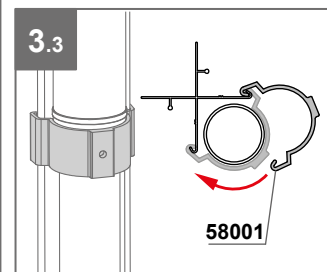
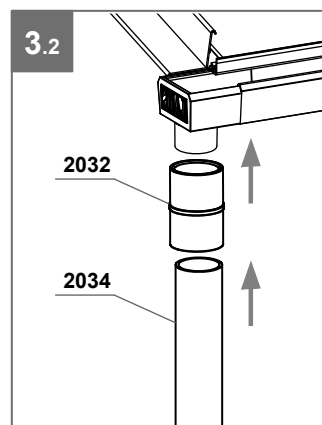
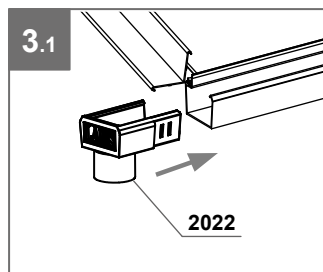
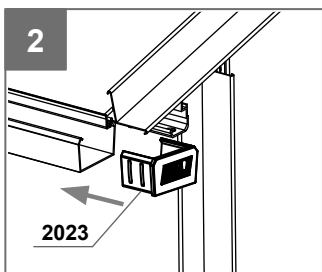
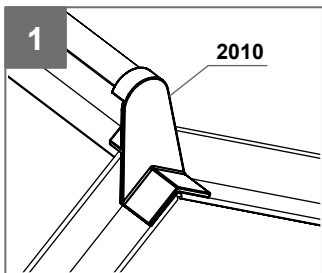

SERRE - GEWÄCHSHAUS - GREENHOUSE

LAURUS **11,30 M²**

Module de base 8,10 m² + module d'extension 3,20 m²

Basismodul 8,10 m² + Erweiterungsmodul 3,20 m²











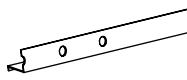
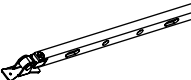
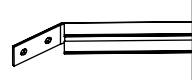

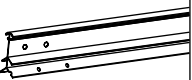
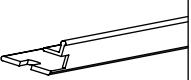



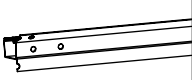
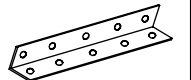
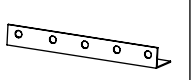



Basic modul 8,10 m² + extension module 3,20 m²

NOMENCLATURE EXTENSION - STÜCKLISTE ERWEITERUNG

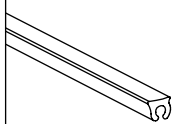
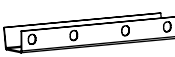
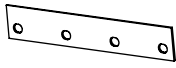
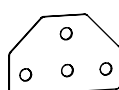
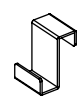
BILL OF MATERIALS EXTENSION

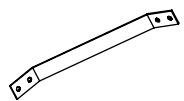
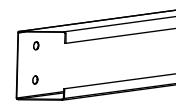
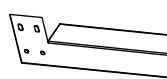
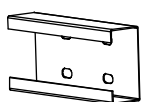

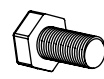



Colis - Paket - Parcel

1/2

PROFILÉS ALUMINIUM - ALUMINIUMPROFILE - ALUMINIUM PROFILES						
01006 x 2  L:1244 mm	15001 x 2  L:270 mm	24001 x 2  L:1160 mm	25005 x 8  L:1511 mm	38002 x 1  L:1244 mm	39001 x 2  L:634 mm	40001 x 2  L:602 mm
41001 x 4  L:518 mm	42001 x 2  L:602 mm	43003 x 2  L:1244 mm	45001 x 1  L:400 mm	46001 x 2  L:250 mm		
PETITS COMPOSANTS - KLEINTEILE - SMALL COMPONENTS						
1001 x 86  M6	1002 x 74 (M6 x 12 mm)  1003 x 4 (M6 x 8 mm)	1005 x 12  M3.5 x 6 mm	1011 x 8  M6 x 14 mm	1015 x 4  Ø 6	2004 x 2 	2005 x 4 
2006 x 24m 	W002 x 2 	W004 x 2 	W005 x 2 	W006 x 28 	W007 x 88 	W012 x 4 
BASE ET VISSERIE - FUNDAMENTRAHMEN UND SCHRAUBEN - GREENHOUSE BASE AND SCREWS						
D010 x 2  1245x60x30 mm	D012 x 2 	D014 x 2 	1008 x 8  Ø 6	1009 x 8 	1010 x 8 	W008 x 6 

Colis - Paket - Parcel

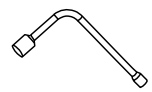
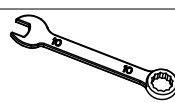
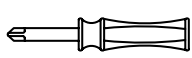
2/2

VERRES - GLÄSER - GLAZING						
5 x 2  600 x 544 mm	14 x 16  610 x 509 mm	15 x 4  610 x 487 mm	16 x 2  610 x 549 mm			
OUTILS INCLUS VORHANDENES WERKZEUG TOOLS INCLUDED		NON INCLUS NICHT VORHANDEN NOT INCLUDED				
 M6/10 mm	 M6/10 mm		 10 m			

MONTAGE BASE - MONTAGE FUNDAMENTRAHMEN - BASE ASSEMBLING

Il est impératif que la base soit montée de niveau.



Es ist zwingend erforderlich, dass der Fundamentrahmen auf einem ebenen Untergrund montiert wird.

It is imperative that the greenhouse base is leveled.

Module de base
Basismodul
Basic module

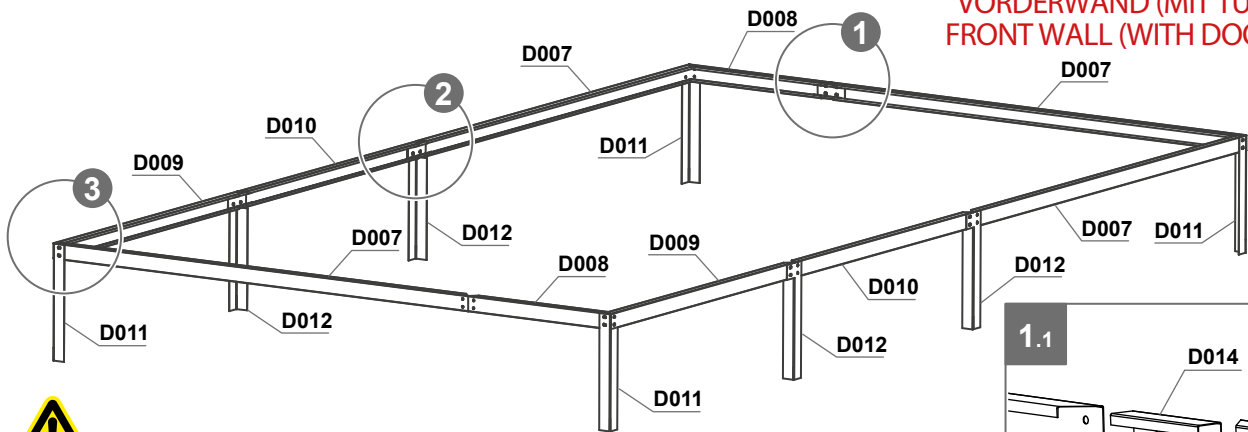
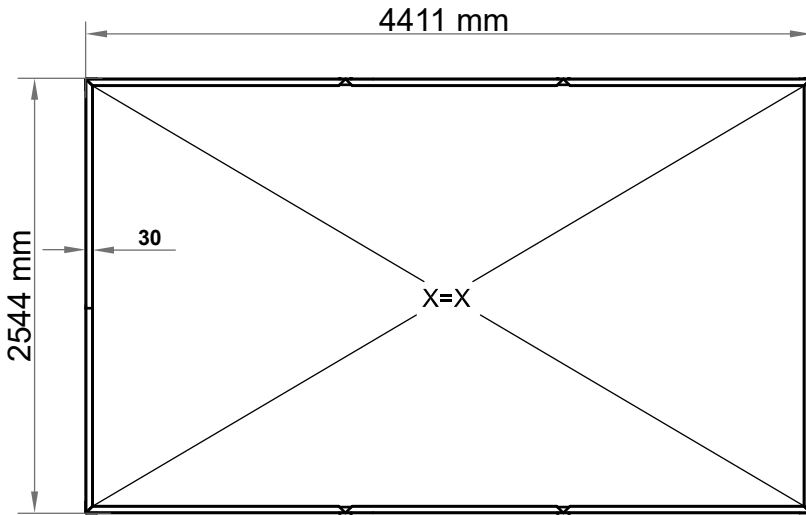

FACE AVANT (AVEC PORTE)
VORDERWAND (MIT TÜR)
FRONT WALL (WITH DOOR)



Plots béton / Punktfundament / Point foundation : D013 + D011 + D012.

Dalle ou pourtour béton / Streifenfundament / Concrete slab or frame : D013.

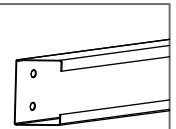
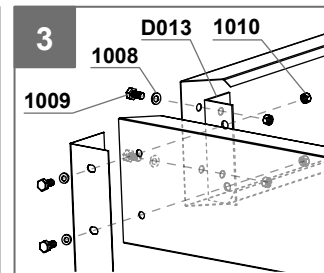
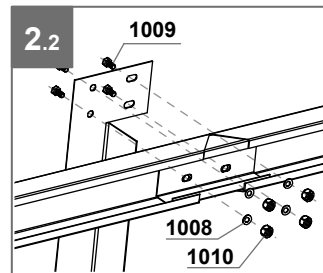
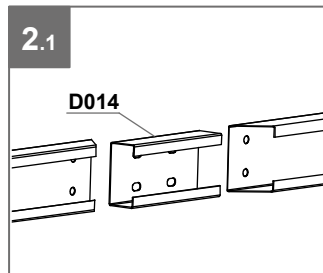
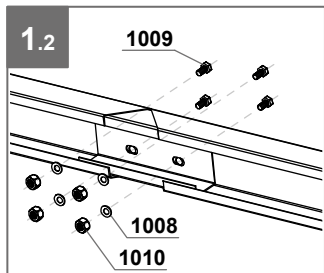

D007 x 4

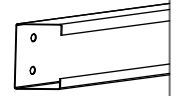

D008 x 2

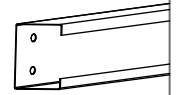

D009 x 2

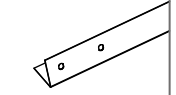

D011 x 4

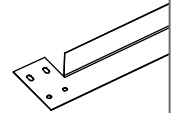

D012 x 2

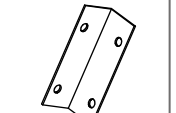

D013 x 4

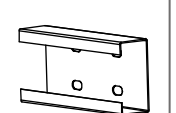

D014 x 4

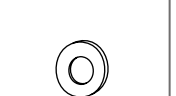

1008 x 32

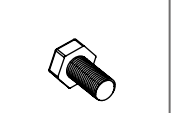

1009 x 32

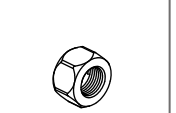

1010 x 32

Module d'extension
Erweiterungsmodul
Extension module

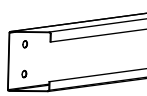

D010 x 2

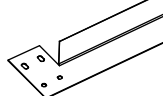

D012 x 2

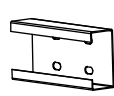

D014 x 2



1008 x 8



1009 x 8



1010 x 8



1010 x 32

FIXATION DE LA BASE AU SOL

FIXATION EN PLEINE TERRE

- Positionner la base à l'endroit voulu, de niveau sur un sol damé.
- Repérer l'emplacement des pattes de scellement suivant le schéma ci-dessous.
- Marquer un carré de 300 x 300 mm autour des pattes de scellement et creuser sur une profondeur de 450 mm.
- Placer la base, la mettre de niveau et remplir les trous de béton.

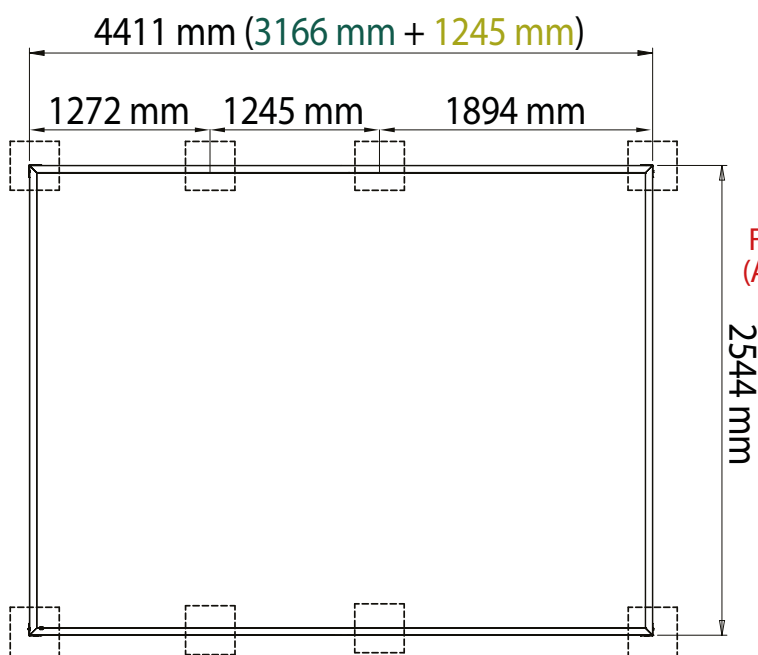

**FACE AVANT
(AVEC PORTE)**

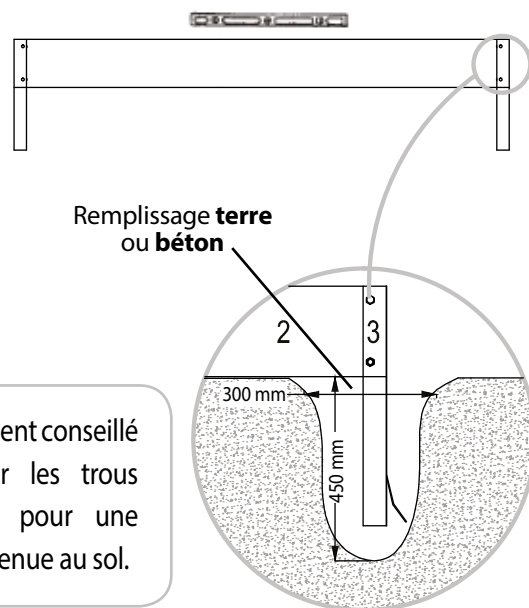

Il est vivement conseillé de remplir les trous de béton pour une meilleure tenue au sol.

Remplissage **terre** ou **béton**

OU

FIXATION SUR DALLE BÉTON

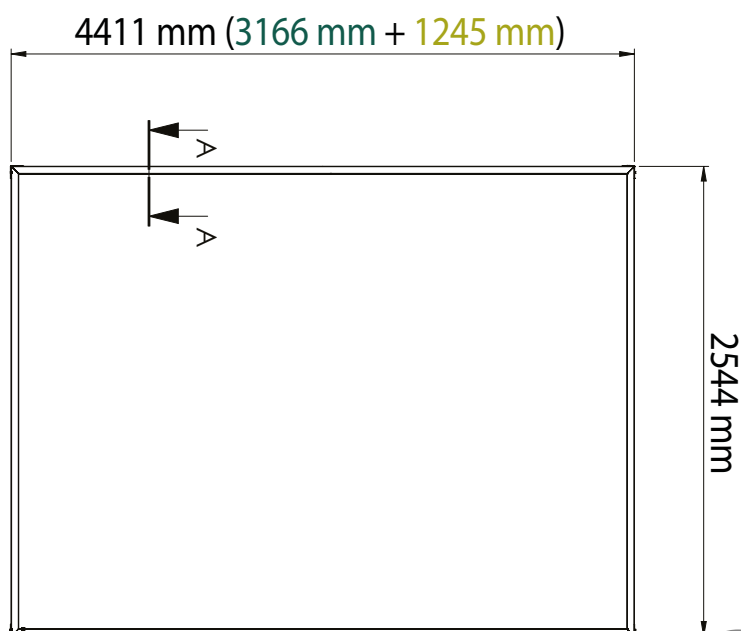

Détail A-A

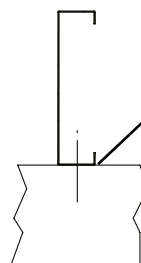

Fixation par chevilles à l'intérieur de la base



Visseries et chevilles de fixation non fournies

Il est laissé à votre libre choix et décision, l'utilisation des fixations adéquats selon les supports que vous décidez d'utiliser (pourtour bois, parpaings, plaques ciment, ...).



BEFESTIGUNG DES FUNDAMENTRAHMENS AM BODEN

BEFESTIGUNG AUF ERDBODEN (Punktfundament)

- Stellen Sie den Fundamentrahmen an der gewünschten Stelle, auf einem ebenen Boden.
- Finden Sie die Stelle der Ankerbeine gemäß dem untenstehenden Schema.
- Markieren Sie ein 300 x 300 mm Quadrat um die Ankerbeine herum und graben Sie 450 mm tief.
- Den Fundamentrahmen platzieren, nivellieren und die Löcher mit Beton füllen.

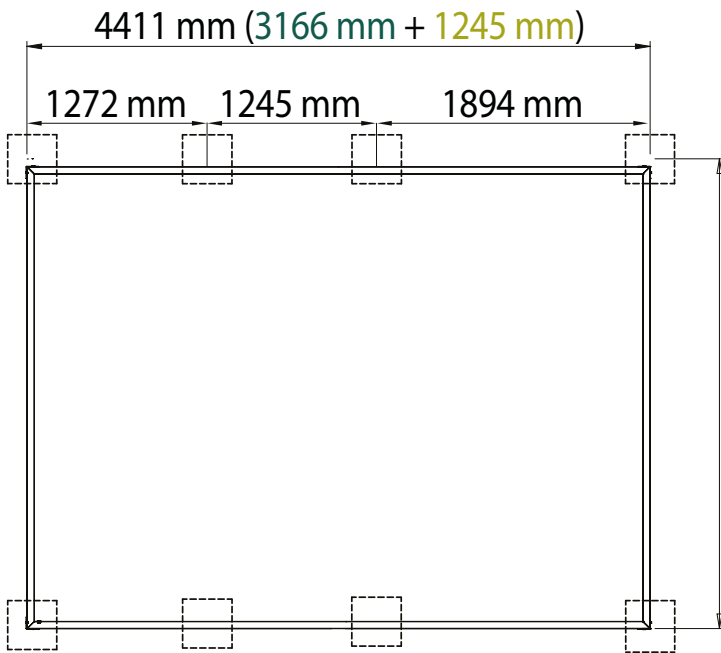

 **VORDERWAND (MIT TÜR)**

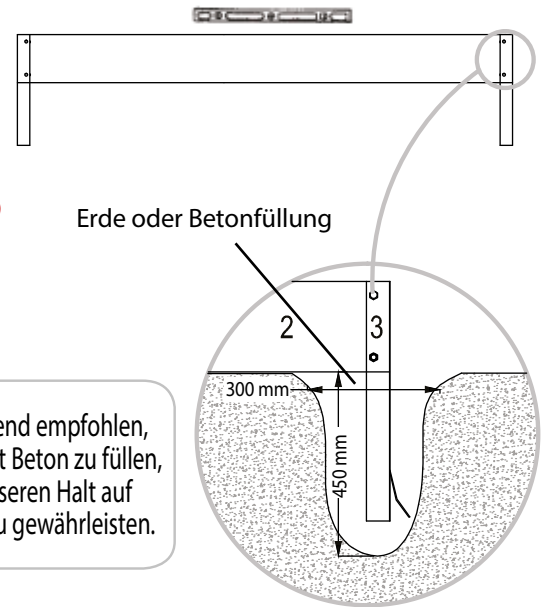

Es wird dringend empfohlen, die Löcher mit Beton zu füllen, um einen besseren Halt auf dem Boden zu gewährleisten.

ODER

BEFESTIGUNG AUF BETONDECKE (Streifenfundament)

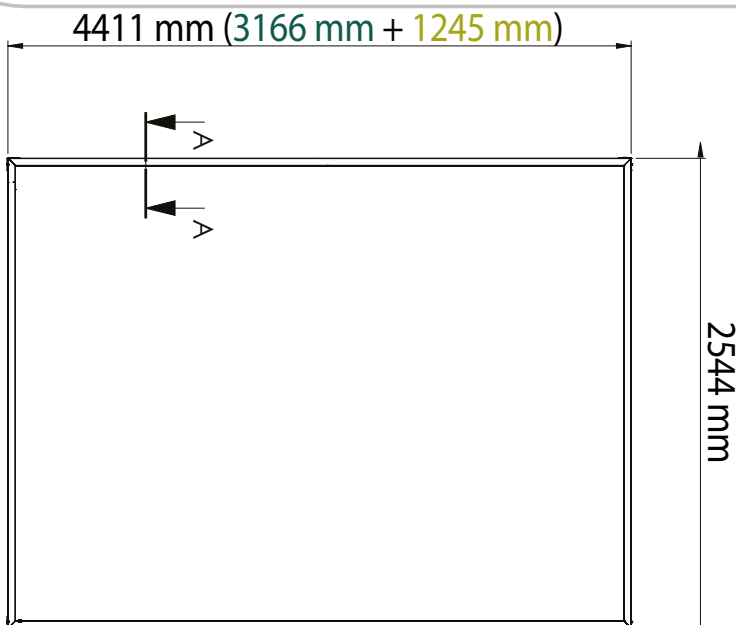

Detail A-A

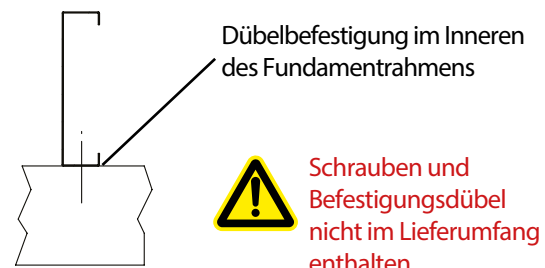

Es bleibt Ihrer freien Wahl und Entscheidung überlassen, die geeigneten Befestigungsmittel entsprechend der von Ihnen gewählten Träger (Holzumrandung, Bausteine, Zementplatten,...) zu verwenden.



FIXING THE GREENHOUSE BASE TO THE GROUND

FIXING ON SOIL (POINT FOUNDATION)

- Position the greenhouse base in the desired location at a level position.
- Locate the base legs as shown bellow.
- Mark a 300 x 300 mm square around the base legs and dig 450 mm deep.
- Place the greenhouse base, level it and fill the holes with concrete.

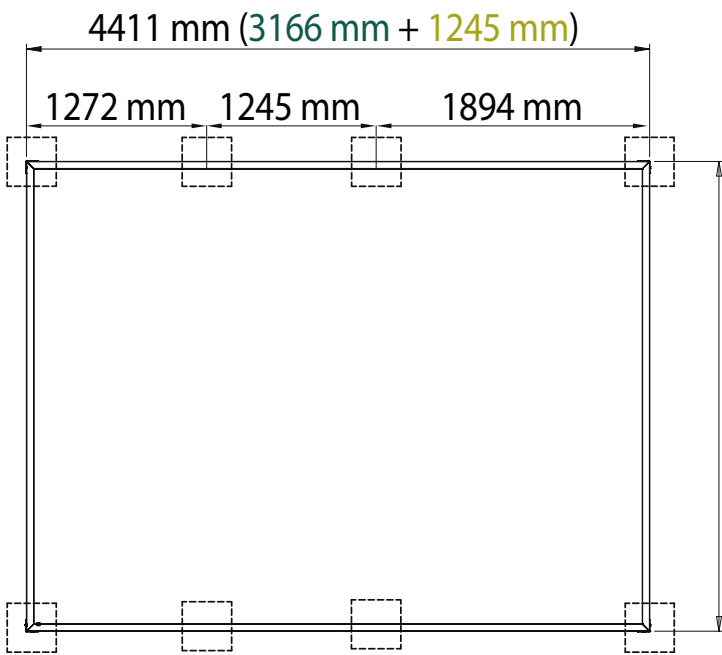

FRONT WALL
(WITH DOOR)

2544 mm

It is strongly recommended to fill the holes with concrete for a better hold on the ground.

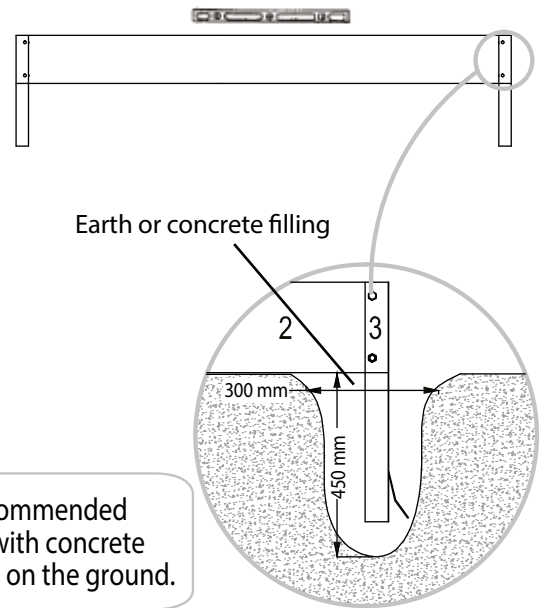

OR

FIXING ON CONCRETE SLAB

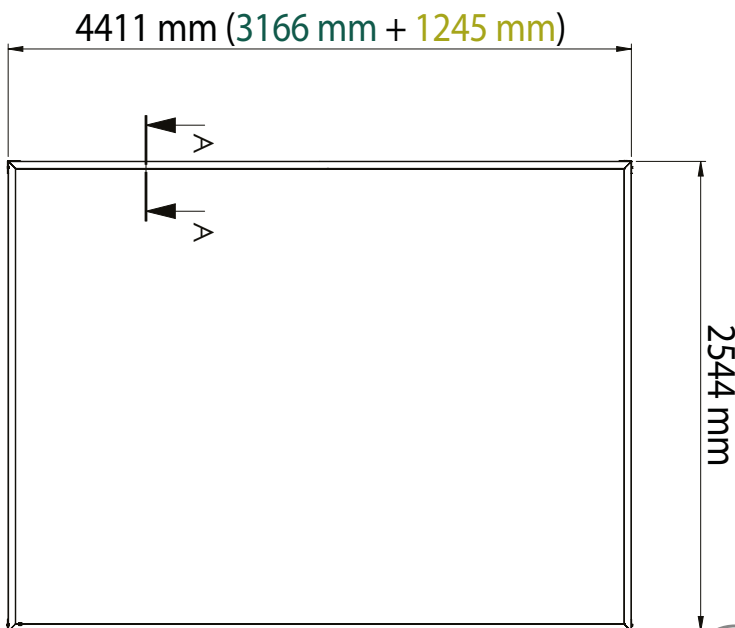

Detail A-A

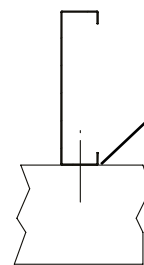

Rawplug fastening inside the greenhouse base



Screws and rawplugs not provided

It remains to your free choice and decision to use the suitable fastening means according to the supports you chose (wood border, building stones, cement plates etc.)

VIS 1002 & 1003 - SCHRAUBEN 1002 & 1003 - SCREWS 1002 & 1003

Mise en place des vis 1002 et 1003 dans les rainures en forme de T des profilés aluminium :
Entrez la tête de vis dans la rainure du profilé et tournez à 90° afin qu'elle ne puisse pas sortir du profilé. Assemblez la/les pièce(s) nécessaire(s) et serrez l'écrou.

Verwendung der Schrauben 1002 und 1003 in den t-förmigen Nuten der Aluminiumprofile :
Schraubenkopf in die Profilmutter stecken und diesen um 90° drehen, damit er nicht aus dem Profil herauskommt. Bauen Sie das/die benötigte(n) Einzelteil(e) zusammen und ziehen Sie die Schraubenmuttern an.

Principle of use of screws 1002 and 1003 in the T-shaped grooves of the aluminium profiles :
Enter the screw head into the groove of the profile and turn the screw head at 90° so that it cannot exit the profile. Assemble the required part(s) and tighten the screw nut.

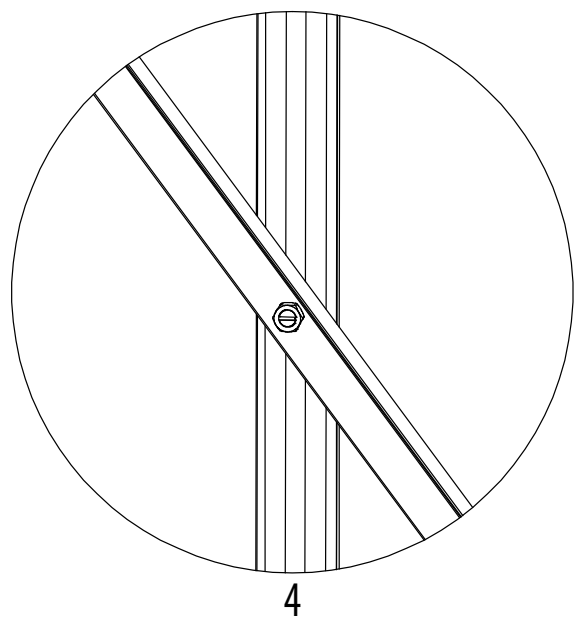
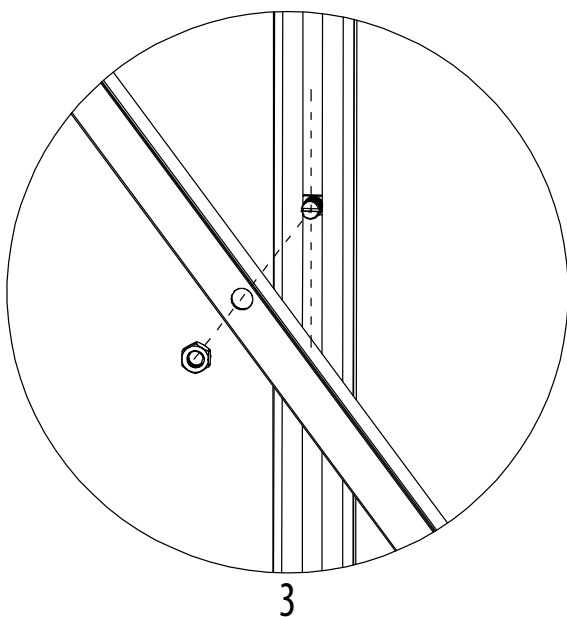
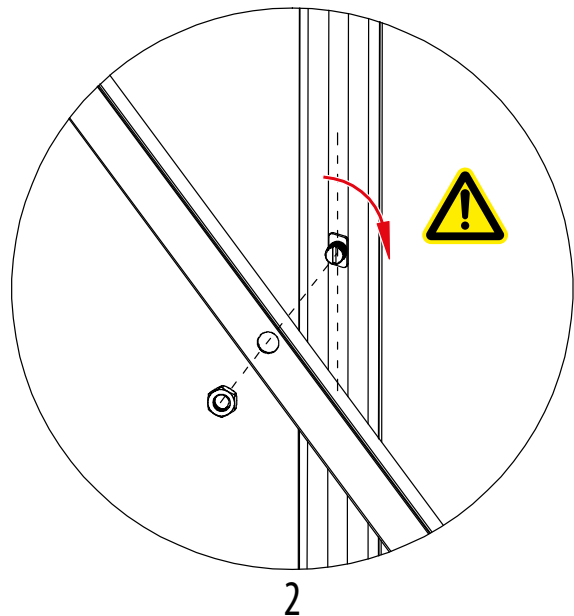
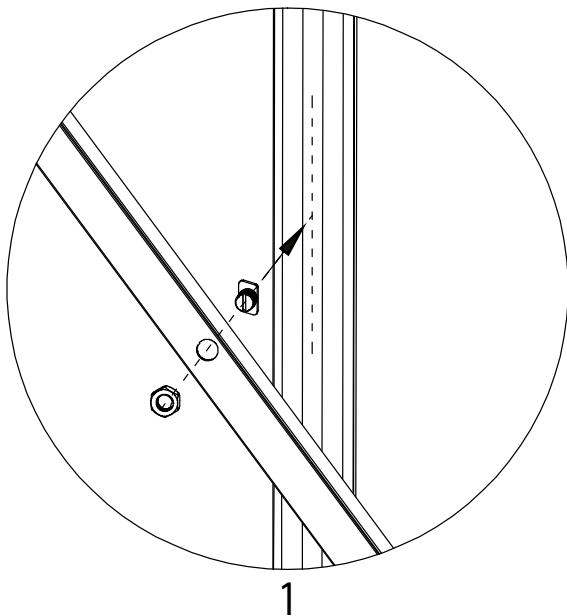

LONG-PAN (CÔTÉ) - SEITENWAND - SIDE WALL

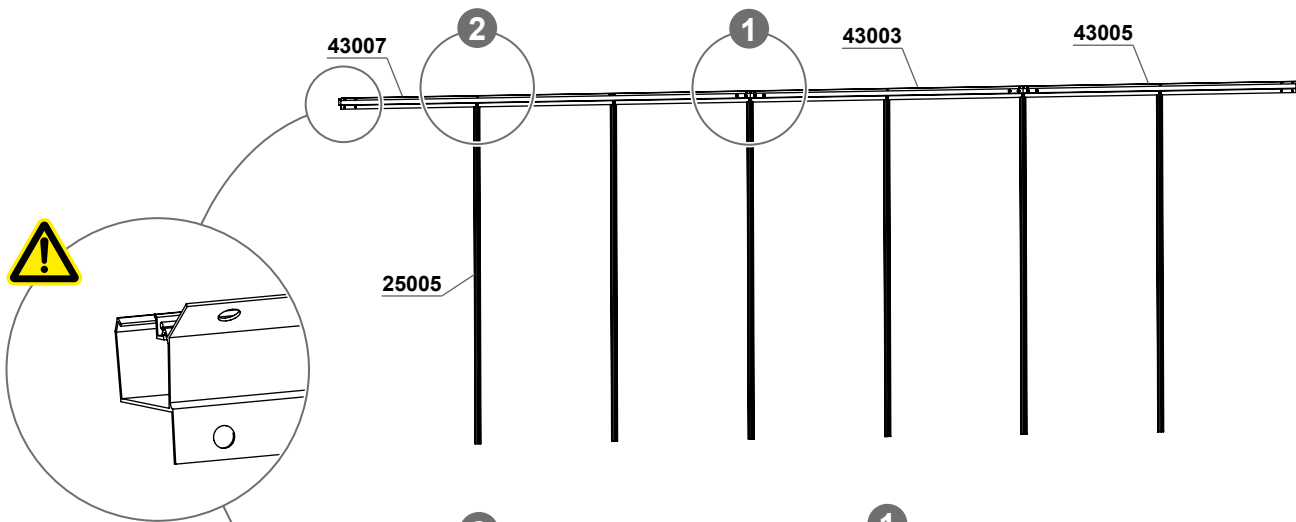

A1

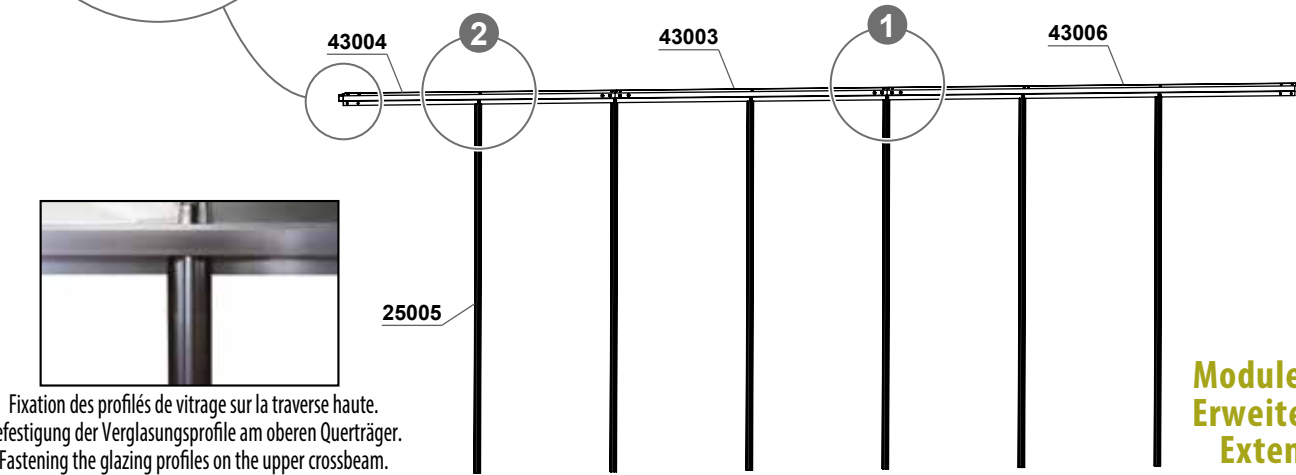

A2

Fixation des profilés de vitrage sur la traverse haute.
Befestigung der Verglasungsprofile am oberen Querträger.
Fastening the glazing profiles on the upper crossbeam.

Module d'extension
Erweiterungsmodul
Extension module

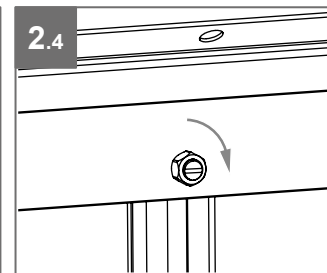
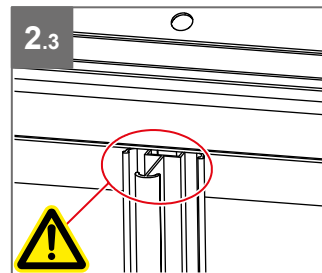
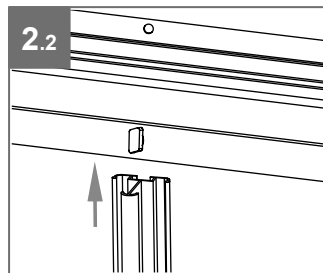
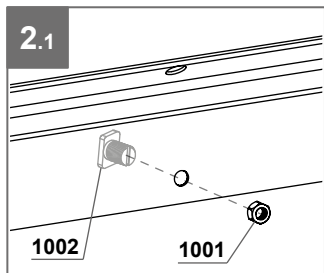
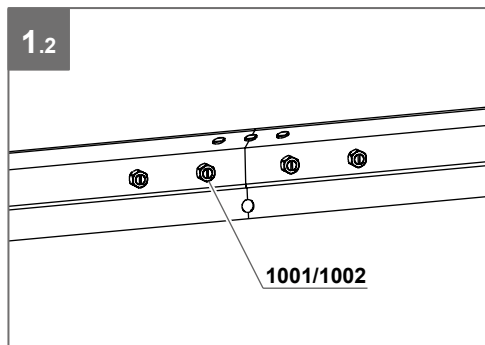
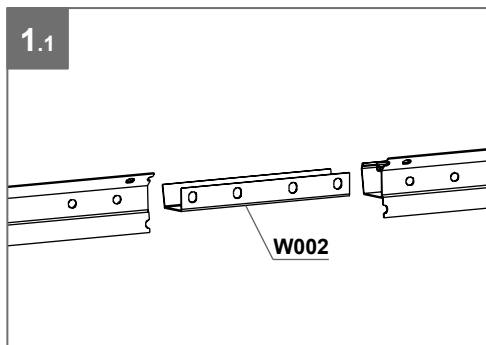

	25005 x 4
	43003 x 2
	W002 x 2
	1001 x 12
	1002 x 12

Module de base
Basismodul
Basic module

	25005 x 8		43004 x 1		43005 x 1		43006 x 1		43007 x 1		W002 x 2		1001 x 16		1002 x 16
--	-----------	--	-----------	--	-----------	--	-----------	--	-----------	--	----------	--	-----------	--	-----------

LONG-PAN (CÔTÉ) - SEITENWAND - SIDE WALL

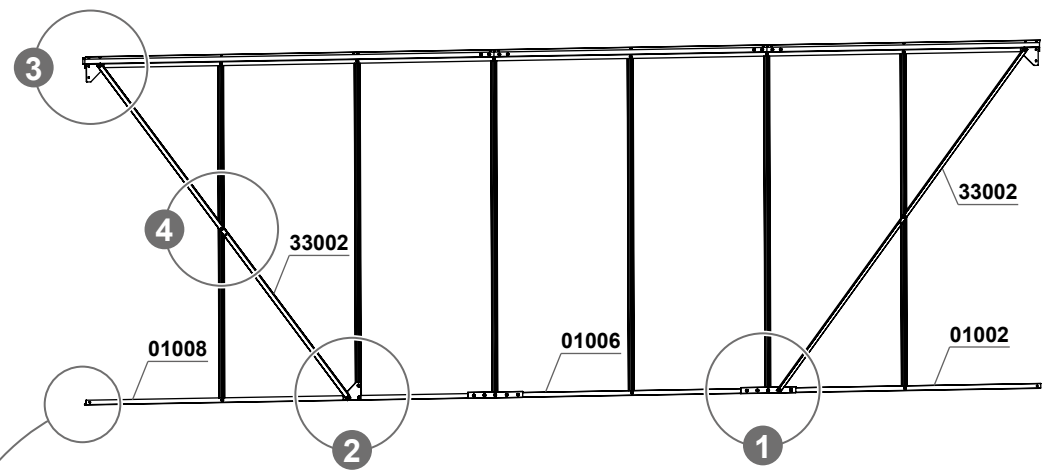

Module d'extension
Erweiterungsmodul
Extension module

A1



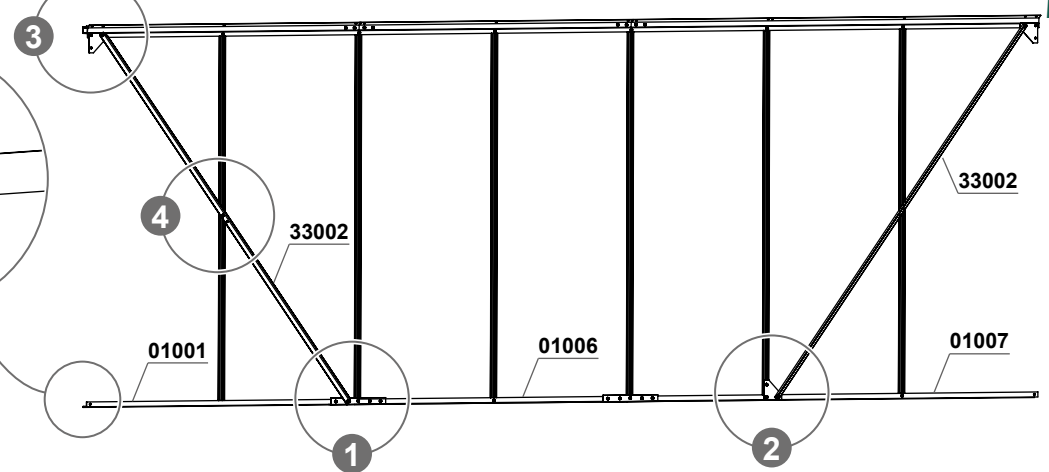

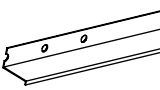
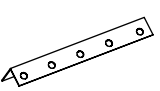

A2

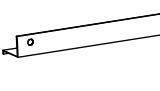
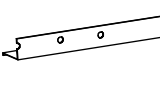
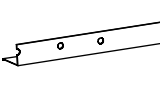
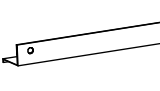
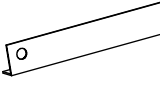
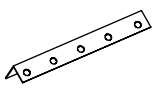

-  01006 x 2
-  46001 x 2
-  1001 x 12
-  1002 x 12

Module de base
Basismodul
Basic module

-  01001 x 1
-  01002 x 1
-  01007 x 1
-  01008 x 1
-  33002 x 4
-  46001 x 2
-  W003 x 6
-  1001 x 28
-  1002 x 28

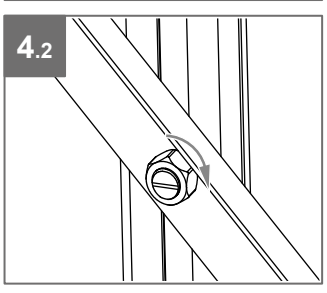
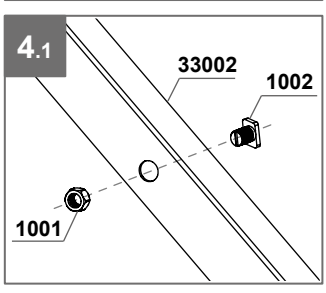
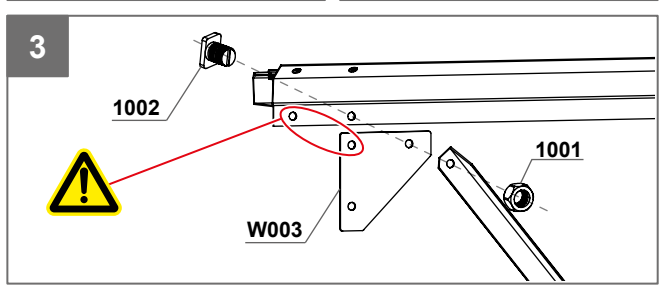
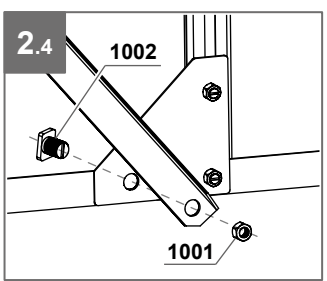
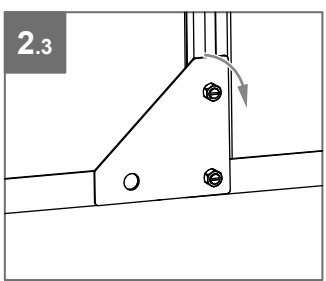
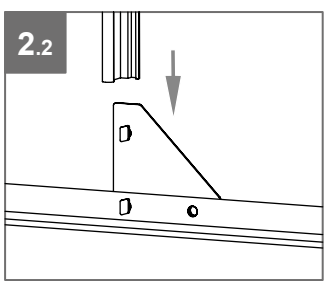
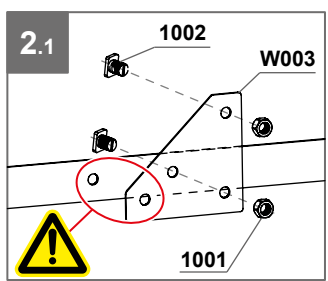
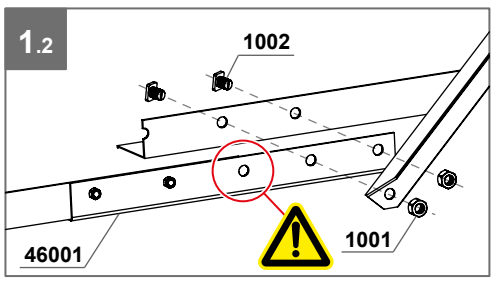
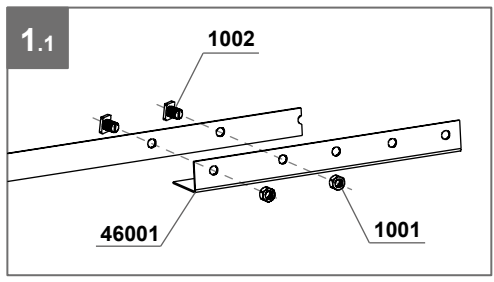

ÉTAPES SUIVANTES - NÄCHSTE SCHRITTE - NEXT STEPS

Montage de la face avant (avec porte) : pages 17-19
Montage der Vorderwand (mit Tür) : Seite 17-19
Assembling the front wall (with door) : pages 17-19

Montage de la face arrière (sans porte) : pages 20-22
Montage der Rückwand (ohne Tür) : Seite 20-22
Assembling the rear wall (without door) : pages 20-22

Montage de la porte : pages 23-24
Montage der Tür : Seite 23-24
Assembling the door : pages 23-24

Montage de la lucarne : page 25
Montage des Fensters : Seite 25
Assembling the window : page 25

Puis revenir à la page 45
Dann zurück auf Seite 45
Then back to page 45

ASSEMBLAGE DES PAROIS - ZUSAMMENBAU DER WÄNDE ASSEMBLY OF THE WALLS

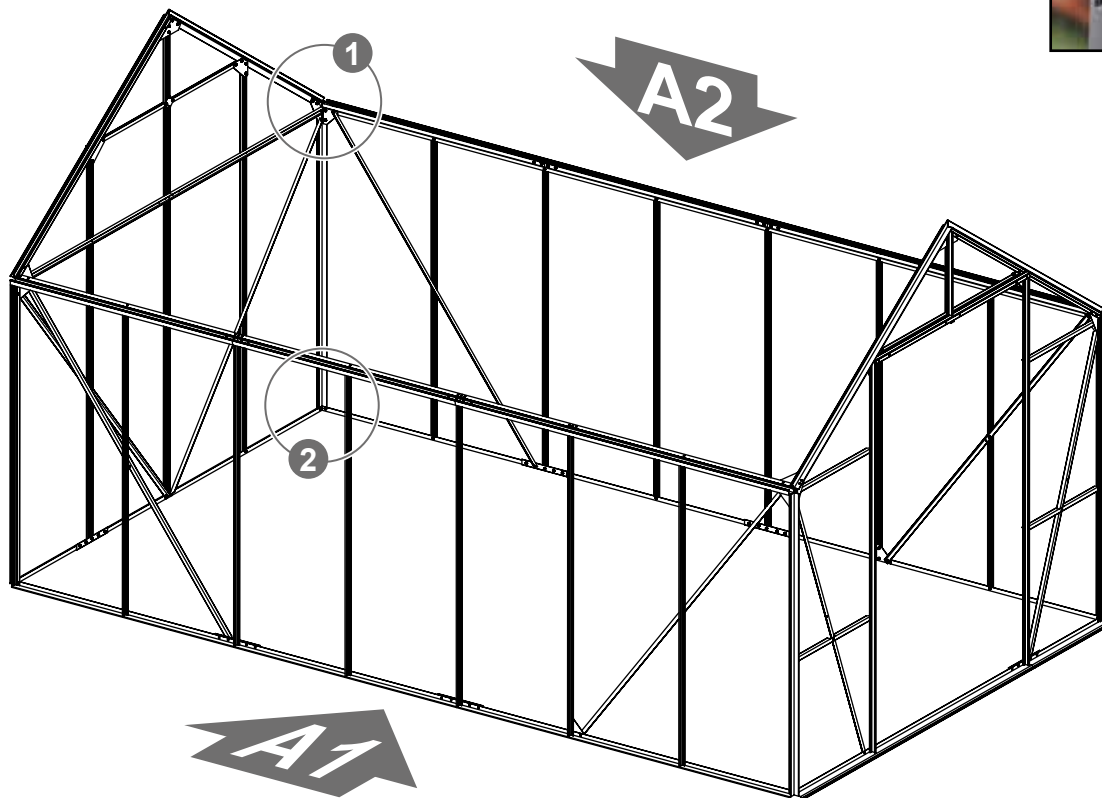

Module de base
Basismodul
Basic module

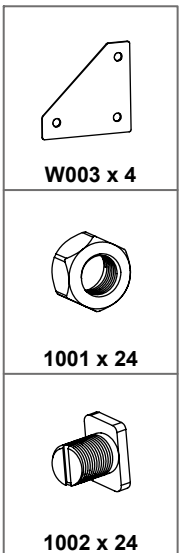
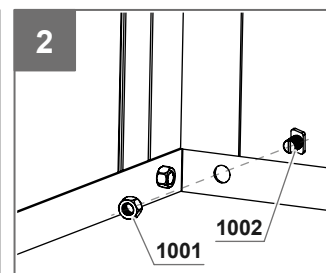
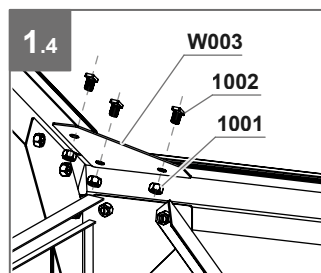
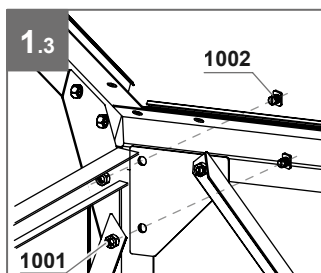
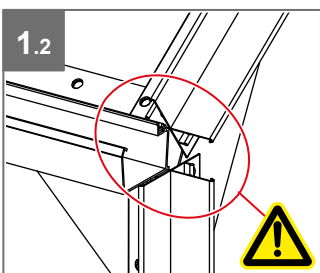
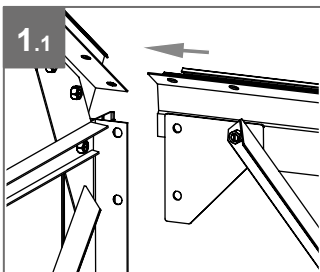

MONTAGE DES PROFILÉS DE TOITURE - MONTAGE DER DACHPROFILE ASSEMBLING THE ROOF PROFILES

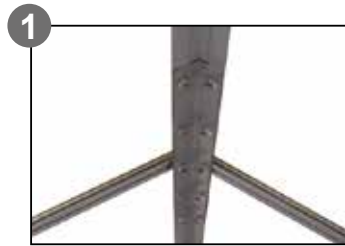
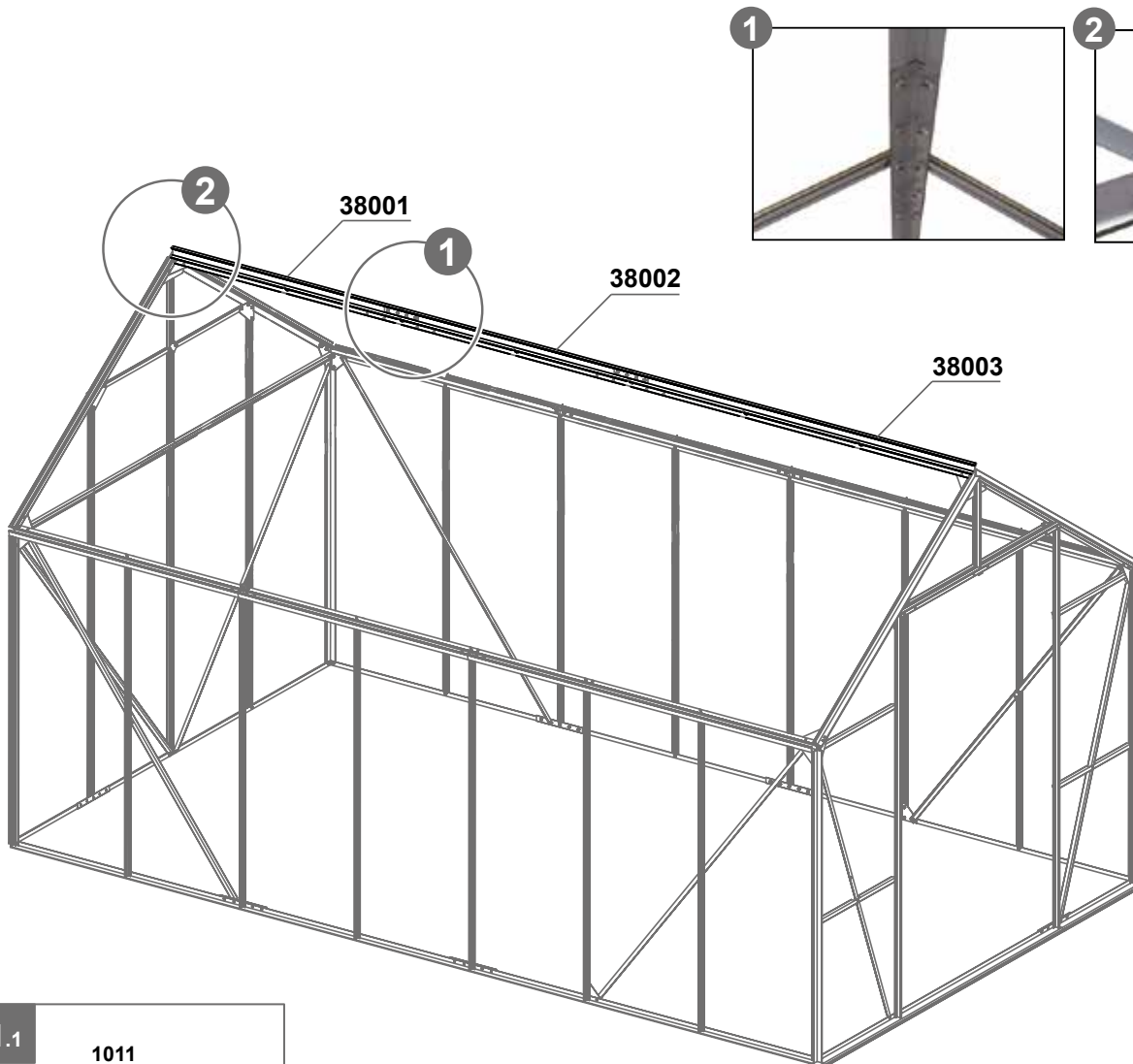

Module de base Basismodul Basic module

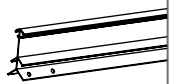

38001 x 1

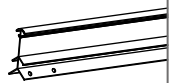

38003 x 1

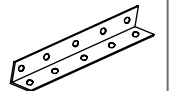

45001 x 1

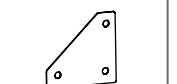

W003 x 4

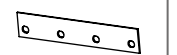

W004 x 2



1001 x 20

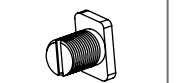

1002 x 12

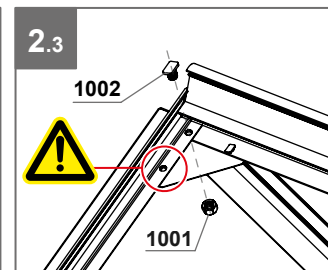
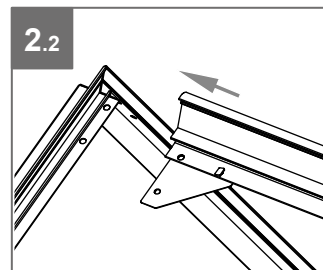
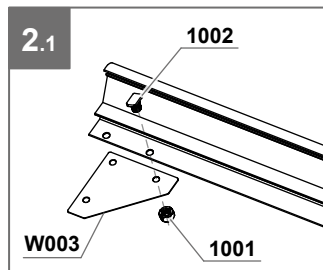
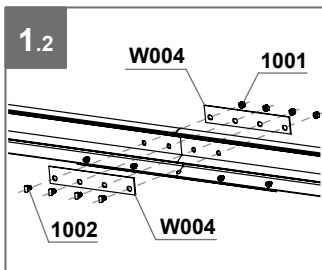
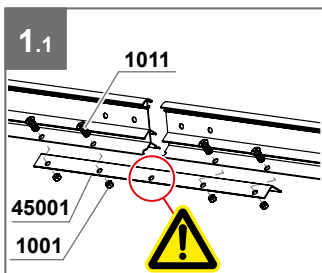

Module d'extension Erweiterungsmodul Extension module

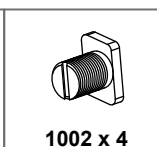
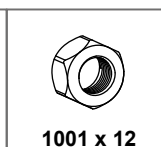
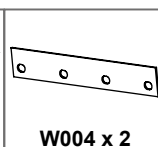
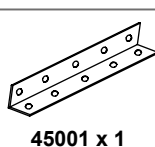
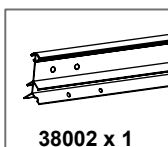

MONTAGE DES PROFILÉS DE TOITURE - MONTAGE DER DACHPROFILE ASSEMBLING THE ROOF PROFILES

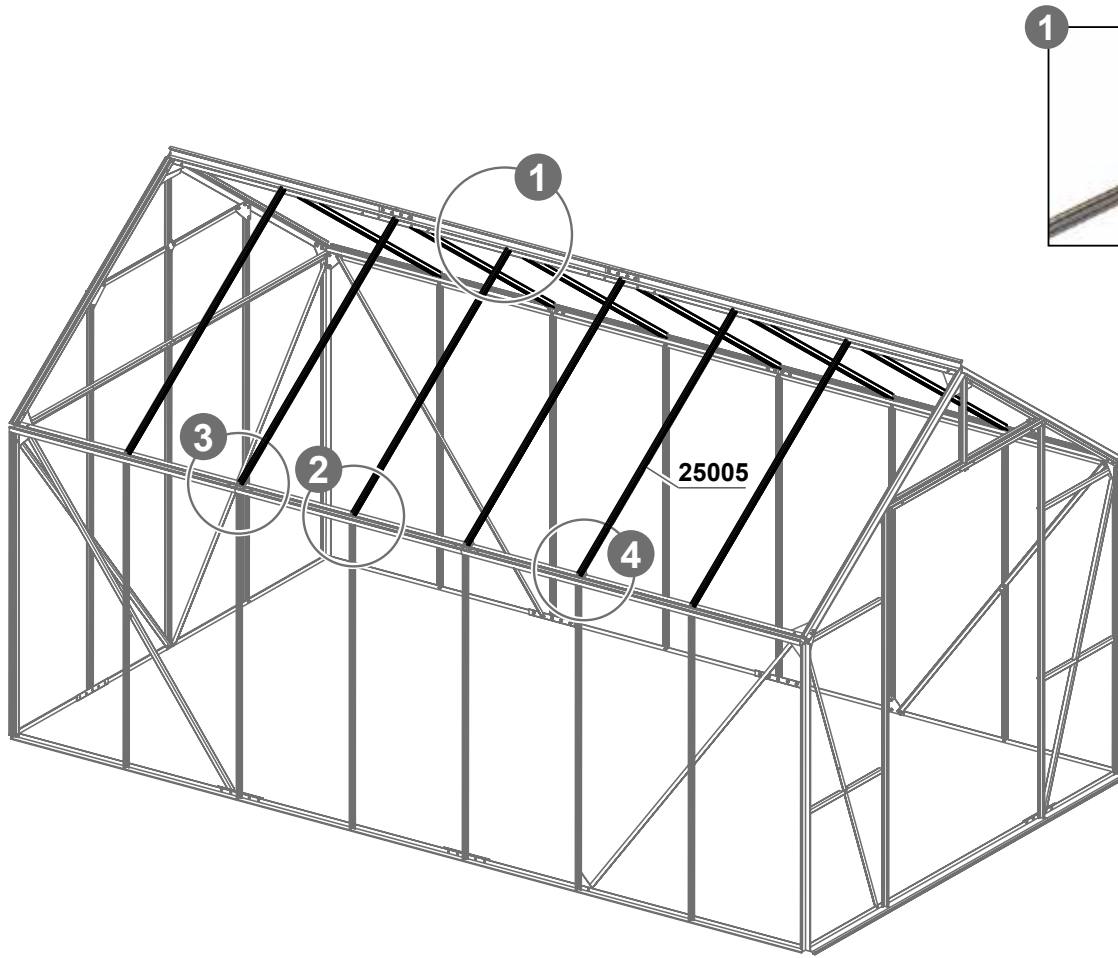

Module de base Basismodul Basic module

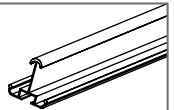

25005 x 8

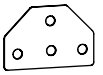

W005 x 2

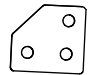

W020 x 2



1001 x 20



1002 x 20

Module d'extension Erweiterungsmodul Extension module

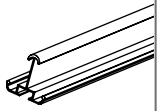

25005 x 4

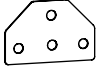

W005 x 2



1001 x 14



1002 x 14

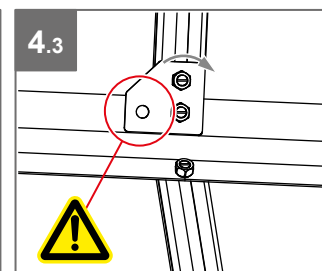
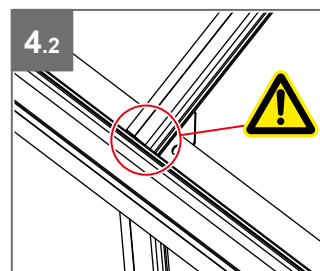
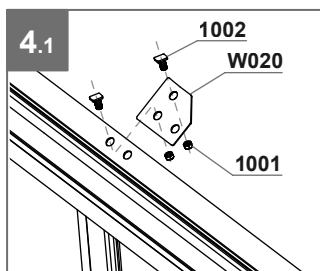
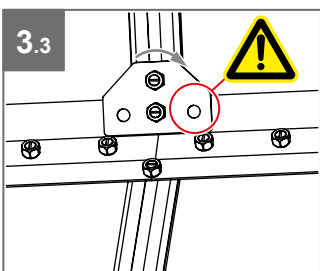
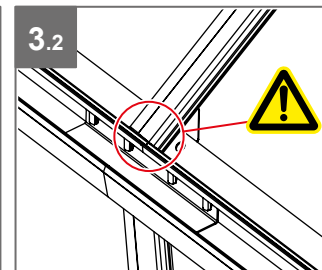
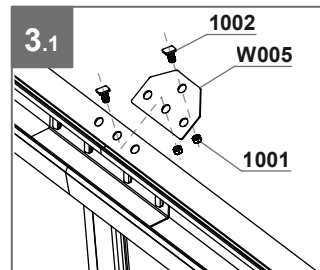
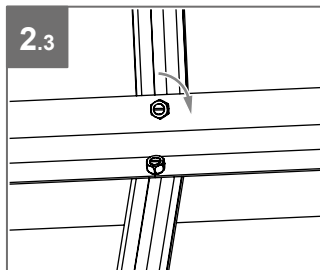
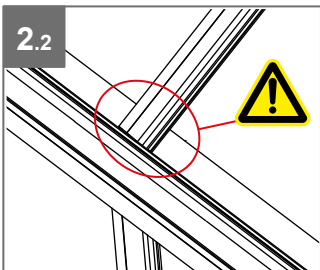
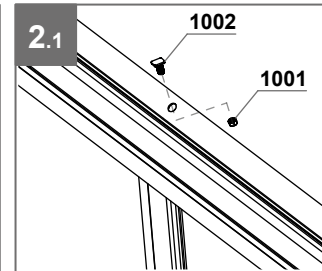
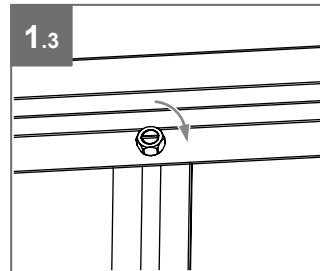
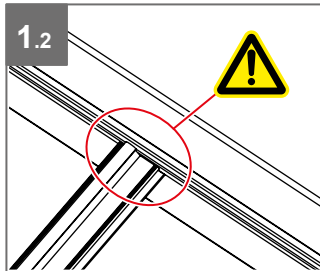
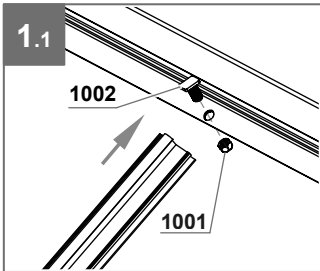

MONTAGE DES TENDEURS ET GOUSSETS SPANNVORRICHTUNG UND VERBINDER WIND BRACES AND GUSSETS

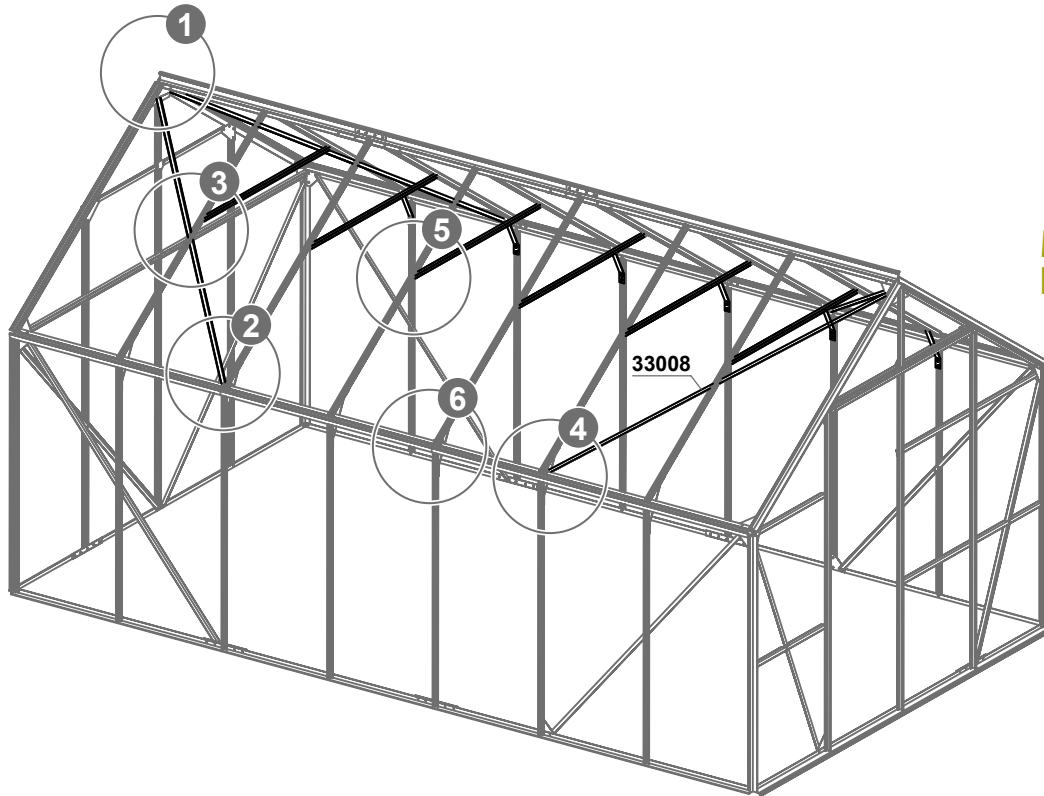

Module d'extension
Erweiterungsmodul
Extension module

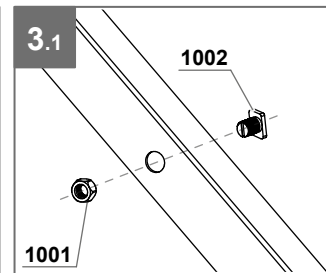
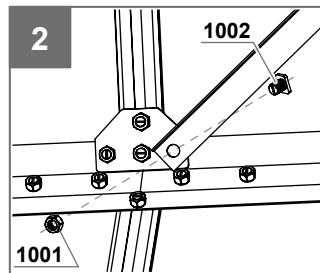
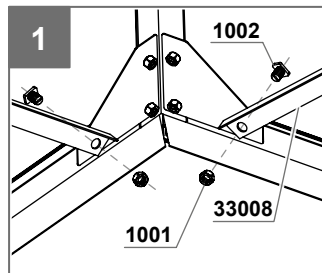
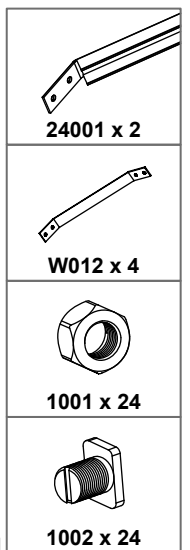

Module de base
Basismodul
Basic module

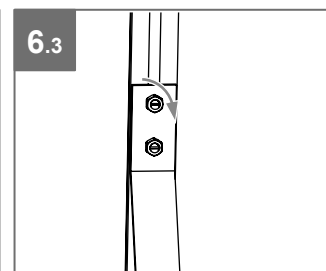
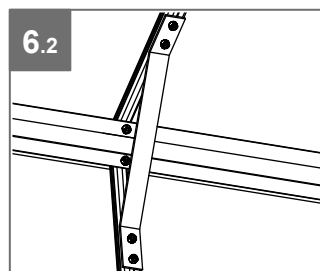
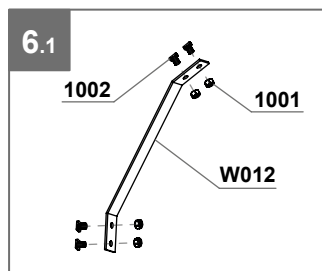
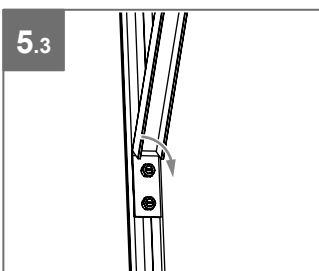
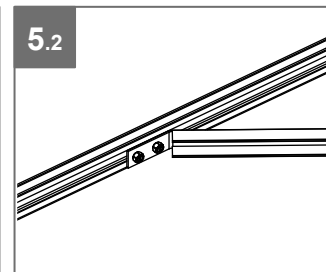
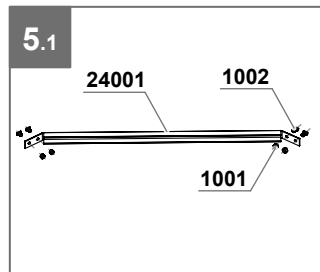
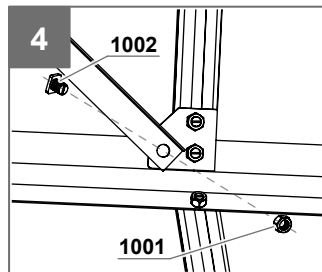
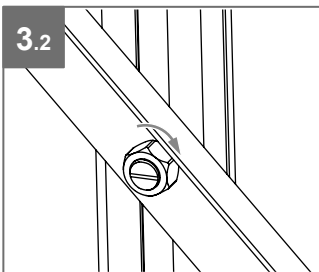
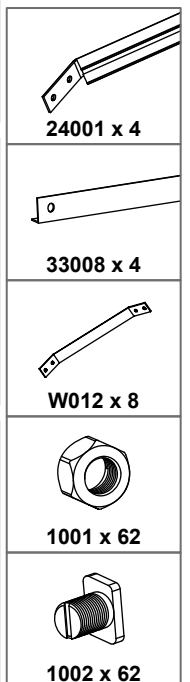

FIXATION DE LA SERRE SUR LA BASE BEFESTIGUNG DES GEWÄCHSHAUSES AM FUNDAMENTRAHMEN FASTENING THE GREENHOUSE BASE

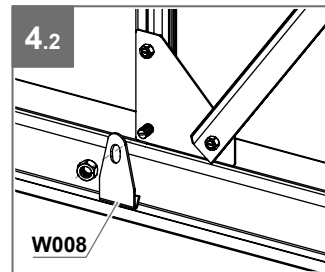
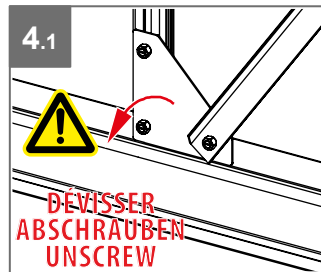
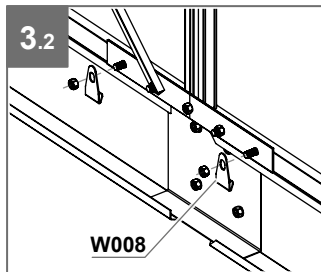
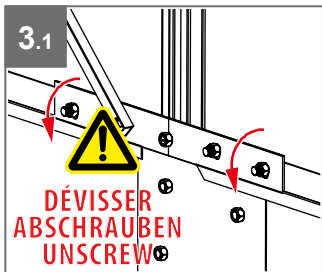
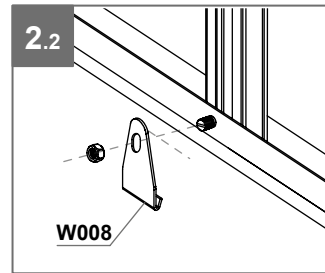
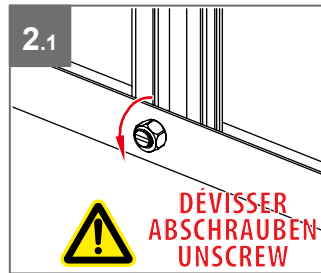
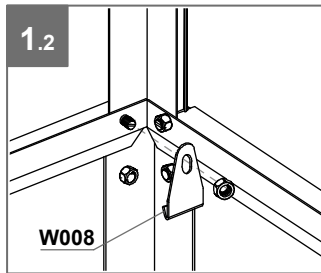
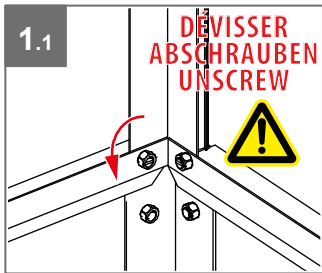
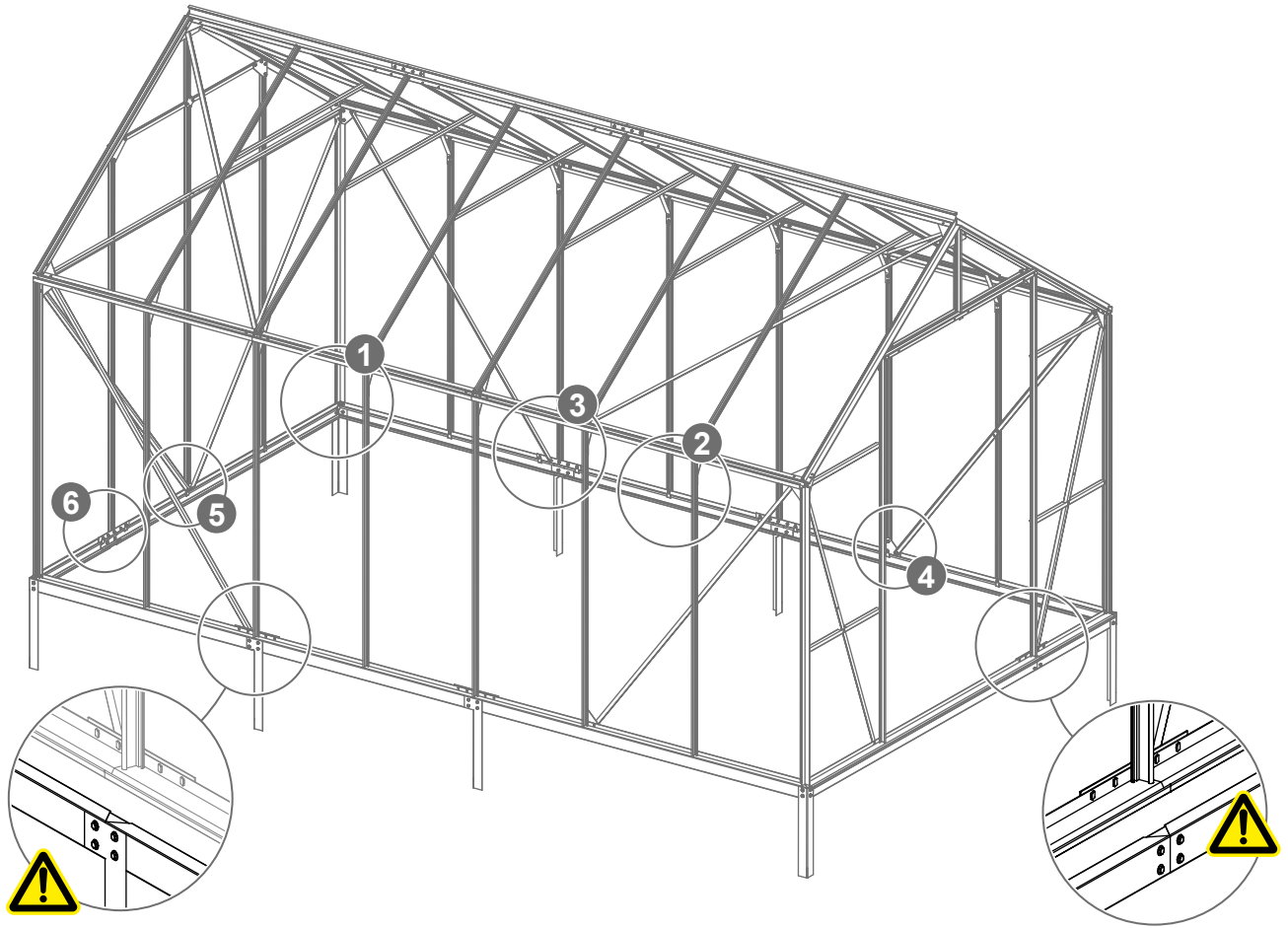

Module d'extension
Erweiterungsmodul
Extension module

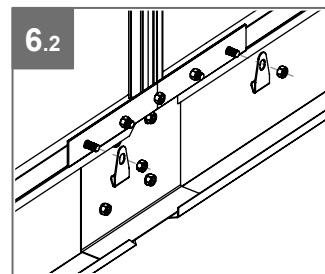
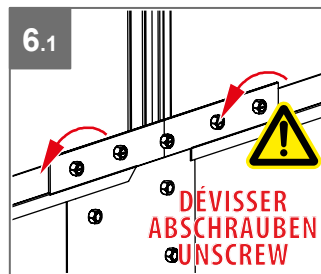
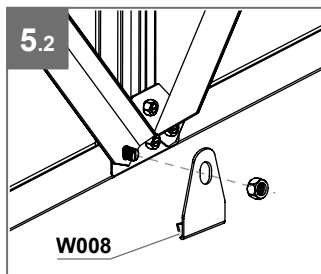
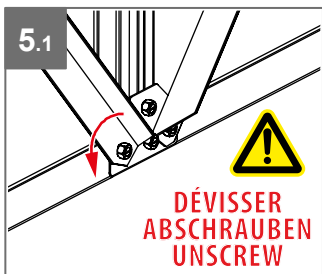
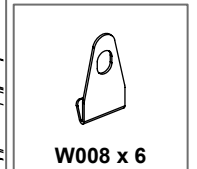

Module de base
Basismodul
Basic module



MONTAGE PORTE + RAIL MONTAGE TÜR + SCHIENE ASSEMBLING DOOR + RAIL



3



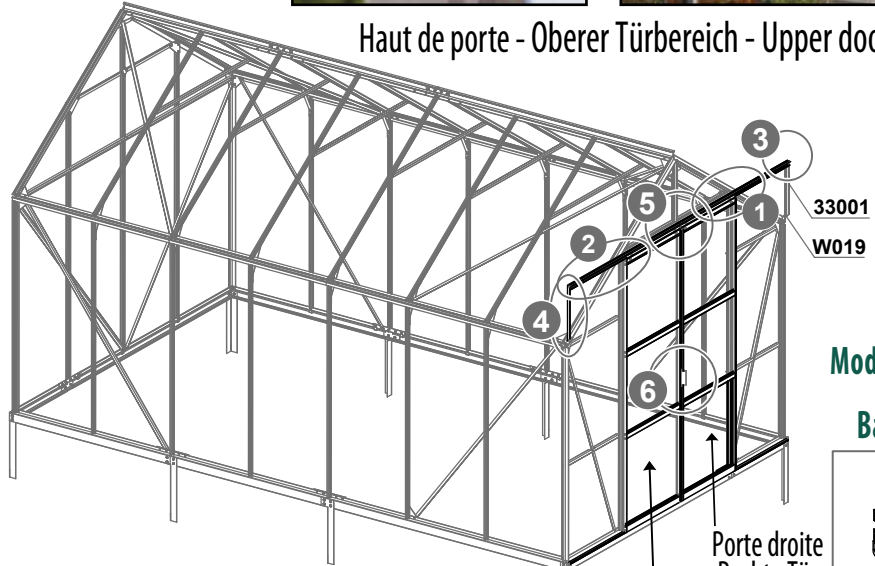
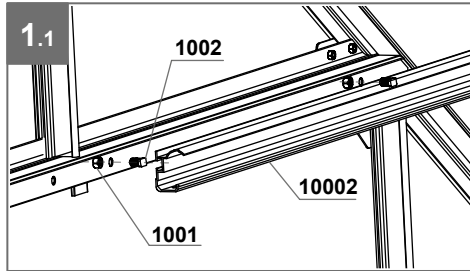

Recommandation : graissage régulier
Empfehlung : regelmäßig schmieren
Recommendation : grease regularly

Haut de porte - Oberer Türbereich - Upper door area

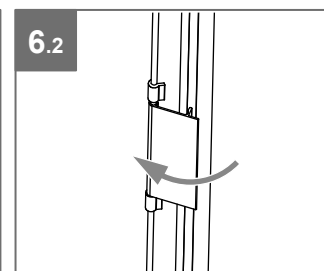
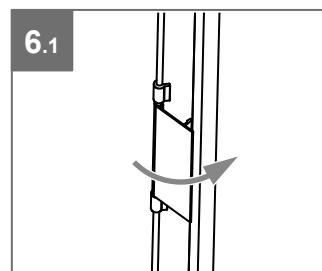
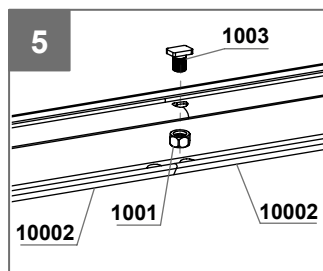
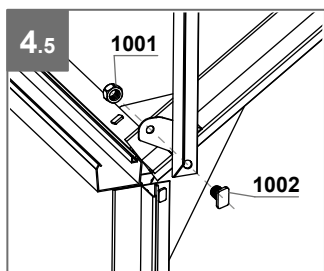
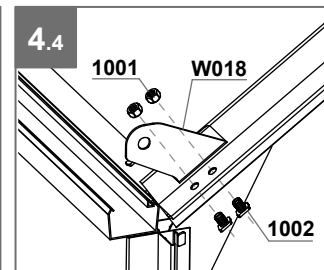
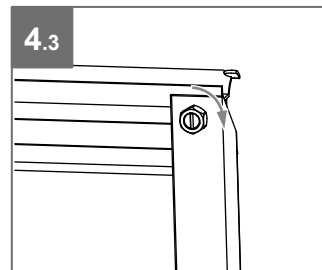
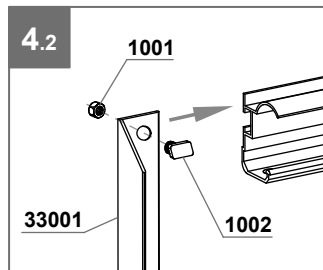
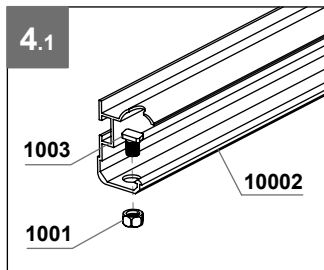
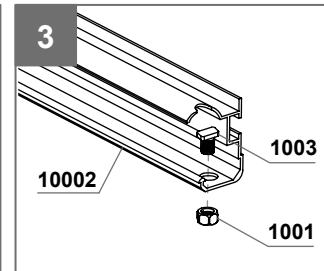
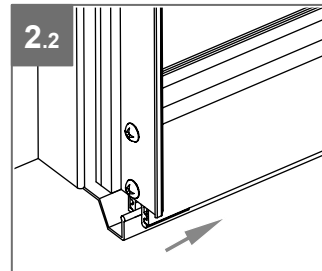
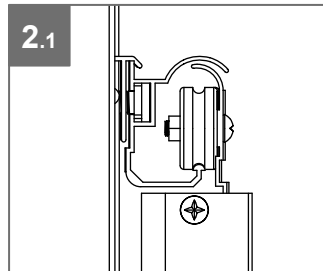
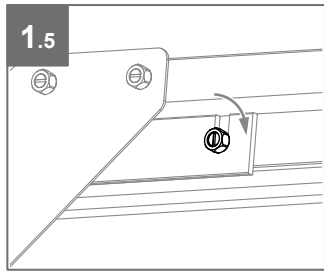
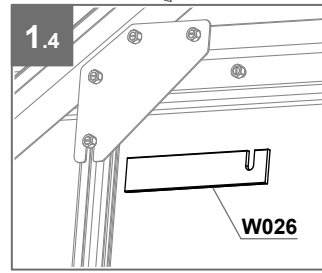
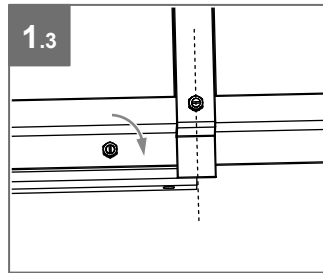
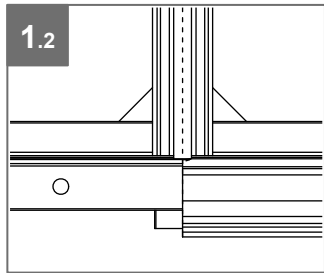

Module de base
Basismodul
Basic module

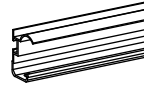

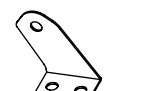
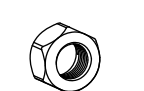
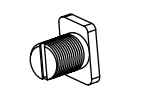
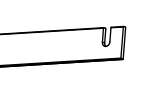
-  10002 x 2
-  33001 x 2
-  W018 x 1
-  W019 x 1
-  1001 x 15
-  1002 x 12
1003 x 3
-  W026 x 2

VITRAGE - VERGLASUNG - GLAZING

Nous vous conseillons d'installer les verres niveau par niveau (du bas vers le haut).



Wir empfehlen Ihnen, die Gläser Ebene für Ebene anzubringen (von unten nach oben).

We advise you to install the glazing level by level (from bottom to top).



Crochets de vitrage
Verglasungshaken
Glazing hooks



Clips de vitrage
Gewächshausklammern
Glazing clips

Module de base Basismodul Basic module

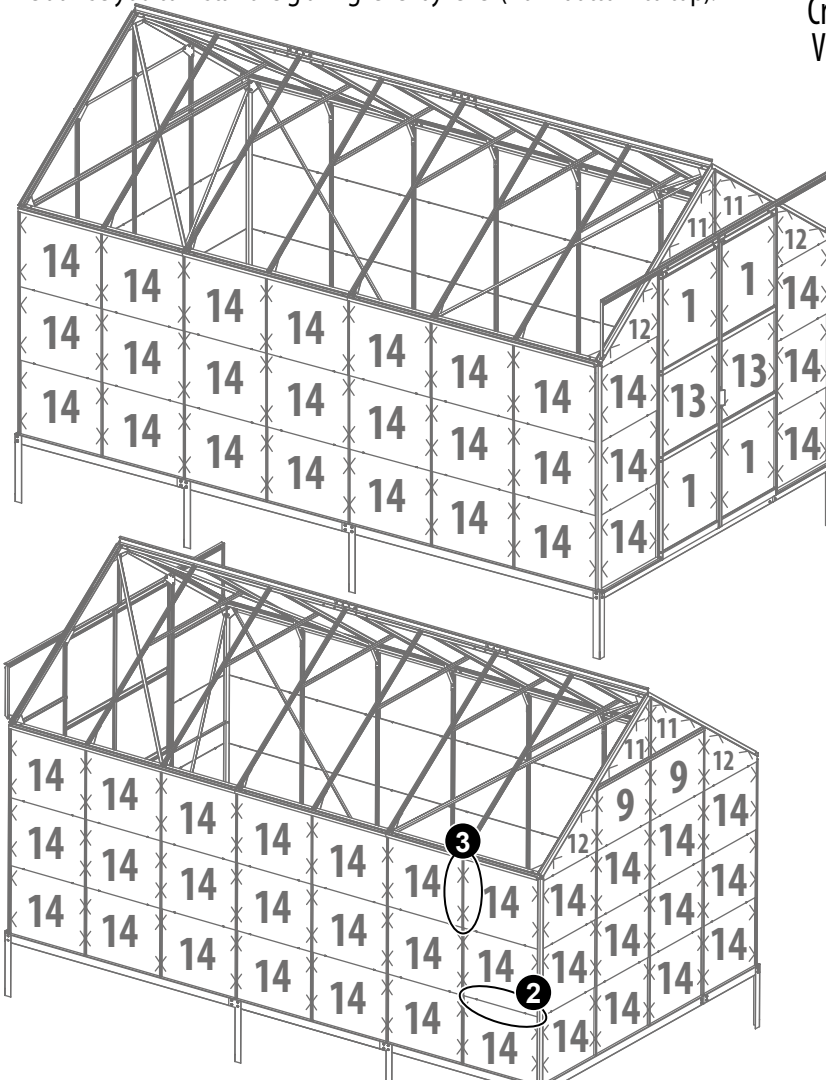

Il peut être nécessaire de dévisser temporairement certains profilés pour la mise en place des verres.

Resserer correctement les vis après la pose des verres.

Zum Anbringen der Gläser kann es erforderlich sein, bestimmte Profile vorübergehend abzuschrauben. Schrauben Sie diese nach der Anbringung der Gläser wieder fest.

Some profiles may need to be temporarily unscrewed to install the glazing. Refix the screws correctly after installing the glazing.

1

2006

Pose du joint. Voir page 31.
Puis continuez.

Dichtung anbringen (s. S. 31).
Dann fortfahren.

Attach seal (s. p. 31).
Then continue.

2

W006

3

W007

610 x 610	
1 x 4	
610 x 461	
9 x 2	
610 x 434/8	
11 x 4	
610 x 468/44	
12 x 4	
610 x 540	
13 x 2	
610 x 509	
14 x 48	

Module d'extension Erweiterungsmodul Extension module

610 x 509			
14 x 12	2006 x 24m	W006 x 16	W007 x 48

2006 x 105m	W006 x 76	W007 x 256

VITRAGE + POSE LUCARNE VERGLASUNG + FENSTER EINBAUEN GLAZING + INSTALLING WINDOW



Lucarne - vue extérieure
Fenster - Außenansicht
Window - exterior view



Pose de la lucarne sur faîtière
par glissement.
Anbringung des Fensters auf
First durch Gleiten.
Installing the window on
roof ridge through sliding.

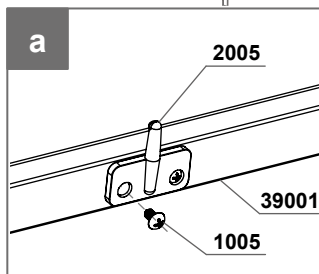
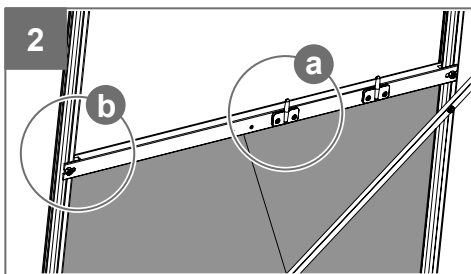
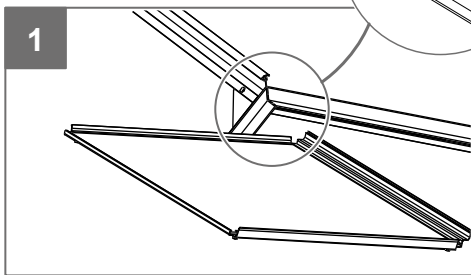
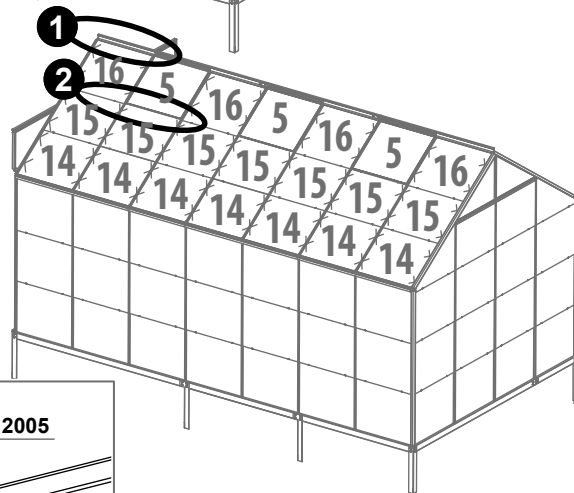
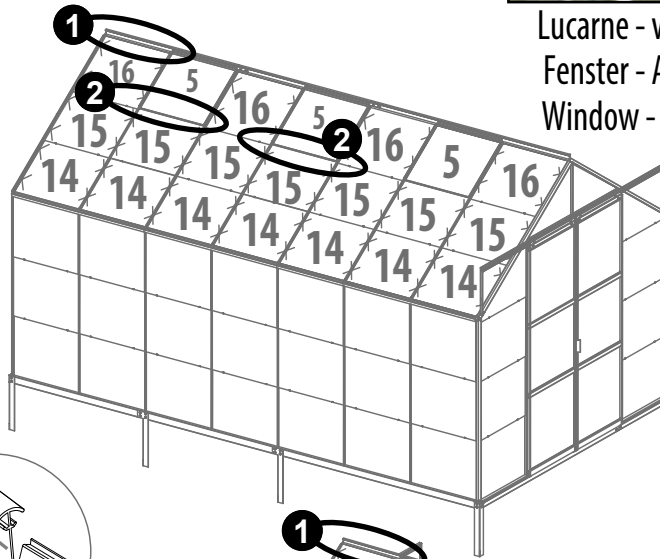

Couper le joint pour
passage de la pièce 39001

Dichtung schneiden um Einzelteil 39001 durchzulassen
Cut the seal to let part 39001 through

Module d'extension Erweiterungsmodul Extension module

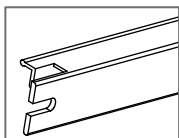

39001 x 2



1001 x 4



1002 x 4



1005 x 8



2005 x 4



W006 x 12



W006 x 40

Module de base Basismodul Basic module

610 x 509



14 x 10

610 x 487



15 x 10

610 x 549



16 x 6

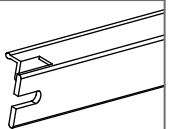

39001 x 4



1001 x 8



1002 x 8



1005 x 16



2005 x 8



W006 x 32



W006 x 104

MONTAGE DES PIÈCES PLASTIQUES

MONTAGE DER KUNSTSTOFFTEILE





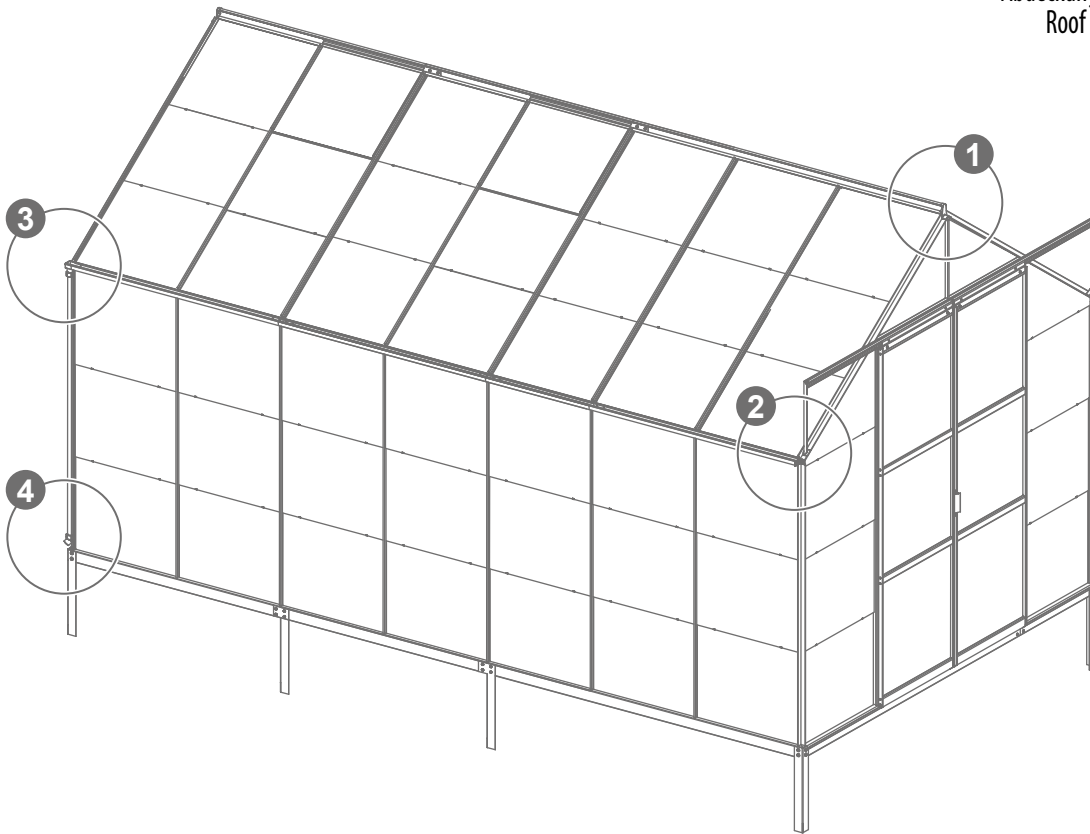

INSTALLING THE PLASTIC PARTS



Détail embout de faîtière (pièce 2010)
Abdeckung der Firstspitze (Einzelteil 2010)
Roof ridge end cover (part 2010)

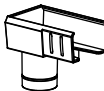

Module de base Basismodul Basic module

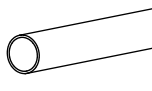
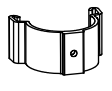
	1005 x 4
	2010 x 2
	2022 x 2
	2023 x 2
	2028 x 2
	2032 x 2
	2034 x 2
	58001 x 4

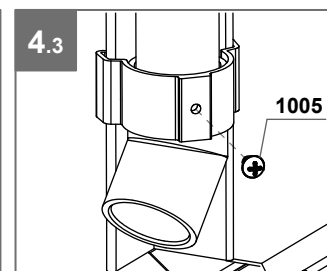
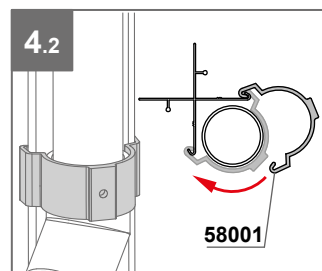
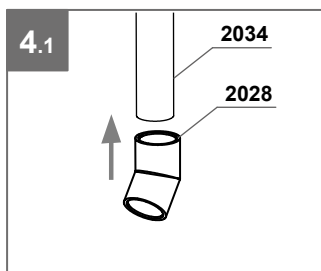
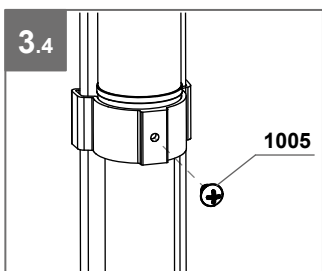
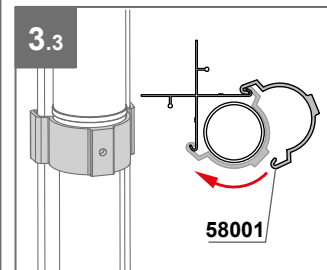
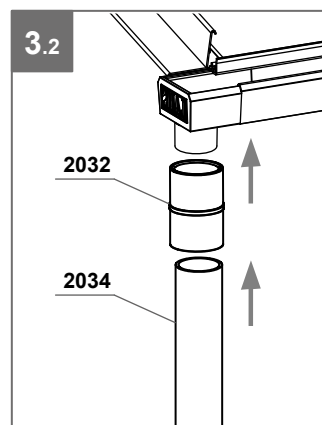
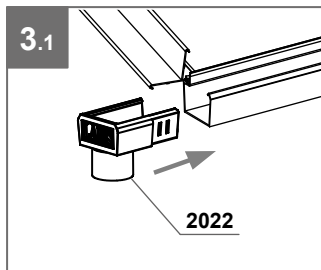
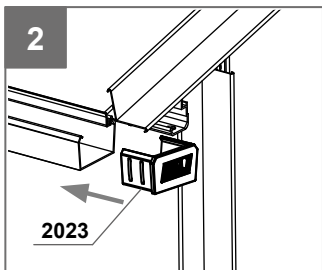
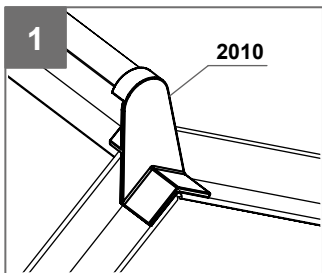

SERRE - GEWÄCHSHAUS - GREENHOUSE

LAURUS 12,90 M²

Module de base 8,10 m² + module d'extension 4,80 m²











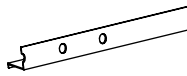
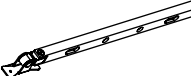
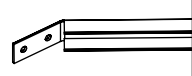

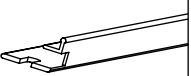



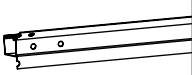
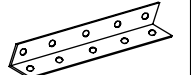
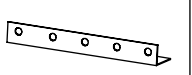



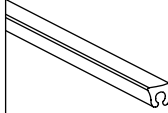
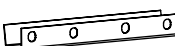
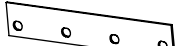
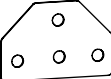

Basismodul 8,10 m² + Erweiterungsmodul 4,80 m²

Basic modul 8,10 m² + extension module 4,80 m²

NOMENCLATURE EXTENSION - STÜCKLISTE ERWEITERUNG BILL OF MATERIALS EXTENSION

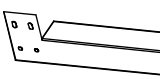
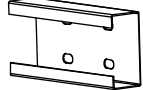
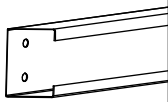





Colis - Paket - Parcel

1/2

PROFILÉS ALUMINIUM - ALUMINIUMPROFILE - ALUMINIUM PROFILES						
01011 x 2  L:1866 mm	15001 x 2  L:270 mm	24001 x 3  L:1160 mm	25005 x 12  L:1511 mm	38004 x 1  L:1866 mm	39001 x 2  L:634 mm	40001 x 2  L:602 mm
41001 x 4  L:518 mm	42001 x 2  L:602 mm	43008 x 2  L:1866 mm	45001 x 1  L:400 mm	46001 x 2  L:250 mm		
PETITS COMPOSANTS - KLEINTEILE - SMALL COMPONENTS						
1001 x 106  M6	1002 x 94 (M6 x 12 mm)  1003 x 4 (M6 x 8 mm)	1005 x 12  M3.5 x 6 mm	1015 x 4  Ø6	1011 x 8  M6 x14 mm	2004 x 2 	2005 x 4 
2006 x 37m 	W002 x 2 	W004 x 2 	W005 x 2 	W006 x 44 	W007 x 136 	W012 x 6 
BASE ET VISSERIE - FUNDAMENTRAHMEN UND SCHRAUBEN - GREENHOUSE BASE AND SCREWS						
D012 x 2 	D014 x 2 	D015 x 2  1866x60x30 mm	W008 x 8 	1008 x 8  Ø6	1009 x 8  M6 x12 mm	1010 x 8  M6

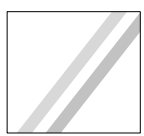
Colis - Paket - Parcel

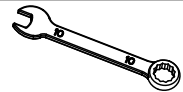
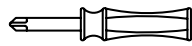
2/2

VERRES - GLÄSER - GLAZING						
5 x 2  600 x 544 mm	14 x 24  610 x 509 mm	15 x 6  610 x 487 mm	16 x 4  610 x 549 mm			
OUTILS INCLUS VORHANDENES WERKZEUG TOOLS INCLUDED		NON INCLUS NICHT VORHANDEN NOT INCLUDED				
 M6/10 mm	 M6/10 mm		 10 m			

MONTAGE BASE - MONTAGE FUNDAMENTRAHMEN - BASE ASSEMBLING

Il est impératif que la base soit montée de niveau.



Es ist zwingend erforderlich, dass der Fundamentrahmen auf einem ebenen Untergrund montiert wird.

It is imperative that the greenhouse base is leveled.

Module de base
Basismodul
Basic module

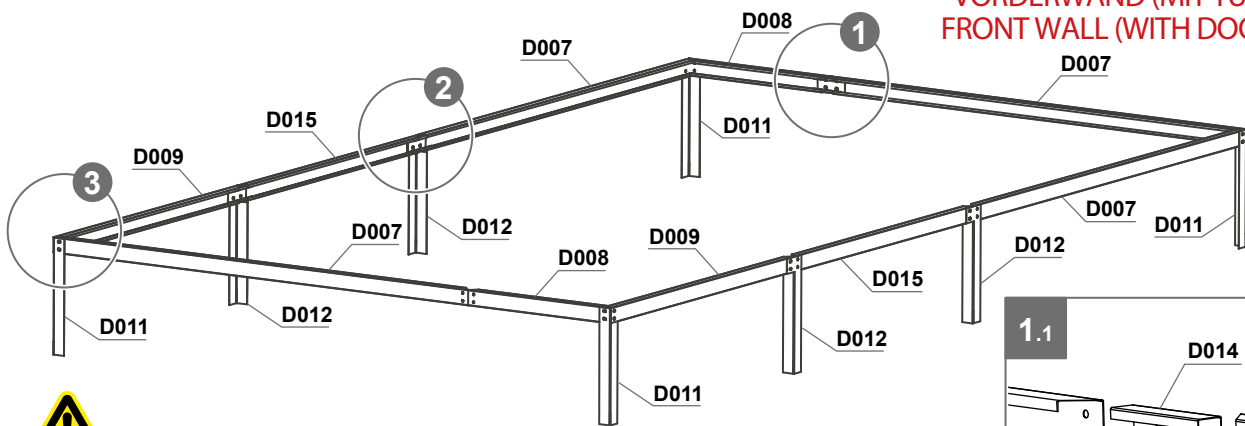
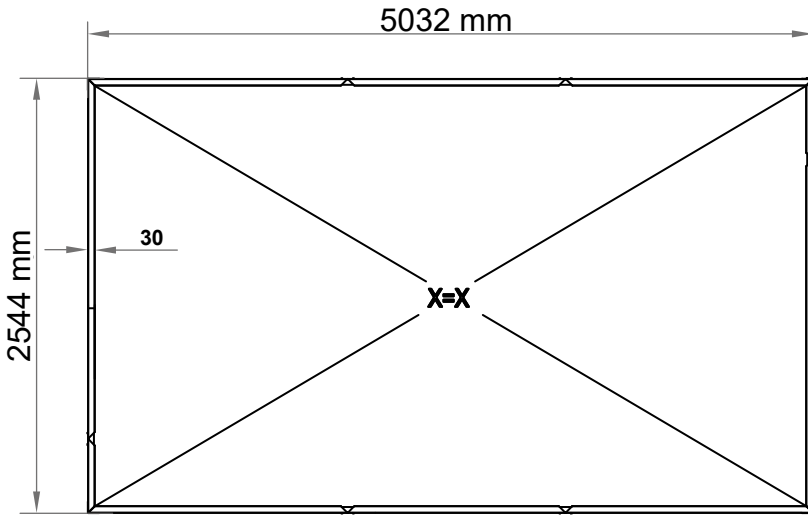

FACE AVANT (AVEC PORTE)
VORDERWAND (MIT TÜR)
FRONT WALL (WITH DOOR)



Plots béton / Punktfundament / Point foundation : D013 + D011 + D012.
Dalle ou pourtour béton / Streifenfundament / Concrete slab or frame : D013.

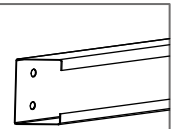

D007 x 4

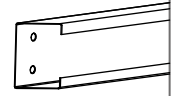

D008 x 2

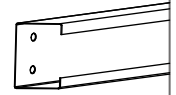

D009 x 2

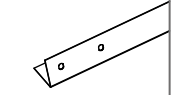

D011 x 4

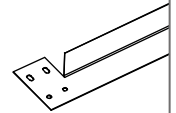

D012 x 2

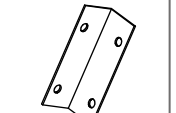

D013 x 4

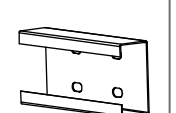

D014 x 4

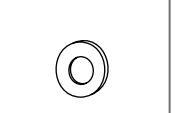

1008 x 32

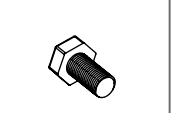

1009 x 32

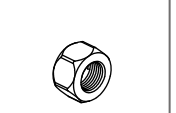

1010 x 32

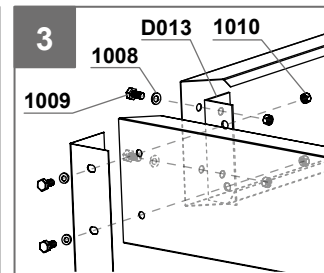
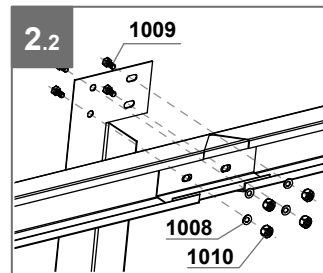
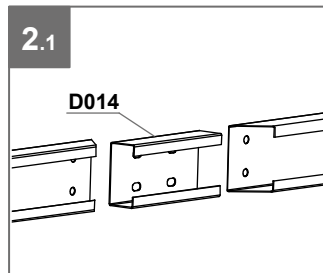
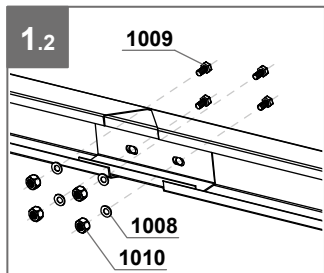

Module d'extension
Erweiterungsmodul
Extension module

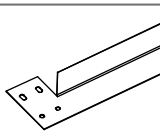

D012 x 2

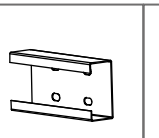

D014 x 2

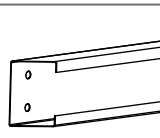

D015 x 2

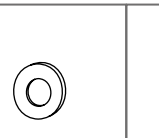

1008 x 8

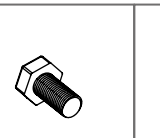

1009 x 8

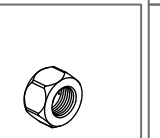

1010 x 8

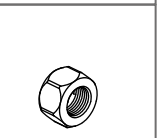

1010 x 32

FIXATION DE LA BASE AU SOL

FIXATION EN PLEINE TERRE

- Positionner la base à l'endroit voulu, de niveau sur un sol damé.
- Repérer l'emplacement des pattes de scellement suivant le schéma ci-dessous.
- Marquer un carré de 300 x 300 mm autour des pattes de scellement et creuser sur une profondeur de 450 mm.
- Placer la base, la mettre de niveau et remplir les trous de béton.

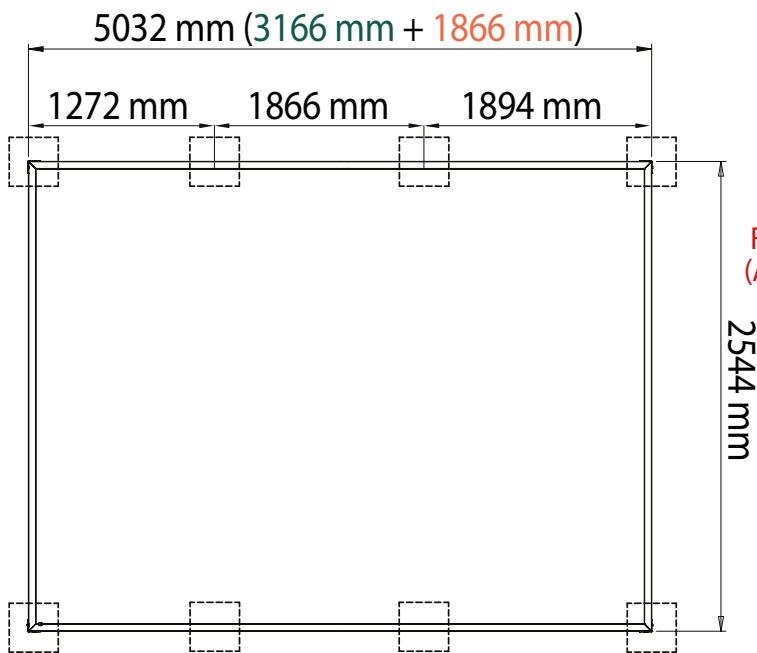

FACE AVANT
(AVEC PORTE)

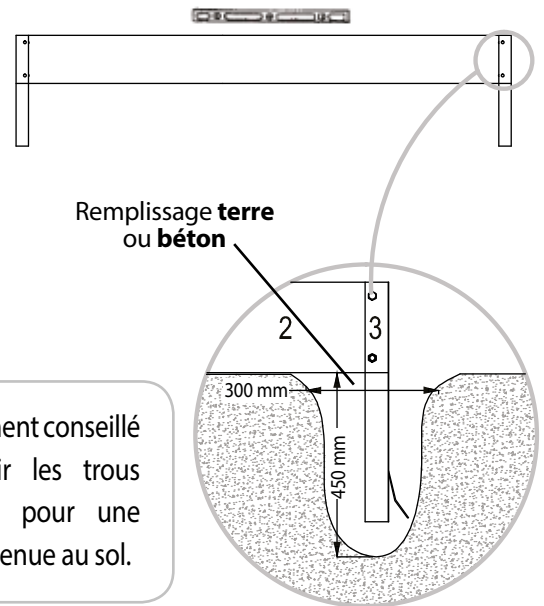

Il est vivement conseillé de remplir les trous de béton pour une meilleure tenue au sol.

OU

FIXATION SUR DALLE BÉTON

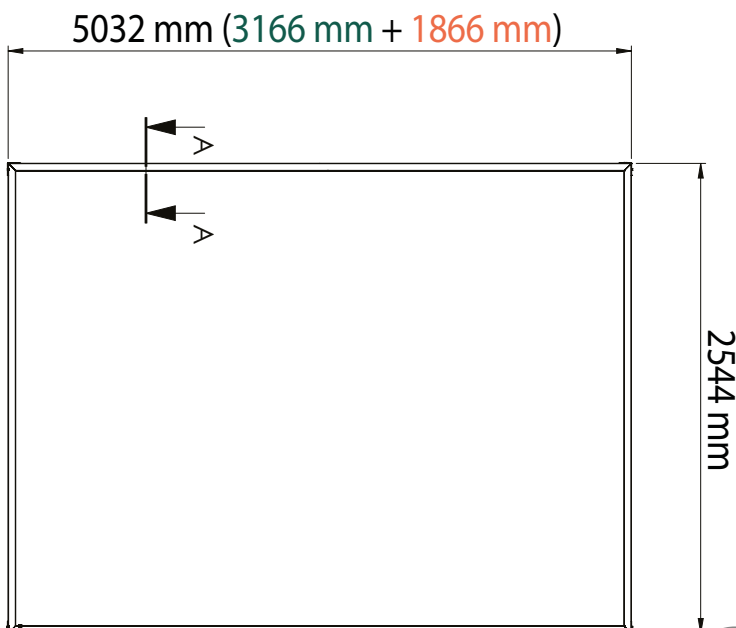

Détail A-A

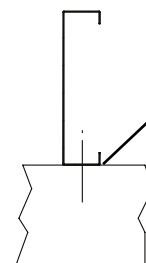

Fixation par chevilles à l'intérieur de la base



Visseries et chevilles de fixation non fournies

Il est laissé à votre libre choix et décision, l'utilisation des fixations adéquats selon les supports que vous décidez d'utiliser (pourtour bois, parpaings, plaques ciment, ...).



BEFESTIGUNG DES FUNDAMENTRAHMENS AM BODEN

BEFESTIGUNG AUF ERDBODEN (Punktfundament)

- Stellen Sie den Fundamentrahmen an der gewünschten Stelle, auf einem ebenen Boden.
- Finden Sie die Stelle der Ankerbeine gemäß dem untenstehenden Schema.
- Markieren Sie ein 300 x 300 mm Quadrat um die Ankerbeine herum und graben Sie 450 mm tief.
- Den Fundamentrahmen platzieren, nivellieren und die Löcher mit Beton füllen.

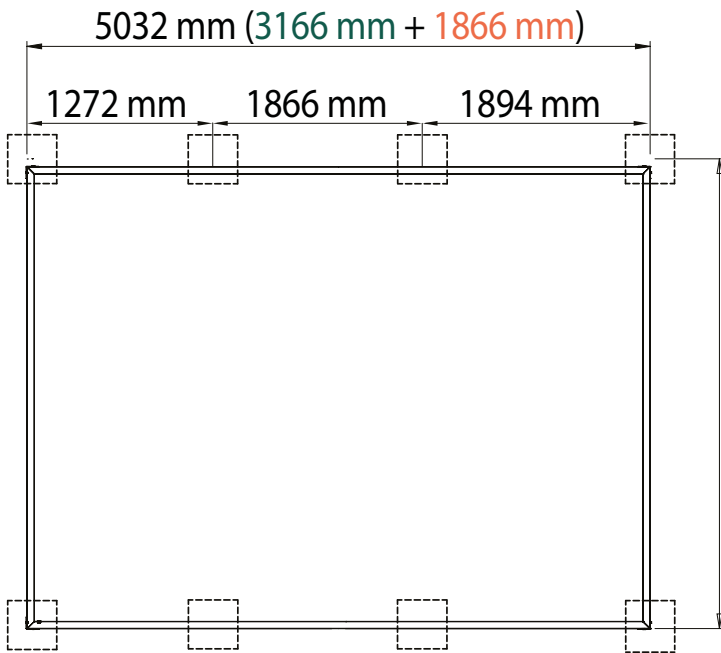

**VORDERWAND
(MIT TÜR)**

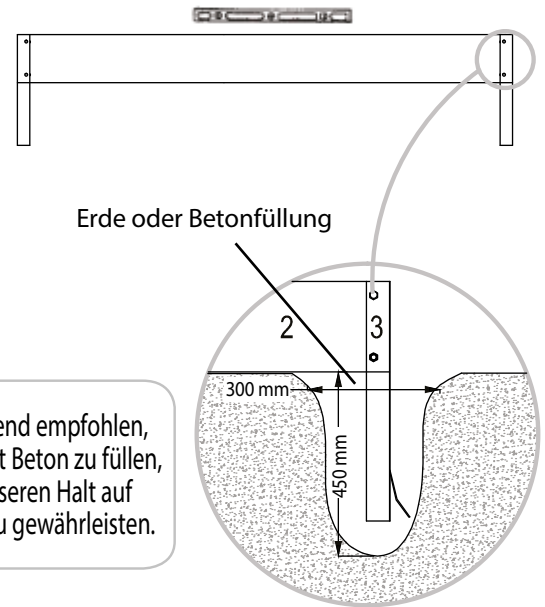

Es wird dringend empfohlen,
die Löcher mit Beton zu füllen,
um einen besseren Halt auf
dem Boden zu gewährleisten.

ODER

BEFESTIGUNG AUF BETONDECKE (Streifenfundament)

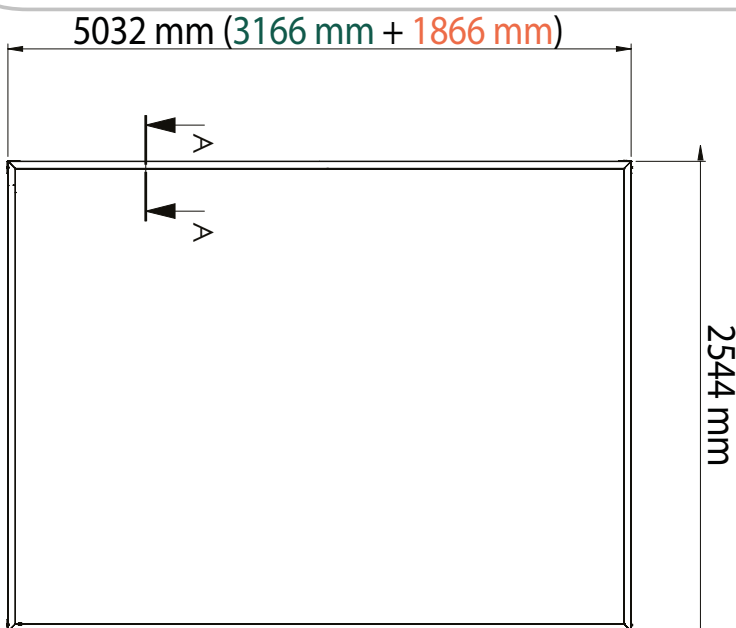

Detail A-A



**Schrauben und
Befestigungsdübel
nicht im Lieferumfang
enthalten**

Es bleibt Ihrer freien Wahl und Entscheidung
überlassen, die geeigneten Befestigungsmittel
entsprechend der von Ihnen gewählten Träger
(Holzumrandung, Bausteine, Zementplatten,...)
zu verwenden.



FIXING THE GREENHOUSE BASE TO THE GROUND

FIXING ON SOIL (POINT FOUNDATION)

- Position the greenhouse base in the desired location at a level position.
- Locate the base legs as shown bellow.
- Mark a 300 x 300 mm square around the base legs and dig 450 mm deep.
- Place the greenhouse base, level it and fill the holes with concrete.

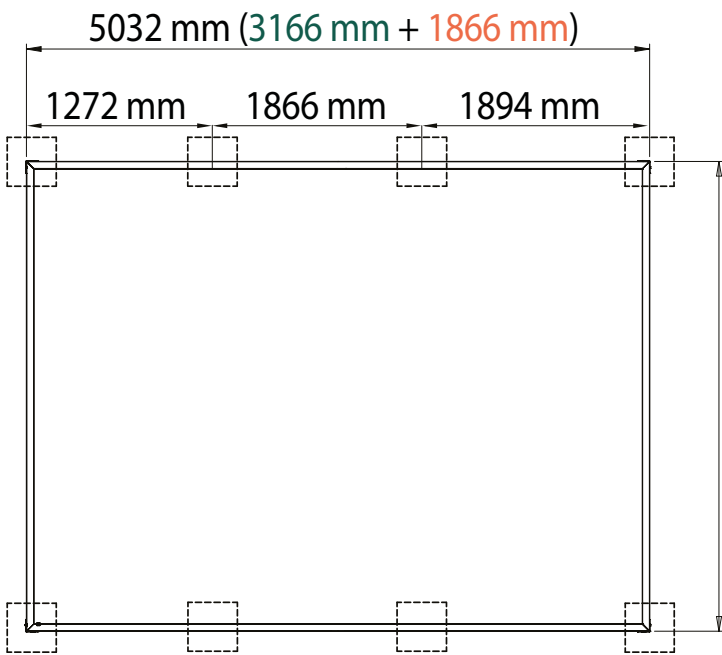

 **FRONT WALL (WITH DOOR)**

2544 mm

It is strongly recommended to fill the holes with concrete for a better hold on the ground.

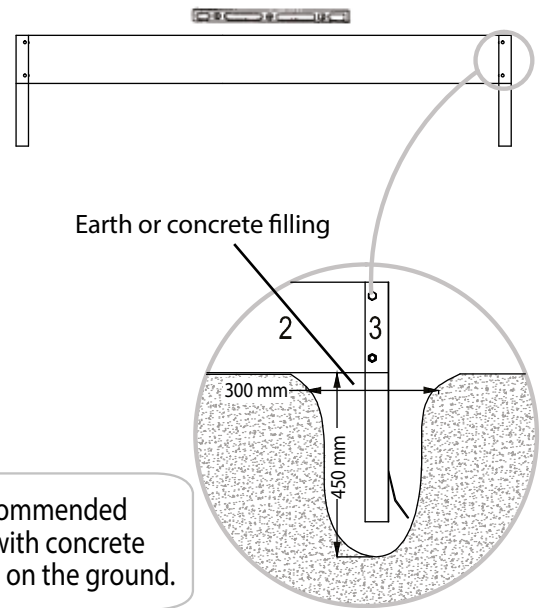

OR

FIXING ON CONCRETE SLAB

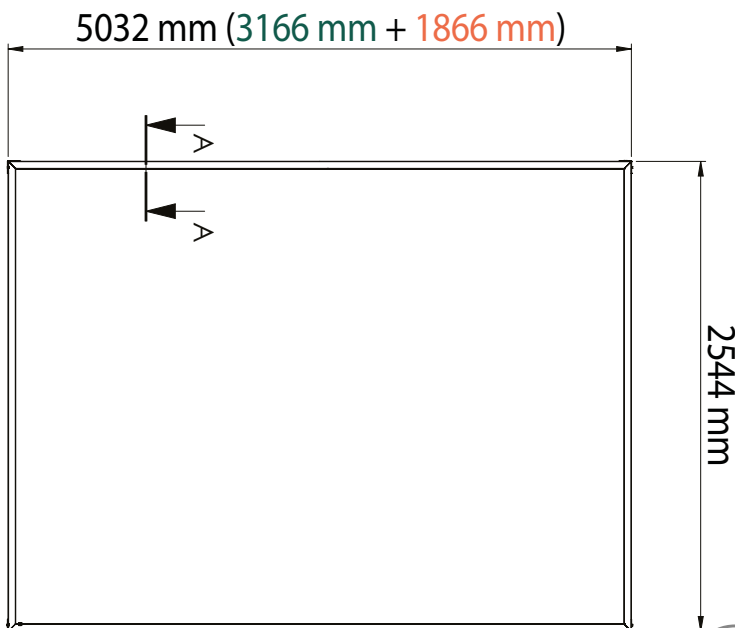

Detail A-A

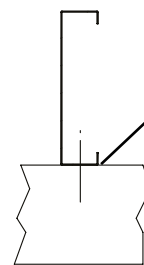

Rawplug fastening inside the greenhouse base



Screws and rawplugs not provided

It remains to your free choice and decision to use the suitable fastening means according to the supports you chose (wood border, building stones, cement plates etc.)

VIS 1002 & 1003 - SCHRAUBEN 1002 & 1003 - SCREWS 1002 & 1003

Mise en place des vis 1002 et 1003 dans les rainures en forme de T des profilés aluminium :
Entrez la tête de vis dans la rainure du profilé et tournez à 90° afin qu'elle ne puisse pas sortir du profilé. Assemblez la/les pièce(s) nécessaire(s) et serrez l'écrou.

Verwendung der Schrauben 1002 und 1003 in den t-förmigen Nuten der Aluminiumprofile :
Schraubenkopf in die Profilmutter stecken und diesen um 90° drehen, damit er nicht aus dem Profil herauskommt. Bauen Sie das/die benötigte(n) Einzelteil(e) zusammen und ziehen Sie die Schraubenmuttern an.

Principle of use of screws 1002 and 1003 in the T-shaped grooves of the aluminium profiles :
Enter the screw head into the groove of the profile and turn the screw head at 90° so that it cannot exit the profile. Assemble the required part(s) and tighten the screw nut.

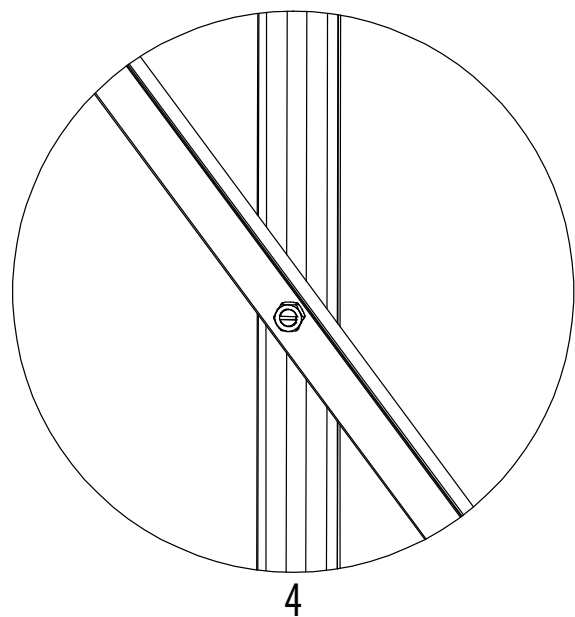
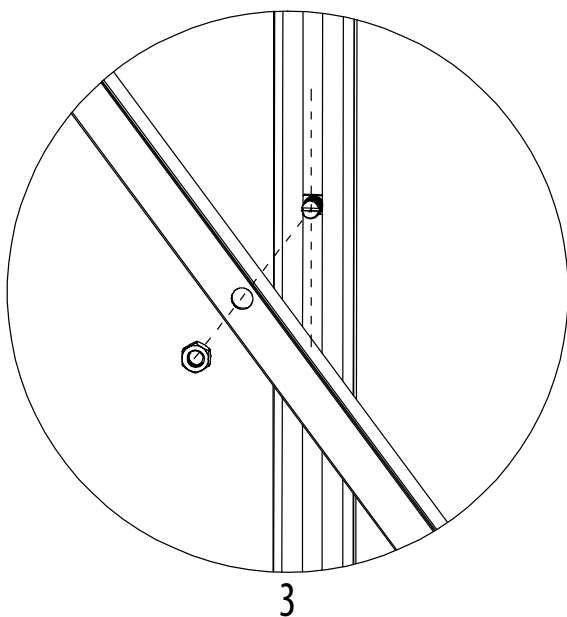
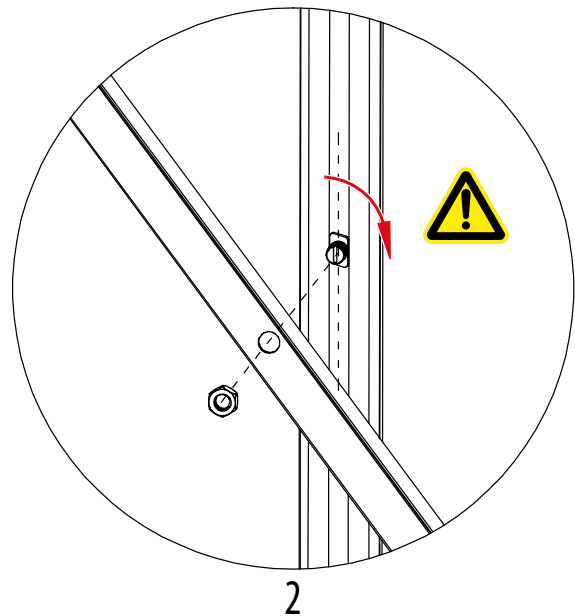
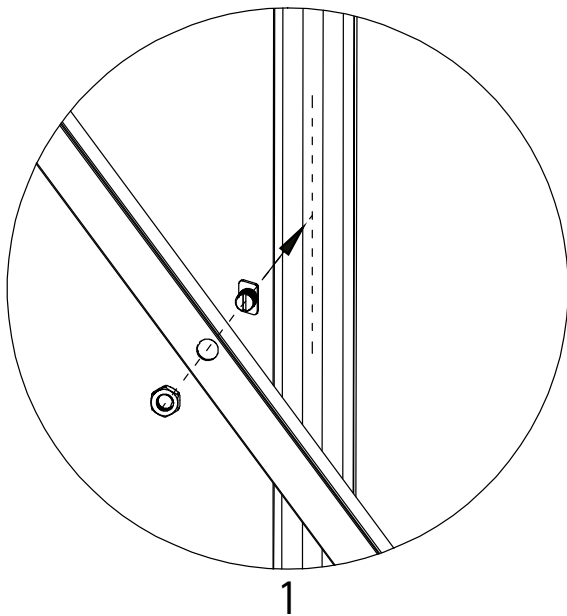

LONG-PAN (CÔTÉ) - SEITENWAND - SIDE WALL

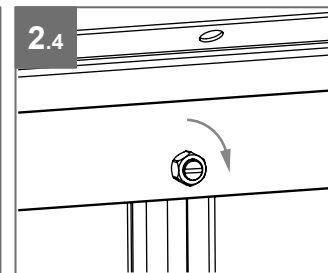
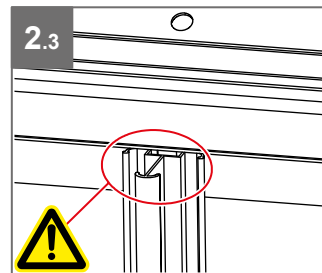
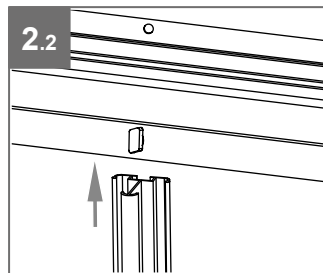
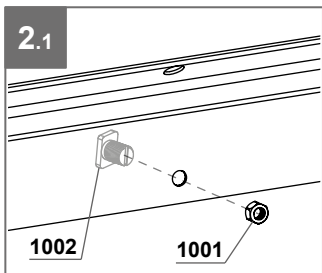
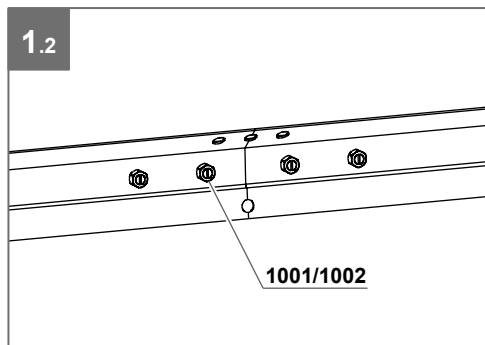
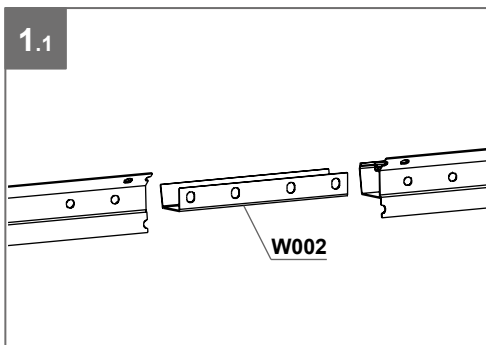
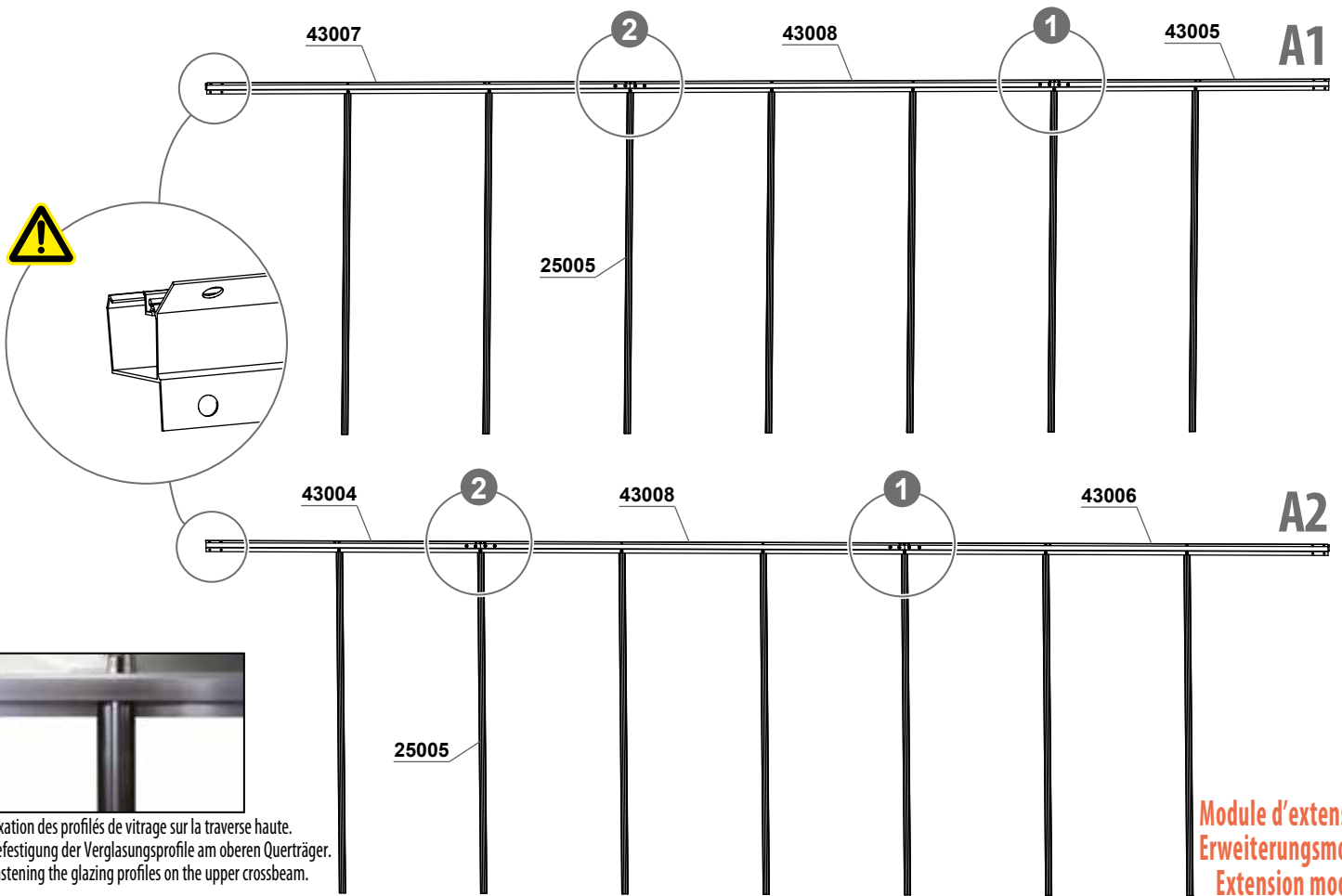

	25005 x 6
	43008 x 2
	W002 x 2
	1001 x 14
	1002 x 14

Module de base Basismodul Basic module

25005 x 8	43004 x 1	43005 x 1	43006 x 1	43007 x 1	W002 x 2	1001 x 16	1002 x 16

LONG-PAN (CÔTÉ) - SEITENWAND - SIDE WALL

Module d'extension
Erweiterungsmodul
Extension module

A1

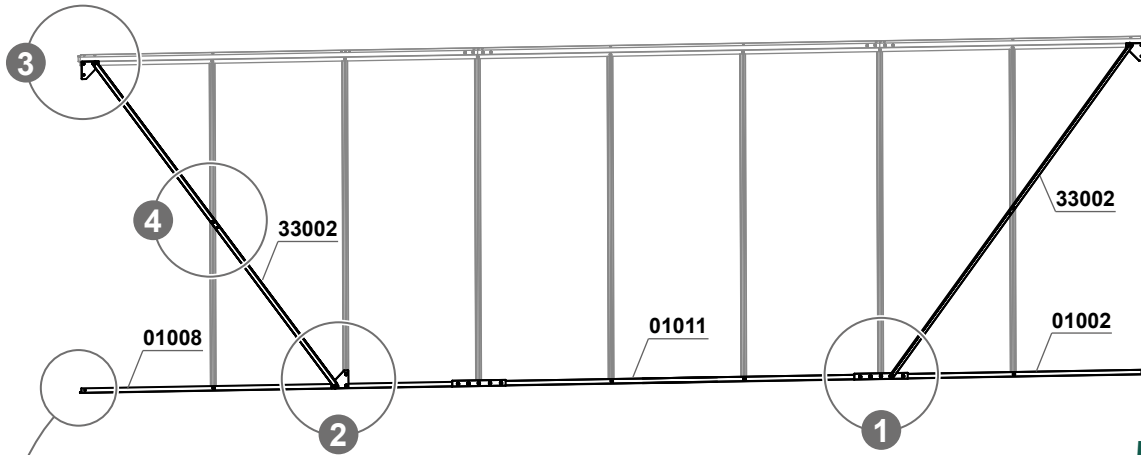

A2

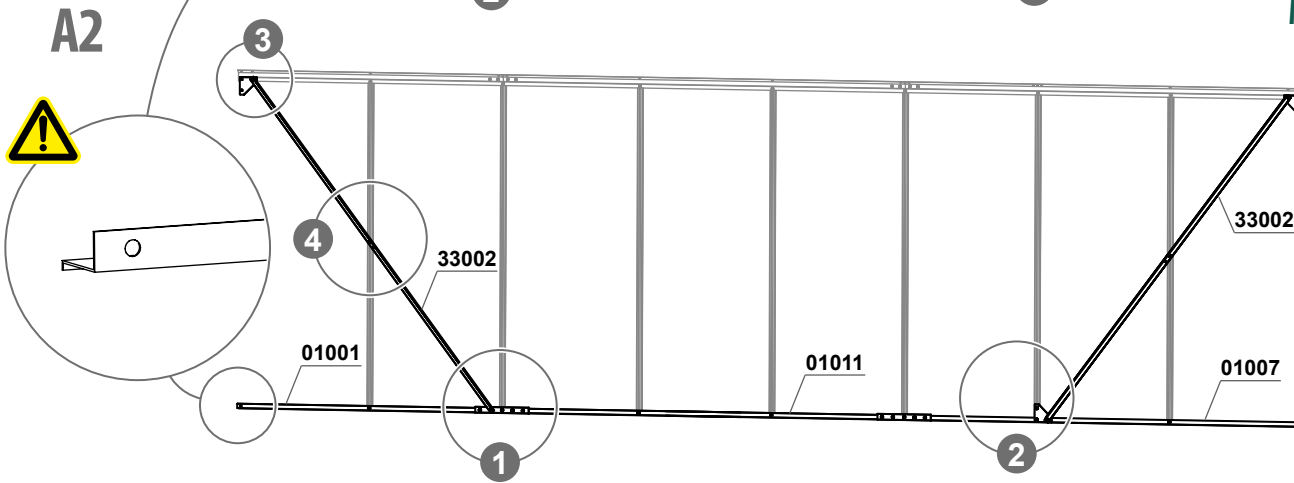

Module de base
Basismodul
Basic module

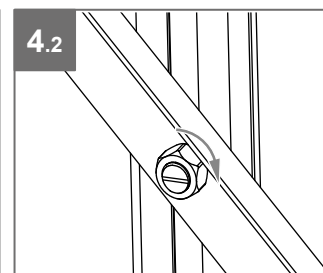
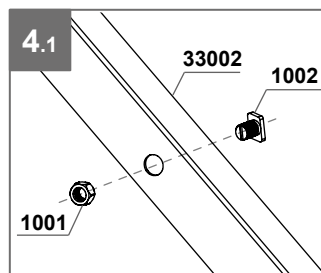
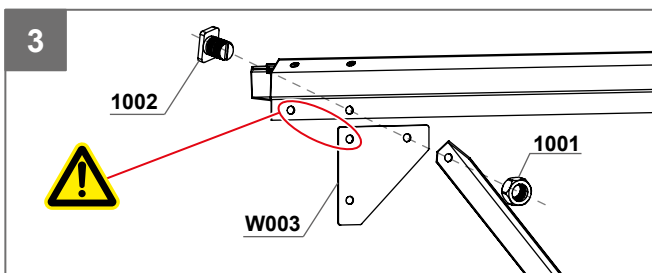
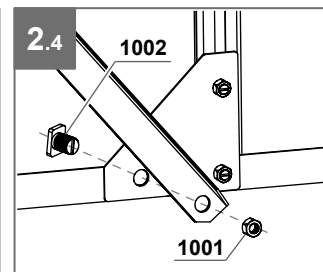
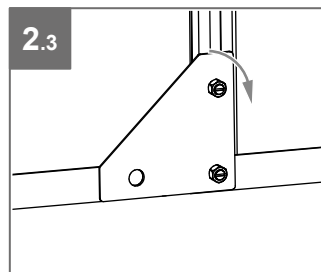
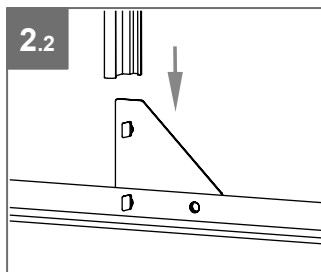
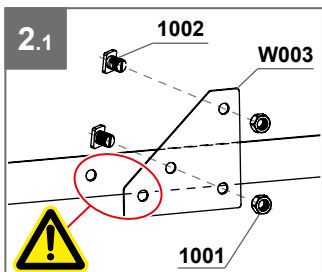
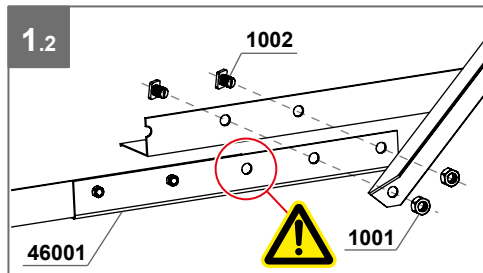
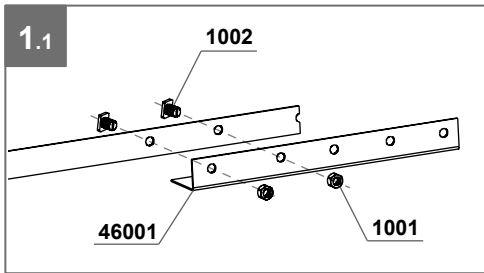
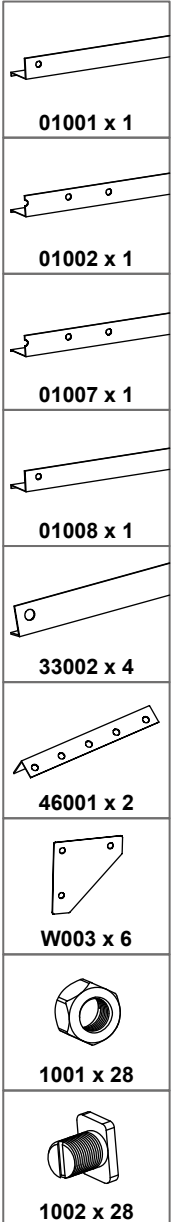
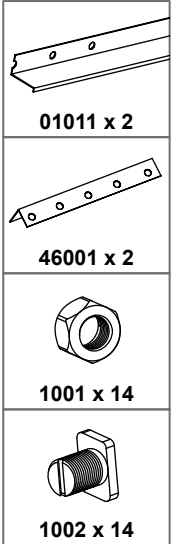

ÉTAPES SUIVANTES - NÄCHSTE SCHRITTE - NEXT STEPS

Montage de la face avant (avec porte) : pages 17-19
Montage der Vorderwand (mit Tür) : Seite 17-19
Assembling the front wall (with door) : pages 17-19

Montage de la face arrière (sans porte) : pages 20-22
Montage der Rückwand (ohne Tür) : Seite 20-22
Assembling the rear wall (without door) : pages 20-22

Montage de la porte : pages 23-24
Montage der Tür : Seite 23-24
Assembling the door : pages 23-24

Montage de la lucarne : page 25
Montage des Fensters : Seite 25
Assembling the window : page 25

Puis revenir à la page 64
Dann zurück auf Seite 64
Then back to page 64

ASSEMBLAGE DES PAROIS - ZUSAMMENBAU DER WÄNDE

ASSEMBLY OF THE WALLS

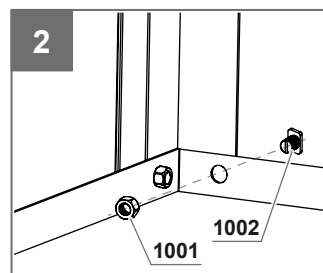
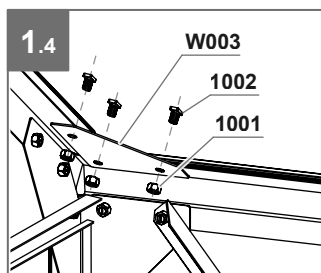
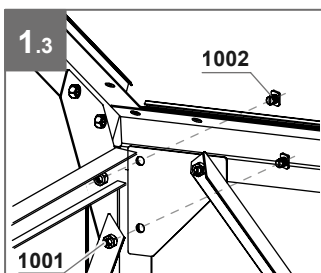
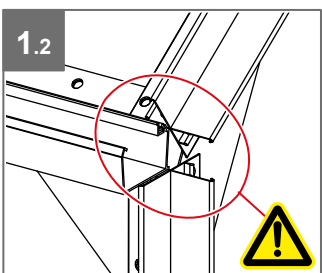
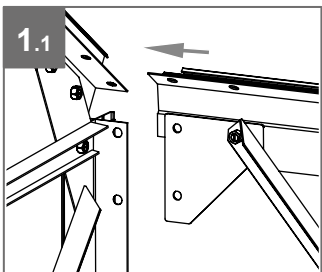
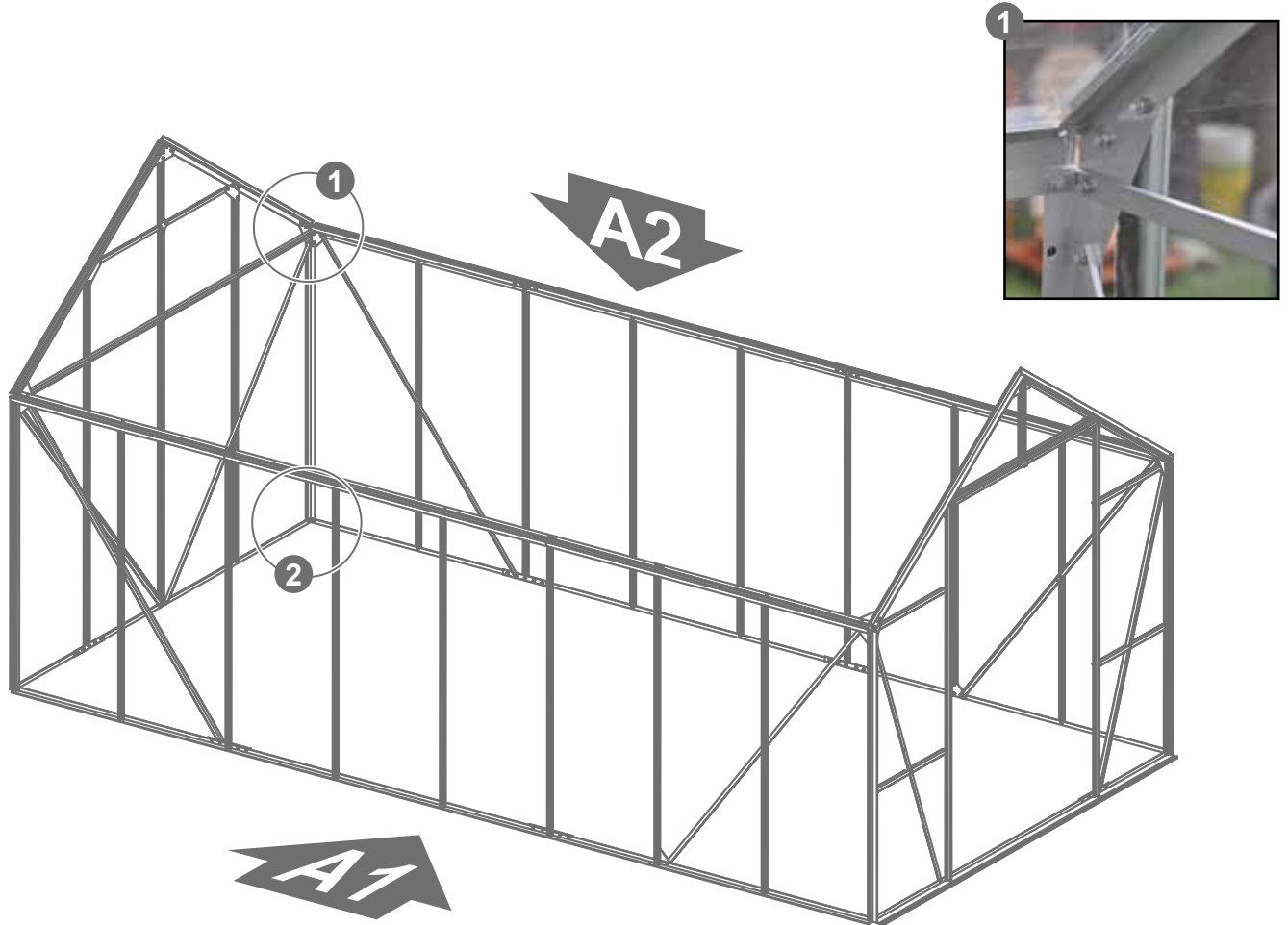

Module de base
Basismodul
Basic module

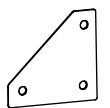

W003 x 4



1001 x 24



1002 x 24

MONTAGE DES PROFILÉS DE TOITURE - MONTAGE DER DACHPROFILE ASSEMBLING THE ROOF PROFILES

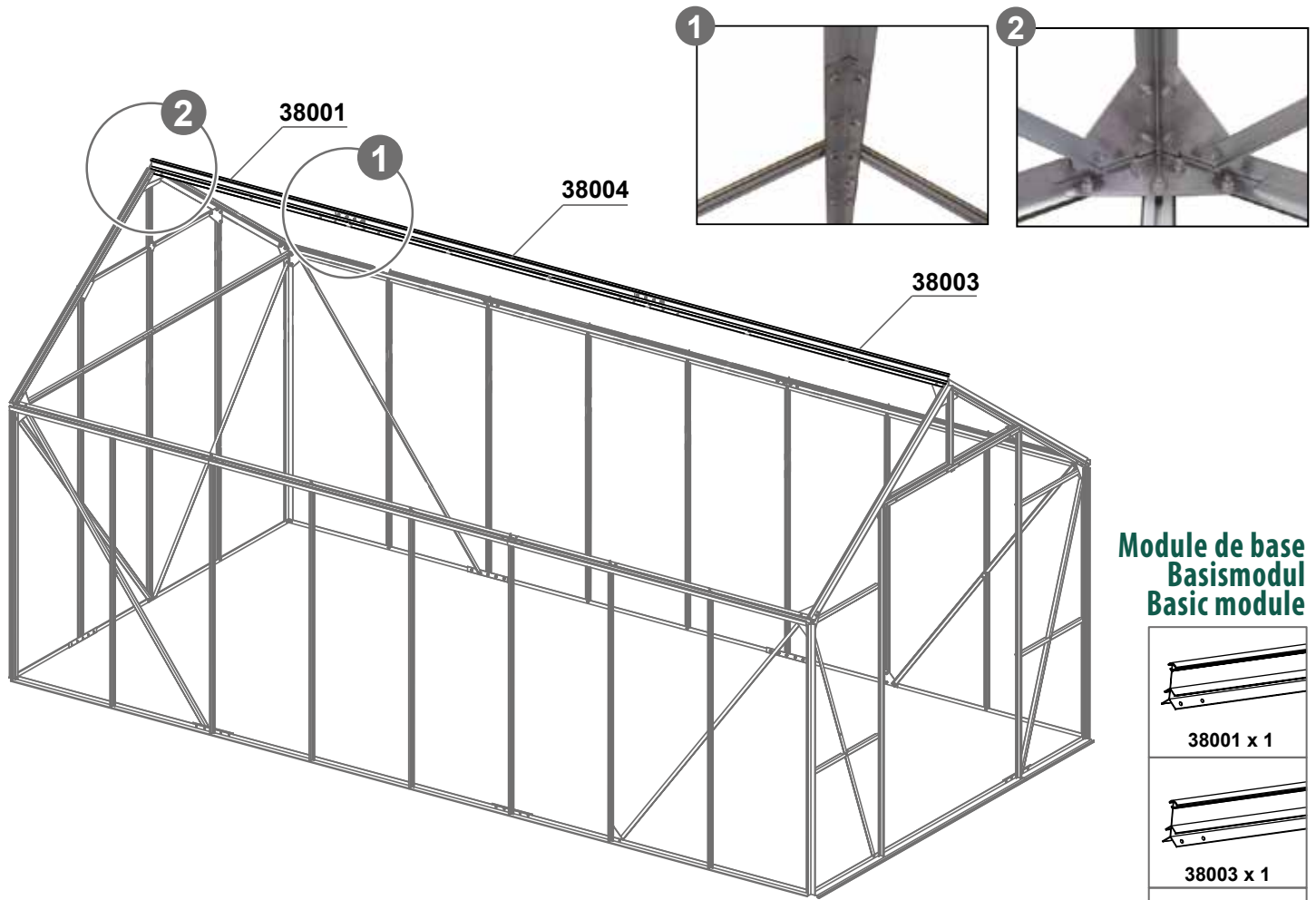

Module de base Basismodul Basic module

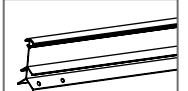

38001 x 1

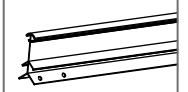

38003 x 1

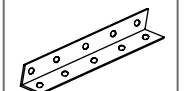

45001 x 1

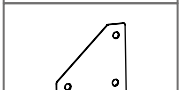

W003 x 4

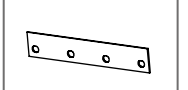

W004 x 2

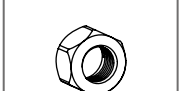

1001 x 20

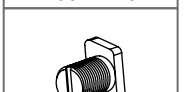

1002 x 12



1011 x 8

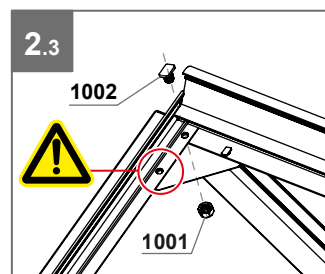
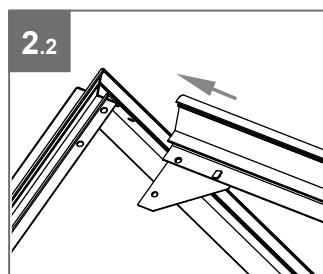
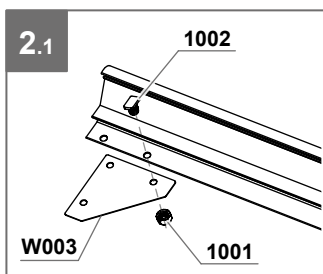
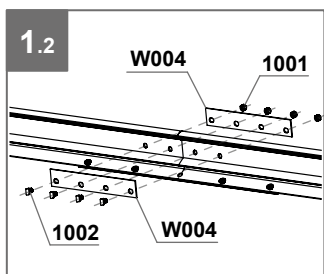
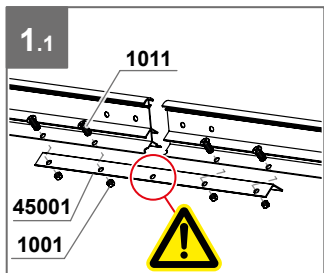

Module d'extension Erweiterungsmodul Extension module

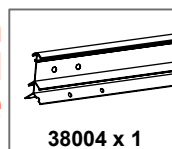

38004 x 1

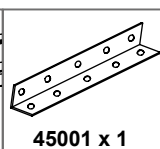

45001 x 1

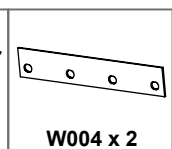

W004 x 2

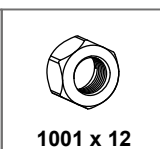

1001 x 12

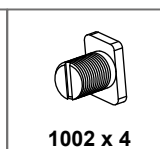

1002 x 4

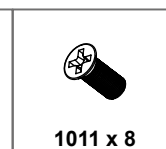

1011 x 8



1011 x 8

MONTAGE DES PROFILÉS DE TOITURE - MONTAGE DER DACHPROFILE ASSEMBLING THE ROOF PROFILES

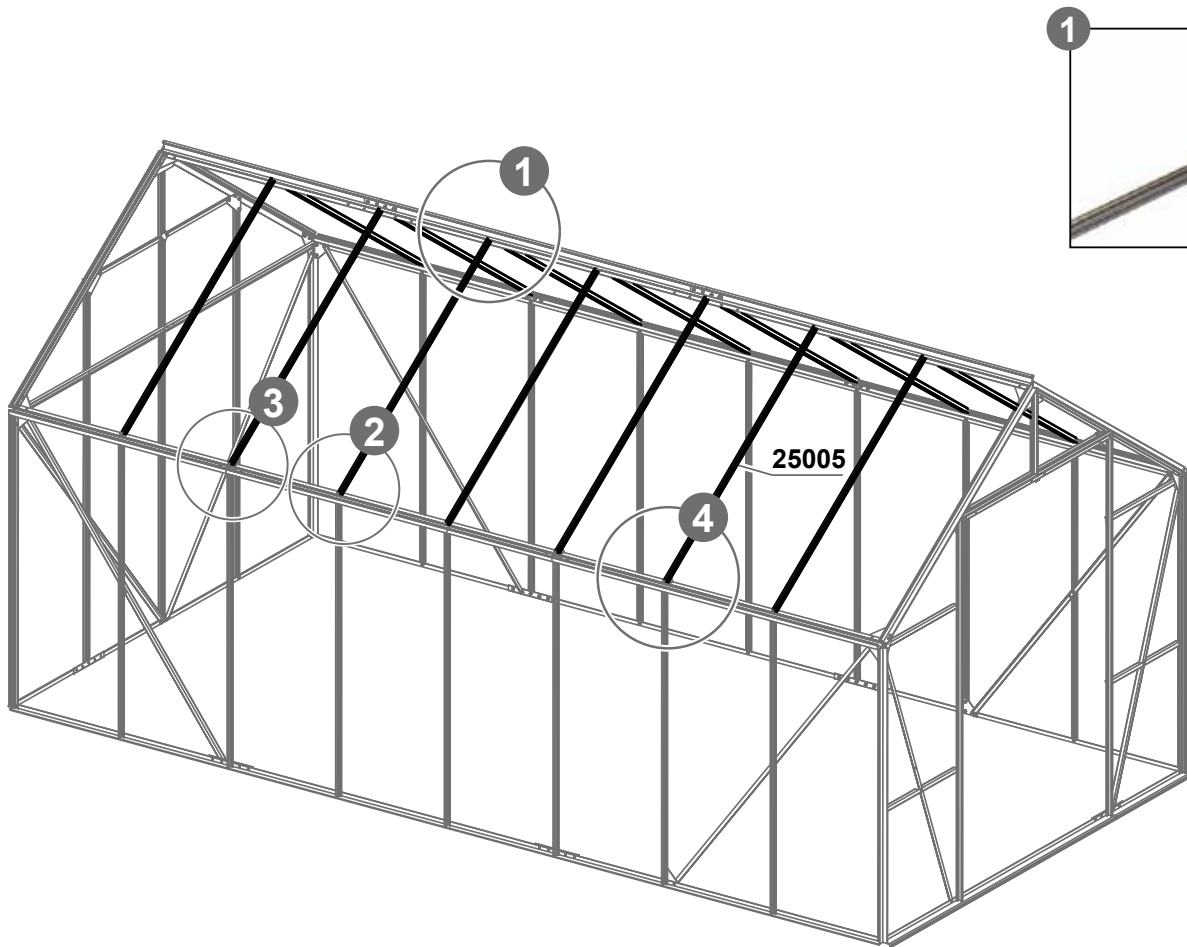

Module de base
Basismodul
Basic module

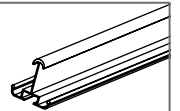

25005 x 8

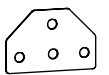

W005 x 2

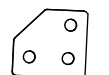

W020 x 2



1001 x 20



1002 x 20

Module d'extension
Erweiterungsmodul
Extension module

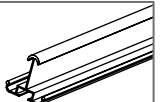

25005 x 6

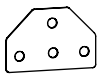

W005 x 2



1001 x 18



1002 x 18

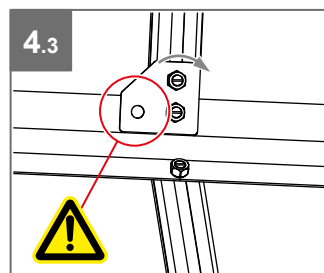
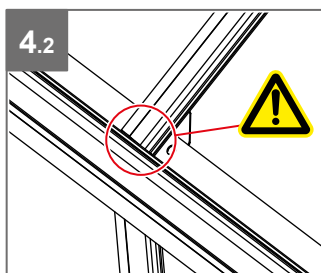
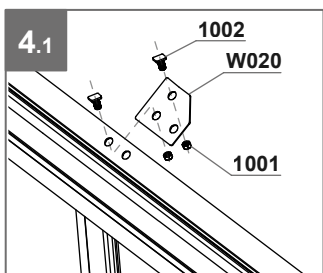
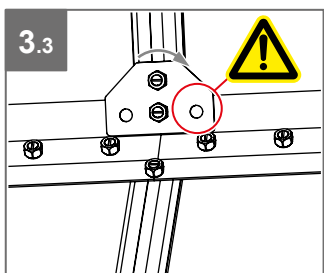
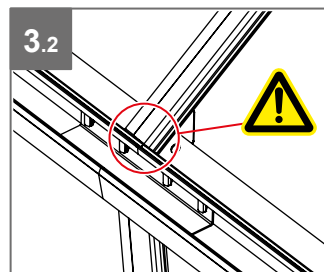
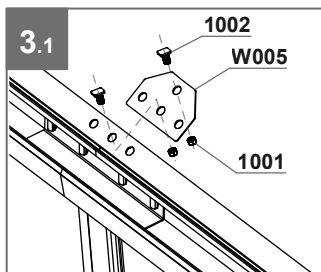
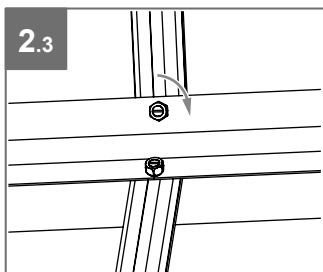
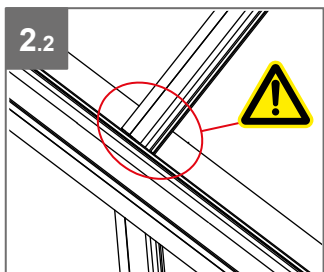
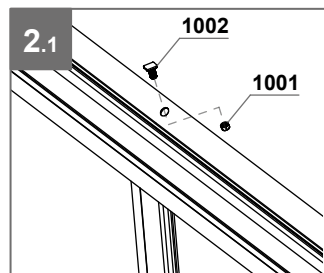
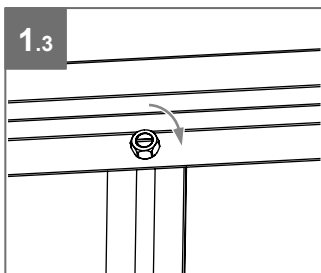
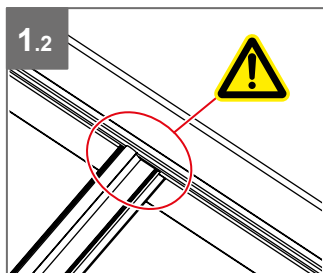
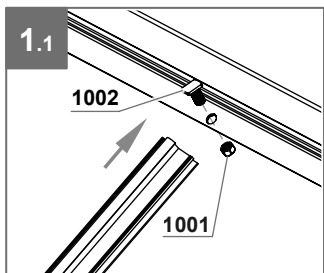

MONTAGE DES TENDEURS ET GOUSSETS SPANNVORRICHTUNG UND VERBINDER WIND BRACES AND GUSSETS

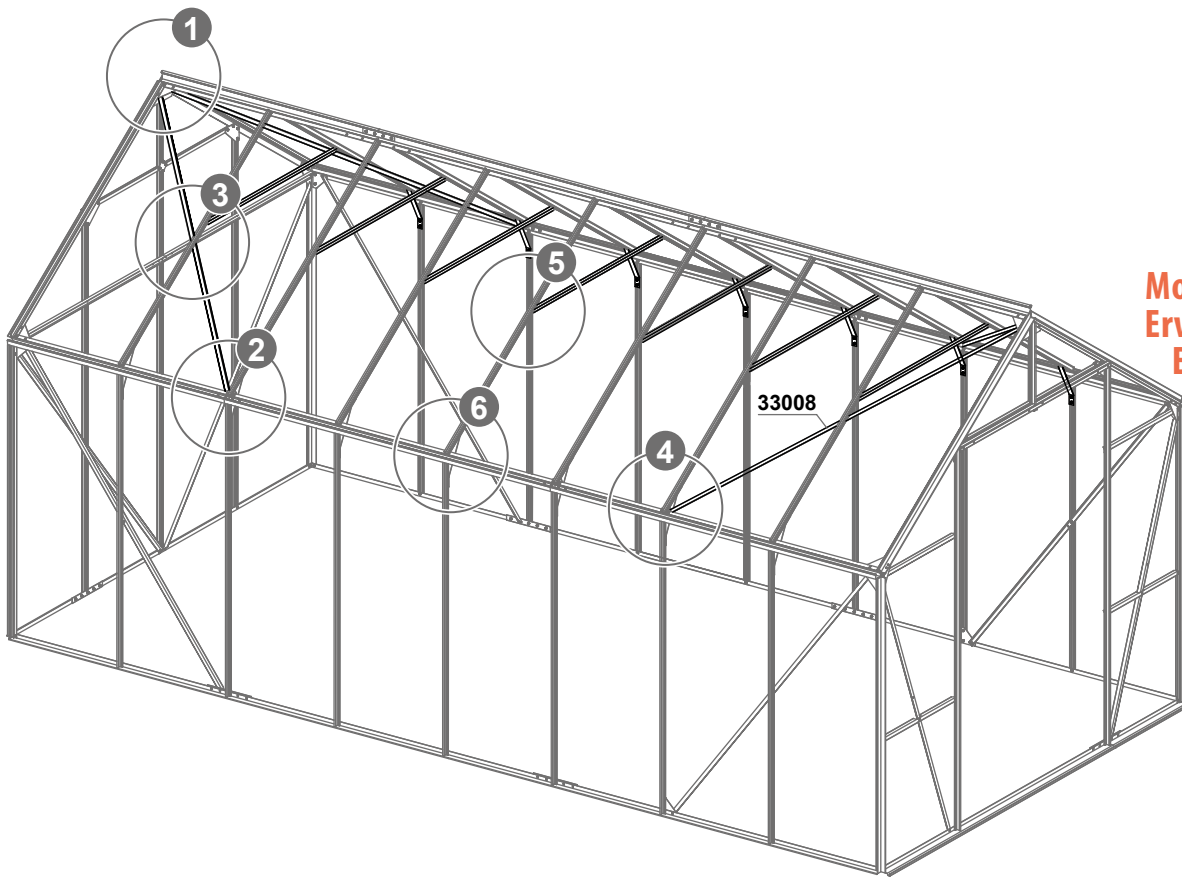

Module d'extension
Erweiterungsmodul
Extension module

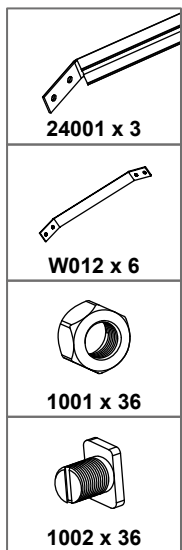

Module de base
Basismodul
Basic module

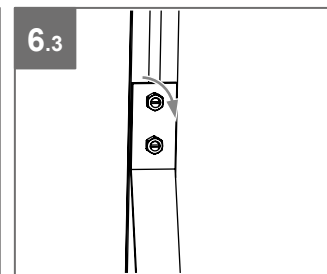
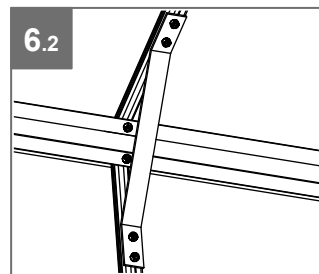
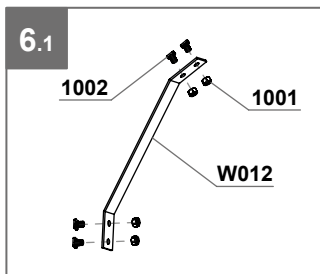
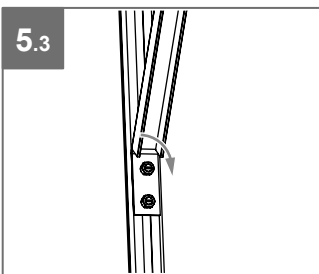
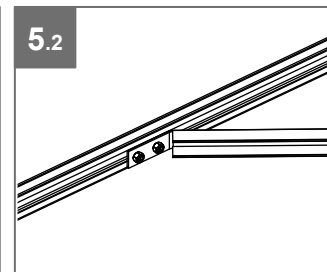
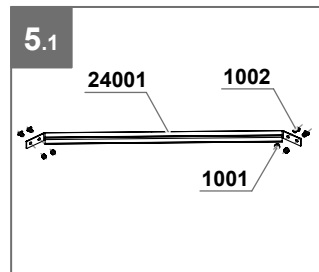
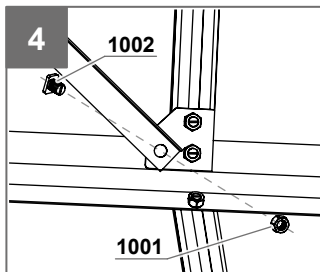
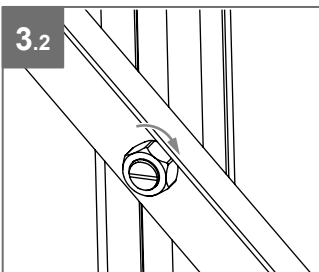
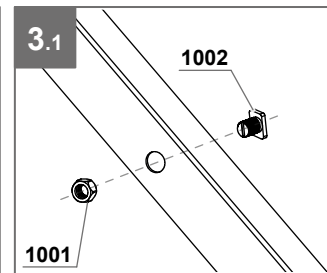
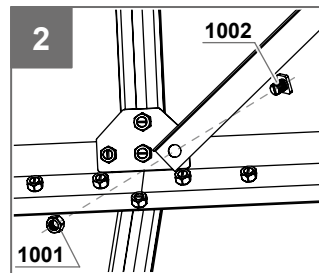
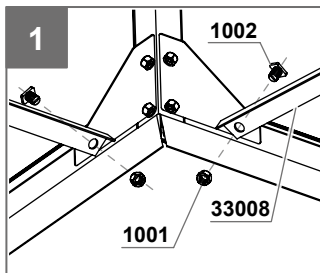
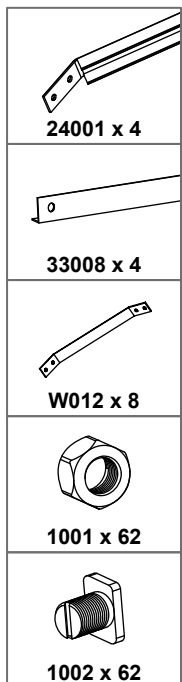

FIXATION DE LA SERRE SUR LA BASE BEFESTIGUNG DES GEWÄCHSHAUSES AM FUNDAMENTRAHMEN FASTENING THE GREENHOUSE BASE

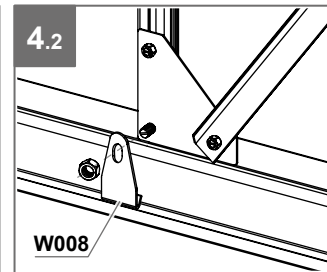
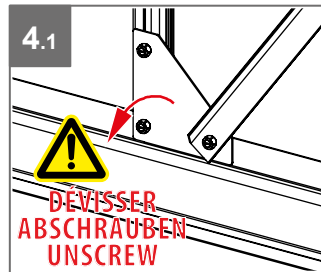
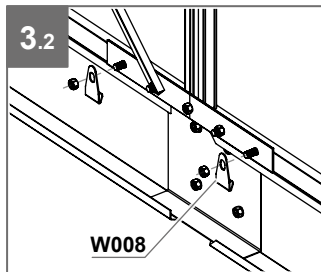
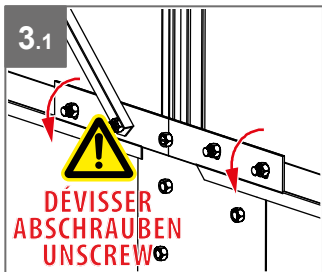
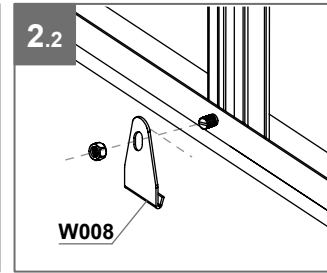
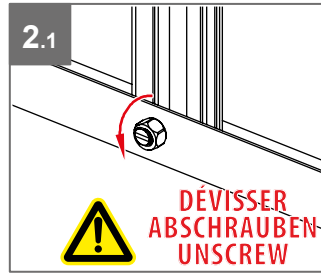
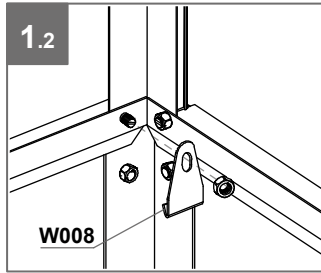
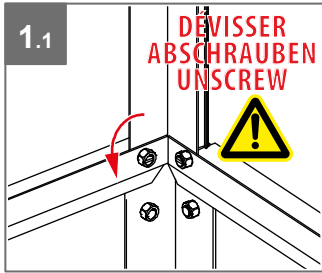
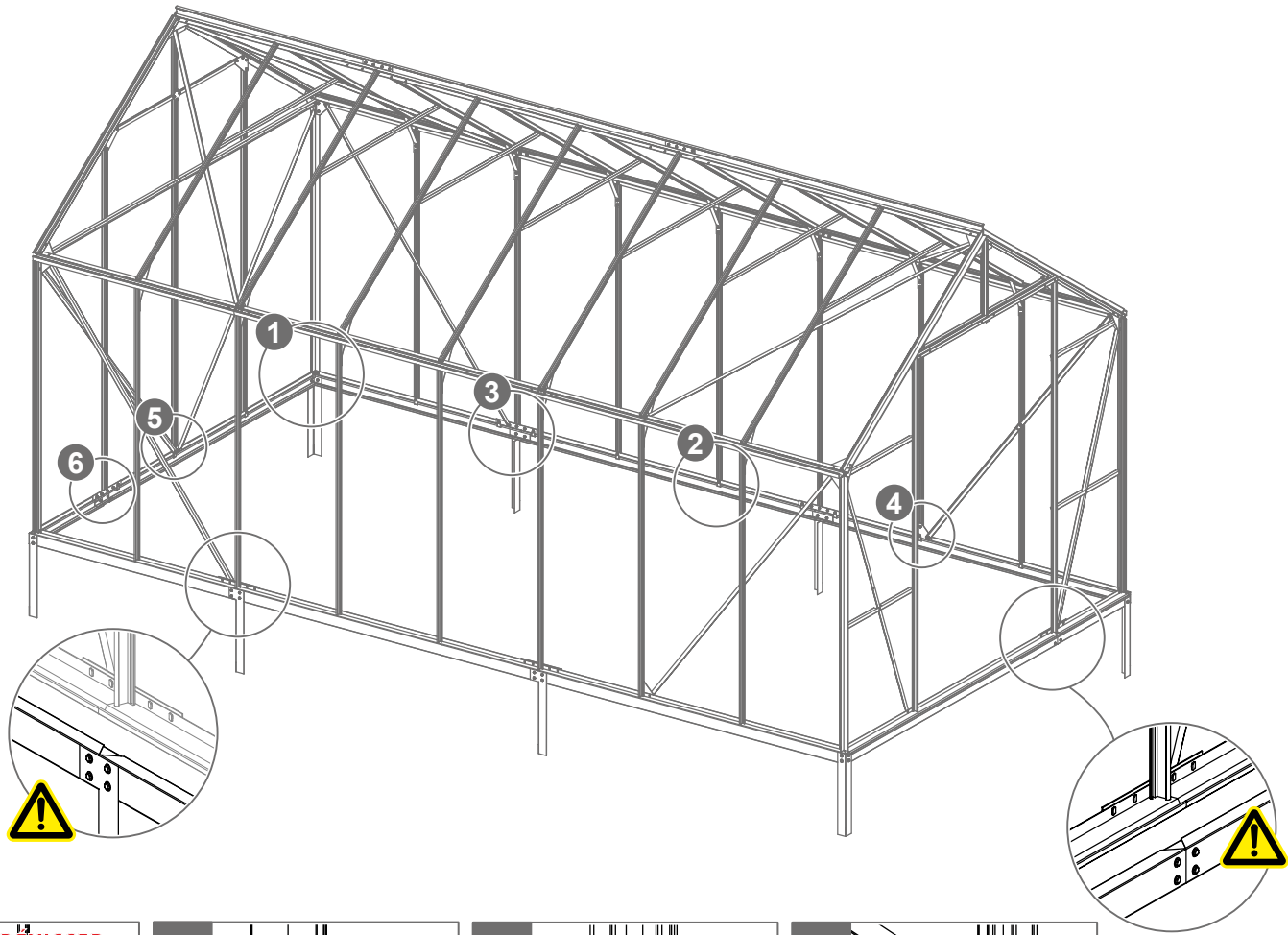

Module d'extension
Erweiterungsmodul
Extension module

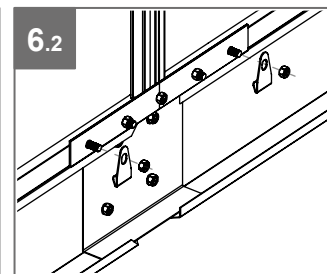
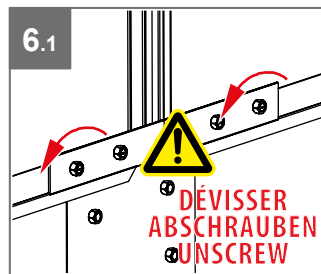
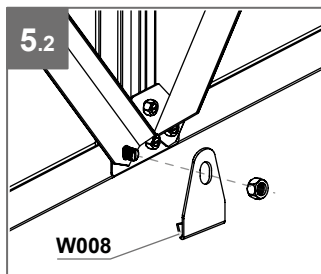
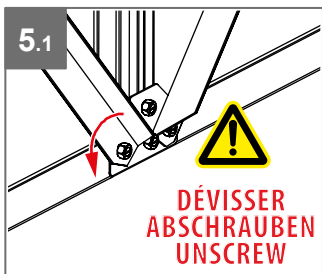
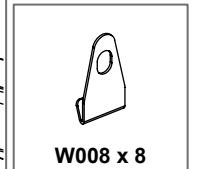

Module de base
Basismodul
Basic module



MONTAGE PORTE + RAIL MONTAGE TÜR + SCHIENE ASSEMBLING DOOR + RAIL



Rail de porte - Schiene - Rail



Haut de porte - Oberer Türbereich - Upper door area

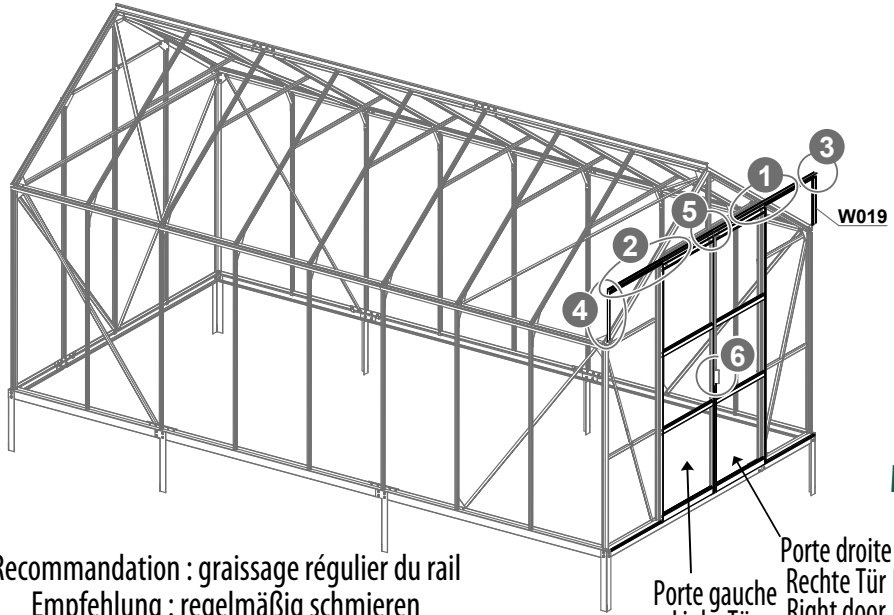

Recommandation : graissage régulier du rail
Empfehlung : regelmäßig schmieren
Recommendation : grease regularly

Module de base
Basismodul
Basic module

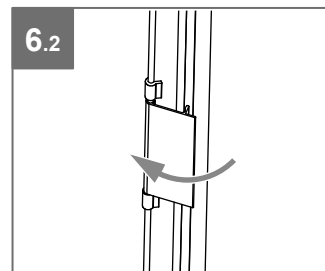
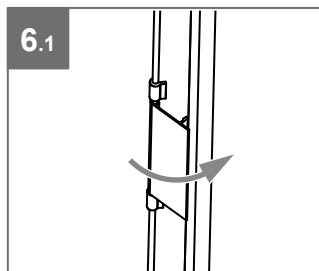
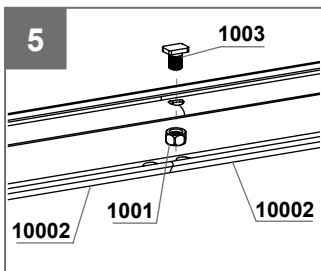
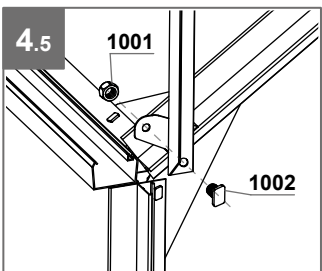
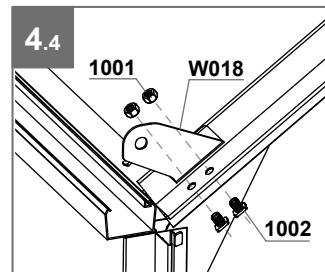
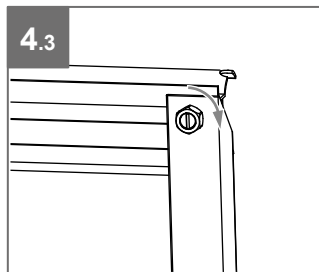
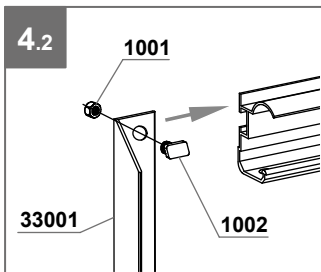
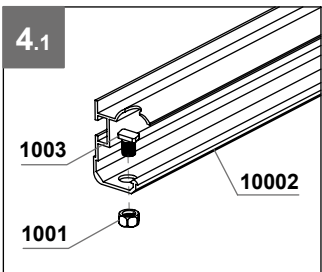
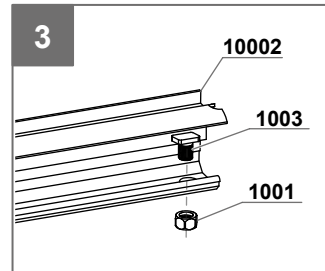
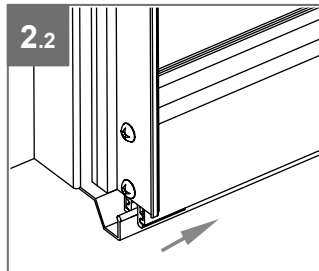
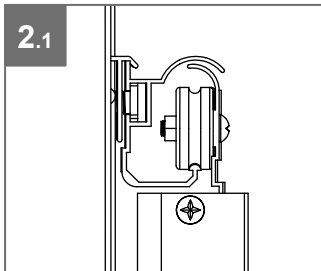
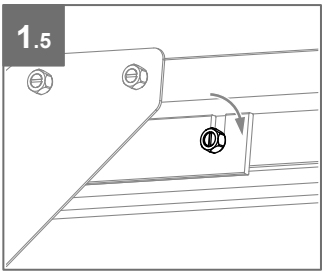
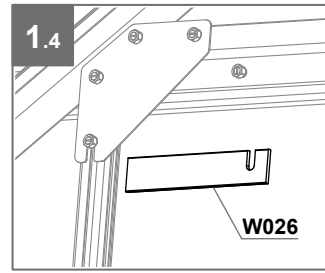
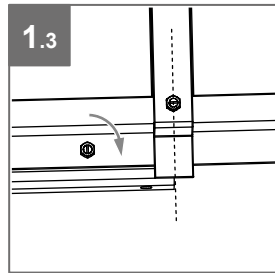
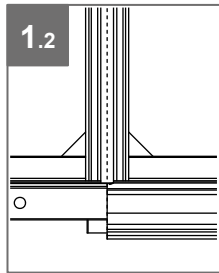
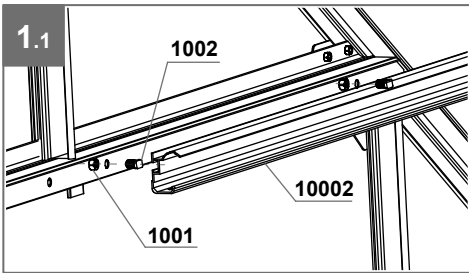

10002 x 2



33001 x 2



W018 x 1

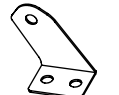

W019 x 1



1001 x 15

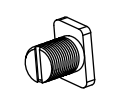

1002 x 12
1003 x 3

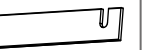

W026 x 2

VITRAGE - VERGLASUNG - GLAZING



Nous vous conseillons d'installer les verres niveau par niveau (du bas vers le haut).
 Wir empfehlen Ihnen, die Gläser Ebene für Ebene anzubringen (von unten nach oben).
 We advise you to install the glazing level by level (from bottom to top).



Crochets de vitrage
 Verglasungshaken
 Glazing hooks



Clips de vitrage
 Gewächshausklammern
 Glazing clips

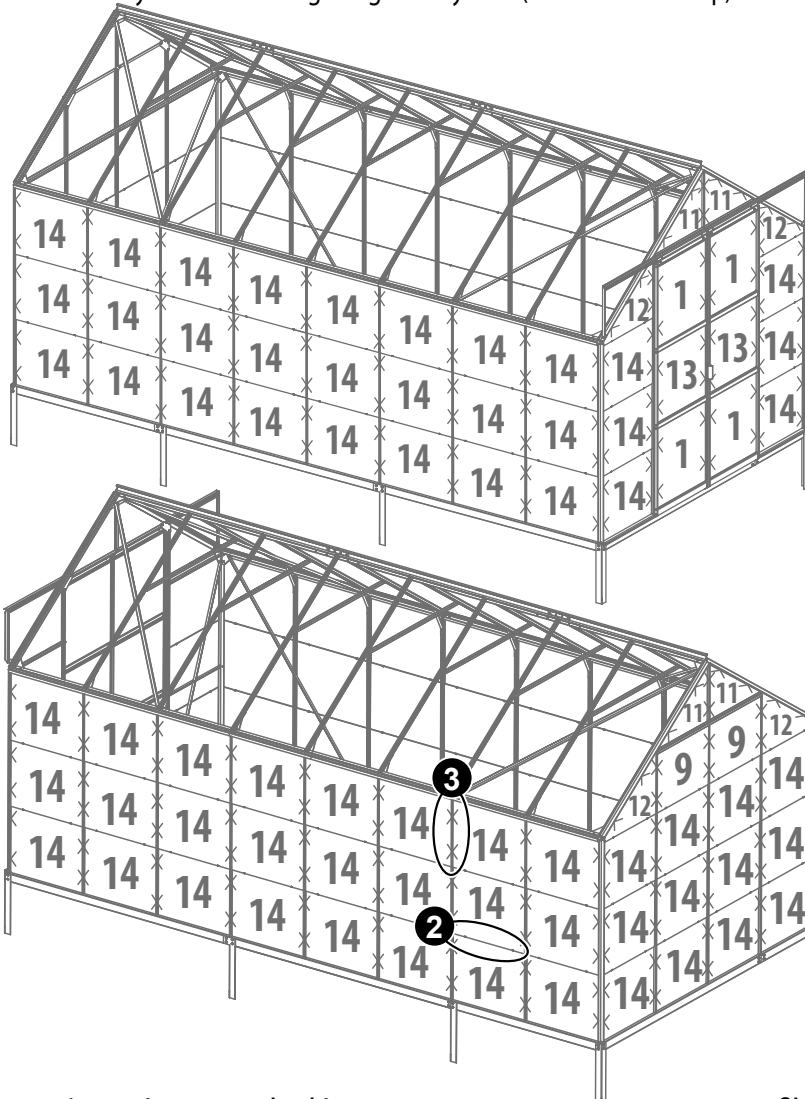

Module de base Basismodul Basic module

1

Pose du joint. Voir page 31.
 Puis continuez.
 Dichtung anbringen (s. S. 31).
 Dann fortfahren.
 Attach seal (s. p. 31).
 Then continue.

2

W006

3

W007

610 x 610	
1 x 4	
610 x 461	
9 x 2	
610 x 434/8	
11 x 4	
610 x 468/44	
12 x 4	
610 x 540	
13 x 2	
610 x 509	
14 x 48	

Il peut être nécessaire de dévisser temporairement certains profilés pour la mise en place des verres.

Resserer correctement les vis après la pose des verres.

Zum Anbringen der Gläser kann es erforderlich sein, bestimmte Profile vorübergehend abzuschrauben. Schrauben Sie diese nach der Anbringung der Gläser wieder fest.

Some profiles may need to be temporarily unscrewed to install the glazing. Refix the screws correctly after installing the glazing.

Module d'extension Erweiterungsmodul Extension module

610 x 509			
14 x 18	2006 x 37m	W006 x 24	W007 x 72

2006 x 105m	W006 x 76	W007 x 256

VITRAGE + POSE LUCARNE VERGLASUNG + FENSTER EINBAUEN GLAZING + INSTALLING WINDOW



Lucarne - vue extérieure
Fenster - Außenansicht
Window - exterior view

Module de base Basismodul Basic module



1
Pose de la lucarne sur faîtière
par glissement.
Anbringung des Fensters auf
First durch Gleiten.
Installing the window on
roof ridge through sliding.

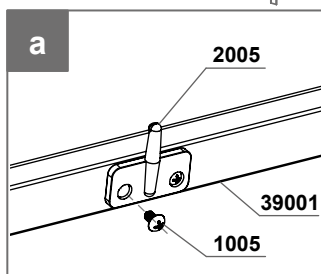
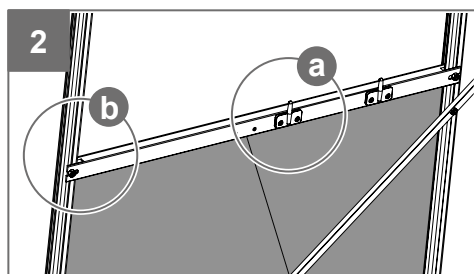
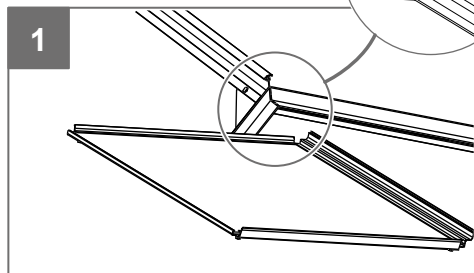
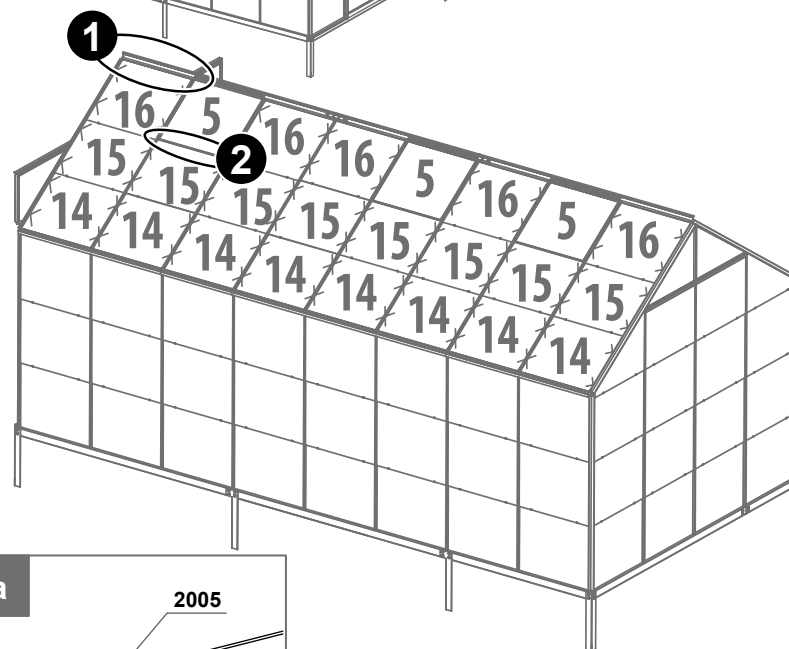
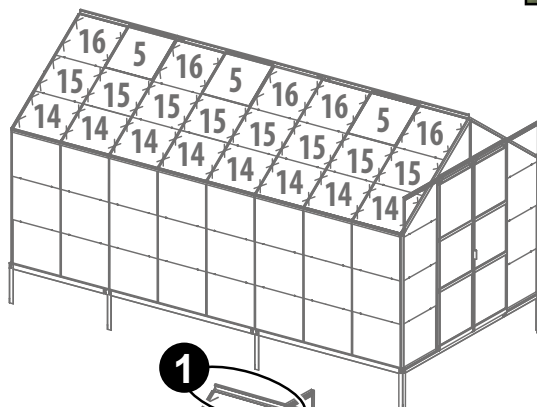

b.1
Couper le joint pour
passage de la pièce 39001

Dichtung schneiden um Einzelteil 39001 durchzulassen
Cut the seal to let part 39001 through

Module d'extension Erweiterungsmodul Extension module

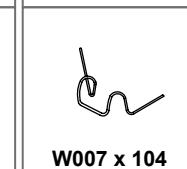
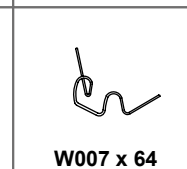
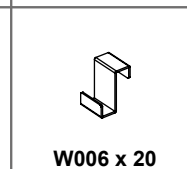
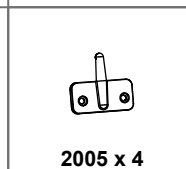
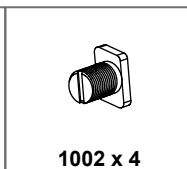
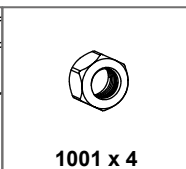
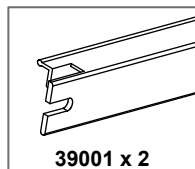

610 x 509 14 x 10	610 x 487 15 x 10	610 x 549 16 x 6	39001 x 4	1001 x 8	1002 x 8	1005 x 16	2005 x 8	W006 x 32	W007 x 104
----------------------	----------------------	---------------------	-----------	----------	----------	-----------	----------	-----------	------------

MONTAGE DES PIÈCES PLASTIQUES

MONTAGE DER KUNSTSTOFFTEILE

INSTALLING THE PLASTIC PARTS



Détail embout de faîtière (pièce 2010)
 Abdeckung der Firstspitze (Einzelteil 2010)
 Roof ridge end cover (part 2010)

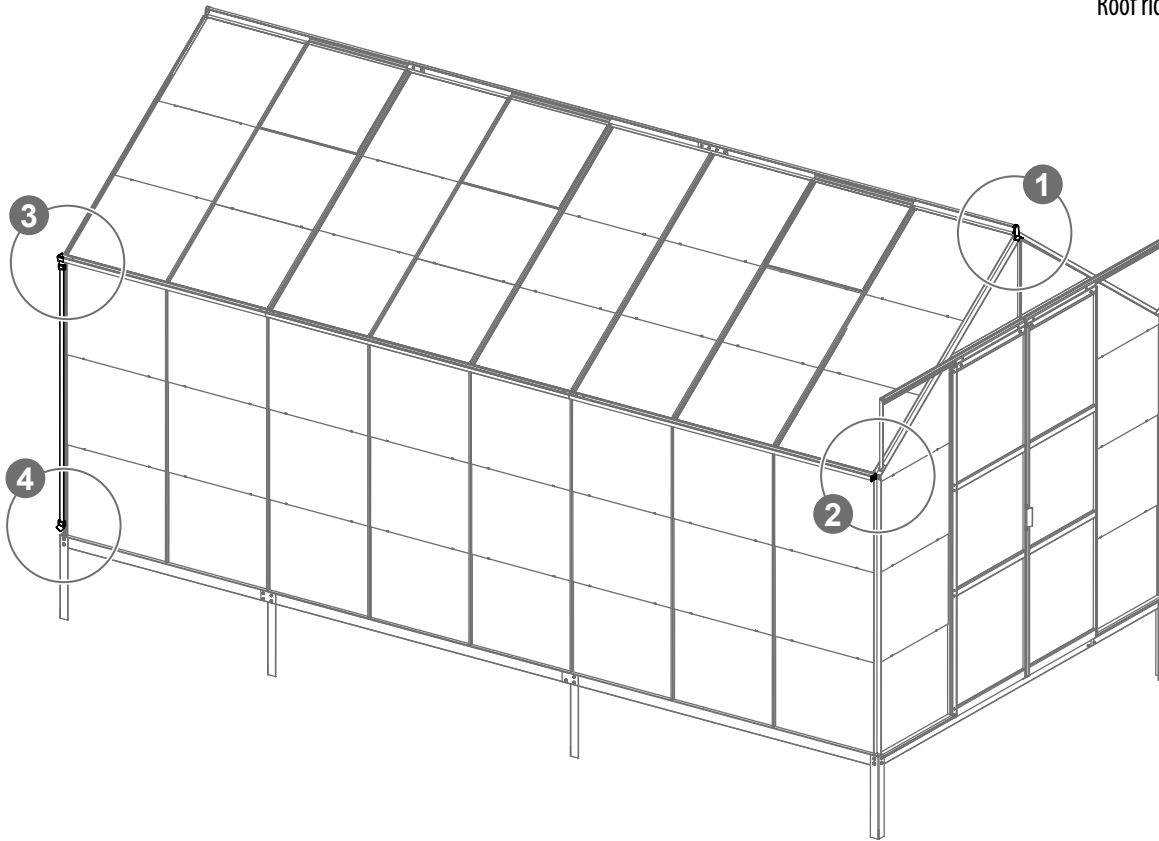

Module de base Basismodul Basic module

	1005 x 4
	2010 x 2
	2022 x 2
	2023 x 2
	2028 x 2
	2032 x 2
	2034 x 2
	58001 x 4

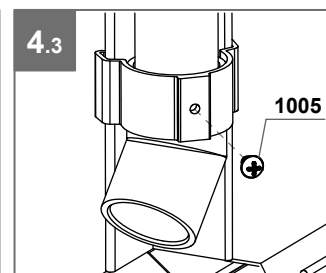
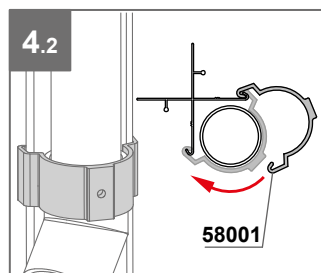
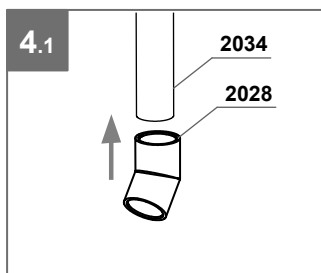
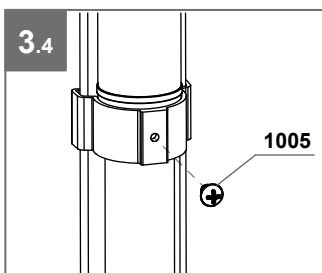
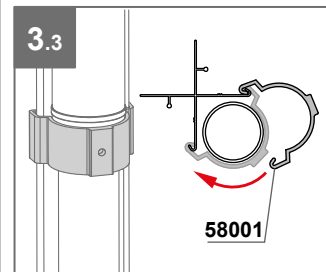
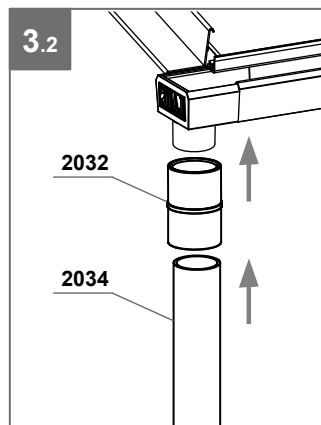
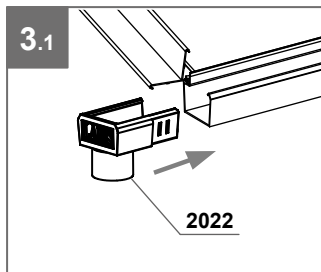
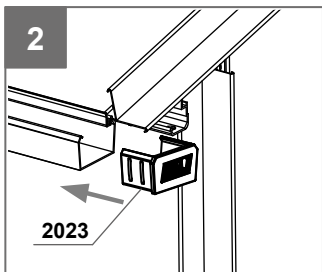
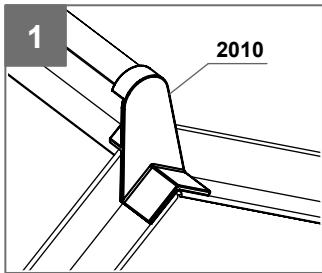

ACCESSOIRES COMPLÉMENTAIRES DISPONIBLES SUR NOTRE SITE ZUSÄTZLICHES ZUBEHÖR AUF UNSERER WEBSITE VERFÜGBAR ADDITIONAL ACCESSORIES AVAILABLE ON OUR WEBSITE

 WWW.SERRES-LAMS.COM

 WWW.GEWAECHSHAUS-LAMS.COM

QUELQUES ACCESSOIRES - EINIGE ACCESSOIRES - SOME ACCESSORIES



Système d'ombrage
Beschattungssystem
Shading system

*Permet de réguler la température de votre serre.
Ermöglicht die Temperatur zu regulieren.
Allows to regulate the temperature of your greenhouse.*



Kit descente de gouttière
Regenfallrohr-Set
Rain gutter kit

*Permet de récupérer l'eau de pluie.
Ermöglicht das Auffangen von Regenwasser.
Allows to collect rainwater.*



Ouverture automatique de lucarne
Automatischer Fensteröffner
Automatic window opener

*Système d'aération automatique (à partir de 17°C).
Automatisches Belüftungssystem (ab 17°C).
Automatic aeration system (from 17°C).*



Ventouse
Saugnapf
Suction cup

*Facilite le transport et la pose des verres.
Erleichtert das Tragen und Anbringen der Gläser.
Facilitates the transport and installation of the glass.*



Clips de vitrage à ressort
Federbelastete Gewächshausklammern
Spring glazing clips

*Permettent de maintenir le vitrage des serres.
Halten die Verglasung der Gewächshäuser.
Maintain the glazing of the greenhouses.*



Crochets de vitrage
Verglasungshaken
Glazing hooks

*Permettent de faire chevaucher deux vitrages.
Ermöglicht die Überlappung von zwei Glasscheiben.
Allows the overlap of two glasses.*

NOTES - NOTIZEN - NOTES

A series of 25 horizontal dotted lines for writing notes.

NOTES - NOTIZEN - NOTES

A series of horizontal dotted lines for writing notes, spanning the width of the page.



 WWW.SERRES-LAMS.COM

SERVICE CLIENTS

Site internet : www.sav-doviris.com

 WWW.GEWAECHSHAUS-LAMS.COM

KUNDENSERVICE

kontakt@gewaechshaus-lams.com