

# kordo.

une marque du groupe  
**BURGER**

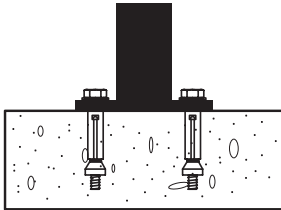

Ø10 x 100  
inox A4



**FIXATION SOL BÉTON**  
*concrete floor fastening*  
REF. 2389

**INOX A4**  
RAL9006

# kordo.

une marque du groupe  
**BURGER**

A x 2  
rèf. 1254

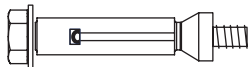

B x 2  
rèf. 72778

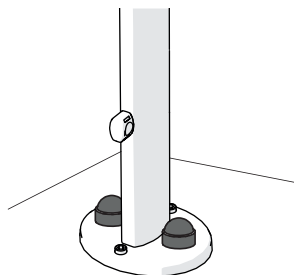
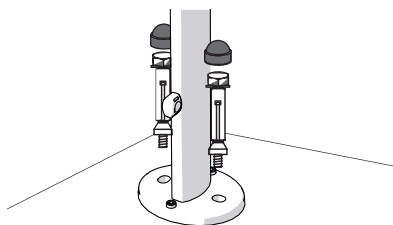
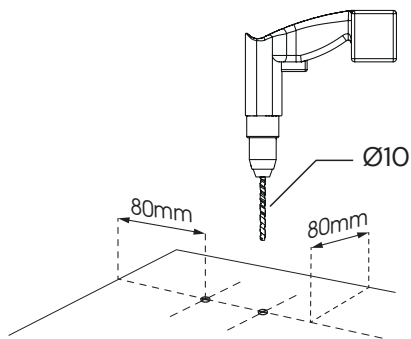
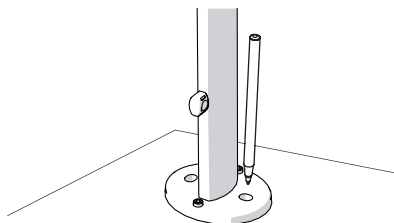

REF. 2389

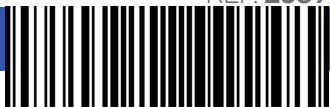

3443440023890



[www.kordodesign.com](http://www.kordodesign.com)



FR  
Éléments  
d'emballage

