

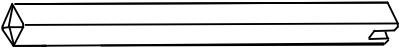

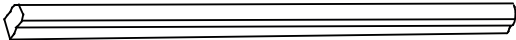

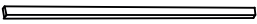

1	20280		1050x70x70 mm	x1
2	20284		3323x55x45 mm	x1
3	20282		812x45x28 mm	x12
4	20281		945x70x70 mm	x1
5	20285		3297x55x25 mm	x1
A	70801		10 gr	x1
B	72042		Ø1.8x40 mm	x12
C	72021		Ø4.5x45 mm	x12
D	72065		Ø5x60 mm	x9
E	72066		Ø6x100 mm	x2
F	72628		Ø15 mm	x11

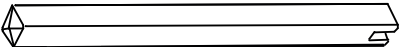
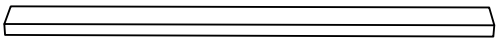

$$B = A - 2C$$

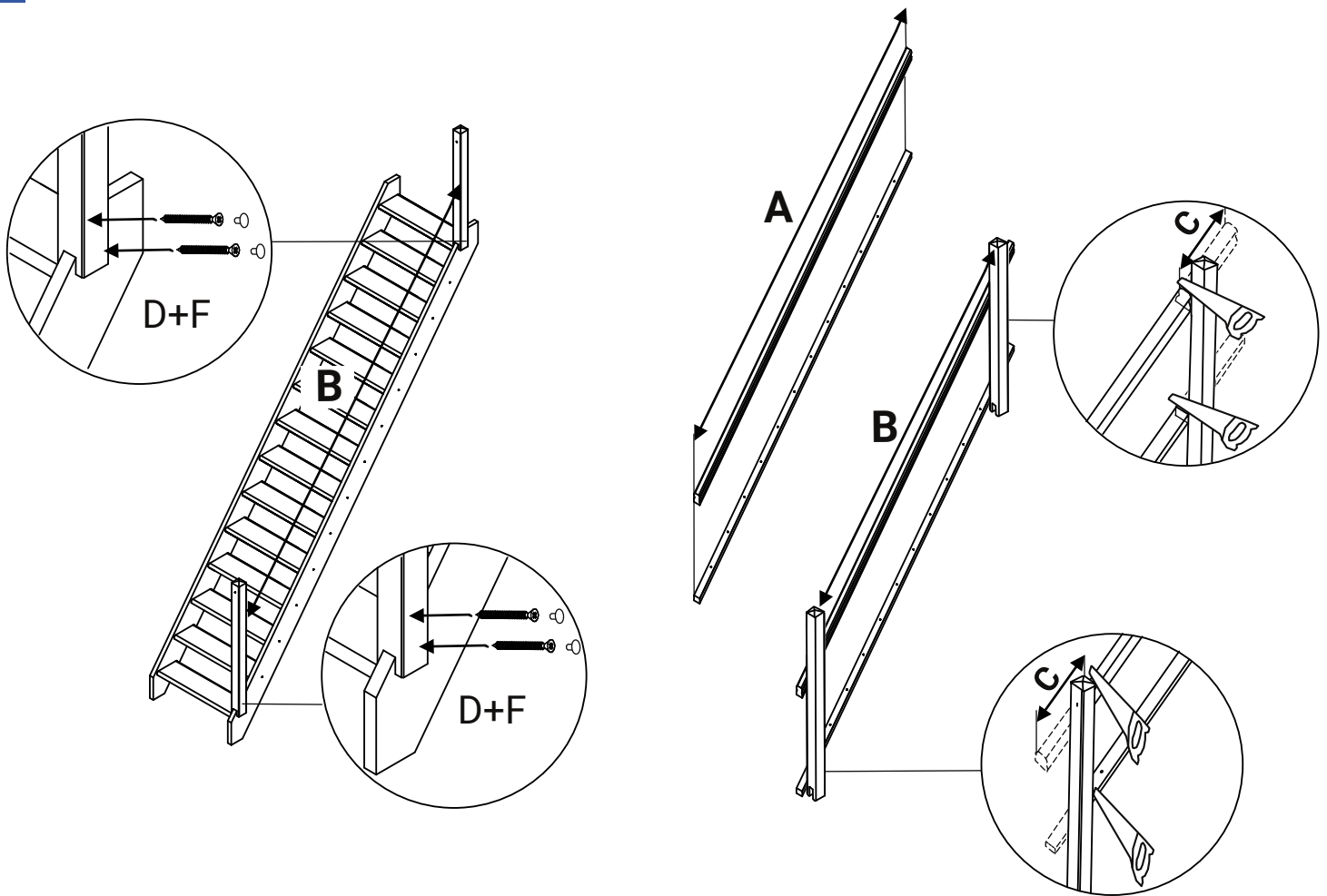