



EAN: 3663602419167

Betty

V10818

EN**Safety**

- For domestic use only.
- Always use on firm level ground.
- Periodic structural checks of this product should be undertaken, do not use if you have any doubts about its fitness for purpose.
- Do not let children play with this product.
- This product must be set up by a competent adult.
- Keep away from naked flames and direct sources of heat such as patio heaters and barbecues.
- Never stay under this product in thunderstorms.
- Do not hang from the ribs, frame and canopy of this product
- This product is designed for occasional use only. This is not to be used as a permanent structure and must be protected from adverse weather conditions such as high winds, heavy rain and snow. Do not use in such conditions. Dismantle and store safely to prevent any damage occurring.

At the beginning of the season

- Check to ensure that all components and fixings of this product are secure, do not use if you have any doubts about its fitness for purpose.

At the end of the season

- This product should be stored under cover during prolonged spells of adverse weather (wet or cold) and also during the winter (ideally in a garden shed or garage).
- Always clean and dry thoroughly before storage.

Manufacturer:

Kingfisher International Products Limited,
3 Sheldon Square, London, W2 6PX,
United Kingdom

Distributor:

B&Q plc, Chandlers Ford, Hants, SO53 3LE
United Kingdom www.diy.com
SFD Limited, Trade House, Mead Avenue,
Yeovil, BA22 8RT, United Kingdom
www.screwfix.com

IMPORTANT, RETAIN FOR FUTURE REFERENCE: READ CAREFULLY.

FR**Sécurité**

- Produit à usage domestique.
- Positionnez le produit de manière stable sur une surface plane.
- Vérifiez régulièrement ce produit. En cas de doute, ne l'utilisez pas.
- Ne laissez pas les enfants manipuler ce produit.
- Ce produit doit être monté par un adulte.
- Tenez le produit à l'écart des flammes et des sources directes de chaleur telles que les radiateurs d'extérieurs et les barbecues.
- Ne pas rester sous ce produit en cas d'orage.
- Ne les laissez pas se suspendre à la structure.
- Ce produit s'utilise occasionnellement. Il ne doit pas être utilisé comme structure permanente ni lors de mauvaises conditions météorologiques telles que les vents violents, les fortes pluies et la neige. Dans de telles conditions, protégez-le ou démontez-le et rangez-le en sécurité pour éviter tout dommage éventuel.
- A monter soi-même.

En début de saison

- Vérifiez que tous les composants et fixations de ce produit soient fermement serrés. En cas de doute, ne l'utilisez pas.

En fin de saison

- L'hiver ou en cas d'intempéries prolongées, il est recommandé de ranger ce produit dans un garage ou une pièce aérée sans chauffage. Ne le couvrez pas.
- Nettoyez et séchez toujours le produit avant de le ranger.

Fabricant:

Kingfisher International Products Limited,
3 Sheldon Square, London, W2 6PX,
United Kingdom

Distributeur:

Castorama France C.S. 50101 Templemars
59637 Wattignies CEDEX www.castorama.fr
BRICO DÉPÔT 30-32 rue de la Tourelle
91310 Longpont-sur-Orge France
www.bricodepot.com

IMPORTANT – A CONSERVER POUR DE FUTURS BESOINS DE REFERENCE : A LIRE SOIGNEUSEMENT

PL**Bezpieczeństwo**

- Meble przeznaczone do użytku prywatnego.
- Zawsze umieszczaj produkt na stabilnej, równej powierzchni.
- Należy okresowo sprawdzać stan produktu. Nie używaj go, jeśli masz jakiegokolwiek wątpliwości.
- Nie pozwól, aby produktem bawiły się dzieci.
- Niniejszy mebel musi zostać zmontowany przez kompetentną osobę dorosłą.
- Trzymaj produkt z dala od płomieni i bezpośrednich źródeł ciepła, takich jak ogrzewacze gazowych i grillów.
- Nigdy nie stój pod niniejszym meblem podczas burzy.
- Nie wieszaj się na poszyciu, jego konstrukcji oraz na ramie tego produktu.
- Niniejszy produkt jest wyłącznie przeznaczony do sezonowego użycia. Nie powinien być używany jako permanentna konstrukcja i musi być chroniony przed niesprzyjającymi warunkami atmosferycznymi, takimi jak silny wiatr lub obfite opady deszczu, śniegu i gradu. Nie używaj w takich warunkach. Rozmontuj i przechowuj w sposób bezpieczny, aby uniknąć uszkodzenia produktu.

Na początku sezonu

- Przed użyciem proszę upewnić się, że wszystkie części i elementy montażowe zostały prawidłowo przymocowane. Nie używaj produktu, jeśli masz jakiegokolwiek wątpliwości na temat ich przydatności do użycia.

Na końcu sezonu

- Niniejszy produkt powinien być przykryty pokrowcem podczas jego przechowywania, jeśli nie zamierzone jest jego użycie przez dłuższy okres czasu lub podczas złych warunków atmosferycznych (opady deszczu lub niska temperatura otoczenia) oraz podczas zimy (najlepiej przechowywać w schowku lub w garażu).
- Zawsze wyczyść i osusz produkty przed przechowywaniem.

Producent:

Kingfisher International Products Limited,
3 Sheldon Square, London, W2 6PX,
United Kingdom

Dystrybutor:

Castorama Polska Sp. z o.o.
ul. Krakowiaków 78
02-255 Warszawa
www.castorama.pl

WAŻNE – NALEŻY DOKŁADNIE PRZECZYTAĆ NINIEJSZE INFORMACJE I ZACHOWAĆ.

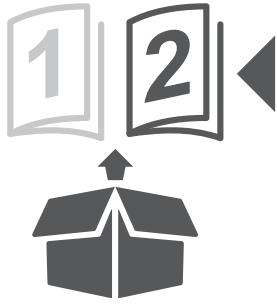

blooma 



EAN: 3663602419167

Betty

V10818



EN IMPORTANT - Please read carefully the separate safety guide before use.

FR IMPORTANT - Lire attentivement le guide de sécurité séparé avant utilisation.

PL WAŻNE - Przed użyciem proszę dokładnie zapoznać się z instrukcją bezpieczeństwa.

RUS ВАЖНО - Пожалуйста, внимательно прочитайте отдельное руководство по технике безопасности перед использованием.

RO IMPORTANT - Vă rugăm să citiți cu atenție ghidul de siguranță separat înainte de utilizare.

ES IMPORTANTE - Lea atentamente la guía de seguridad separado antes de utilizar.

PT IMPORTANTE - Leia atentamente o guia de segurança separado antes de usar.

TR ÖNEMLI - Kullanmadan önce emniyet kurallarını lütfen dikkatle okuyun.

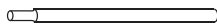
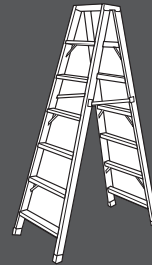
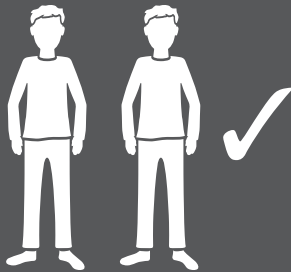

[01] x 8
(Ø34 X 802 mm)

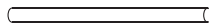

[02] x 8
(Ø34 X 802 mm)

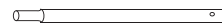

[03] x 9
(Ø34 X 990 mm)

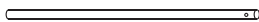

[04] x 9
(Ø34 X 990 mm)

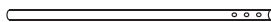

[05] x 8
(Ø34 X 990 mm)

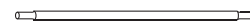

[06] x 8
(Ø34 X 990 mm)



[07] x 6



[08] x 6



[09] x 24

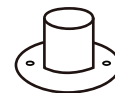

[10] x 8



[11] x 8
(3000 mm)



[12] x 1

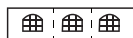

[13] x 2



[14] x 2



[15] x 56



EN Assembly
 RUS Сборка
 PT Montagem

FR Assemblage
 RO Asamblare
 TR Kurulum

PL Montaż
 ES Montaje

01

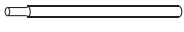

[01] x 8

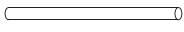

[02] x 8

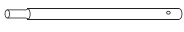

[03] x 9

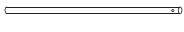

[04] x 9



[08] x 6

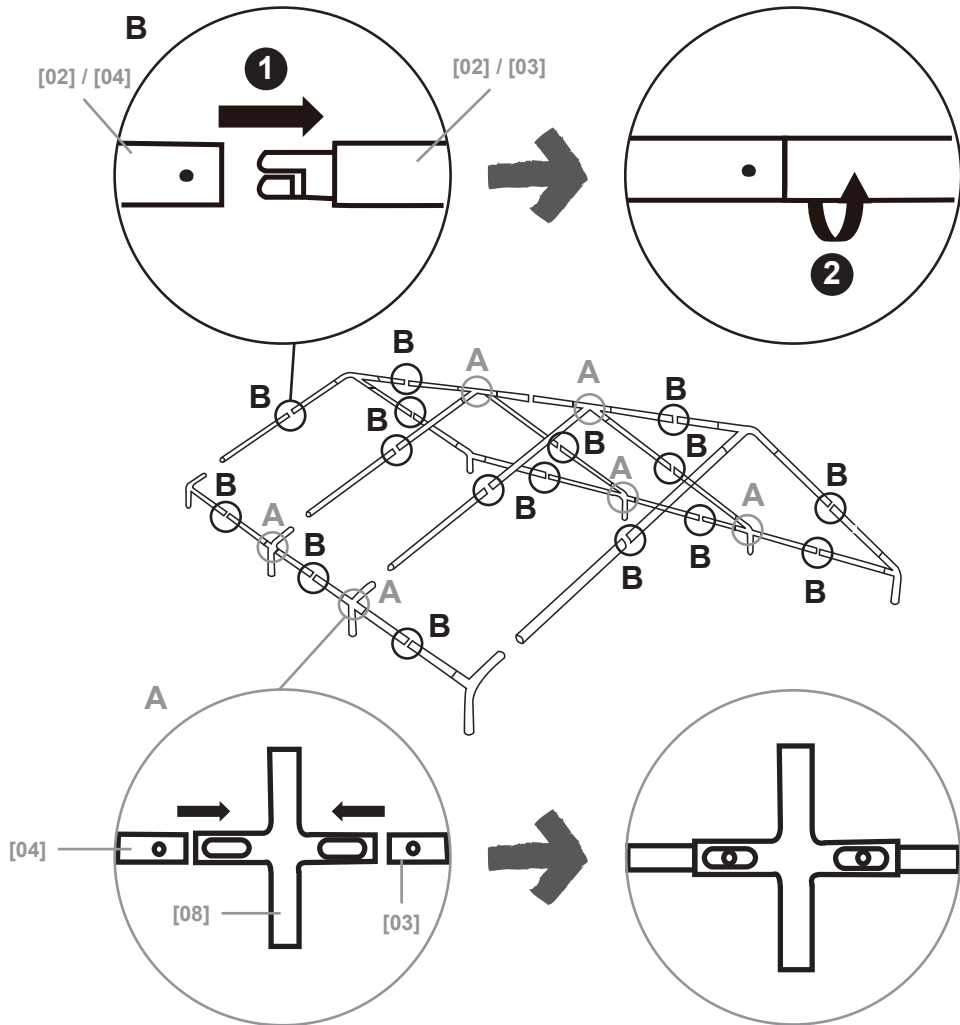
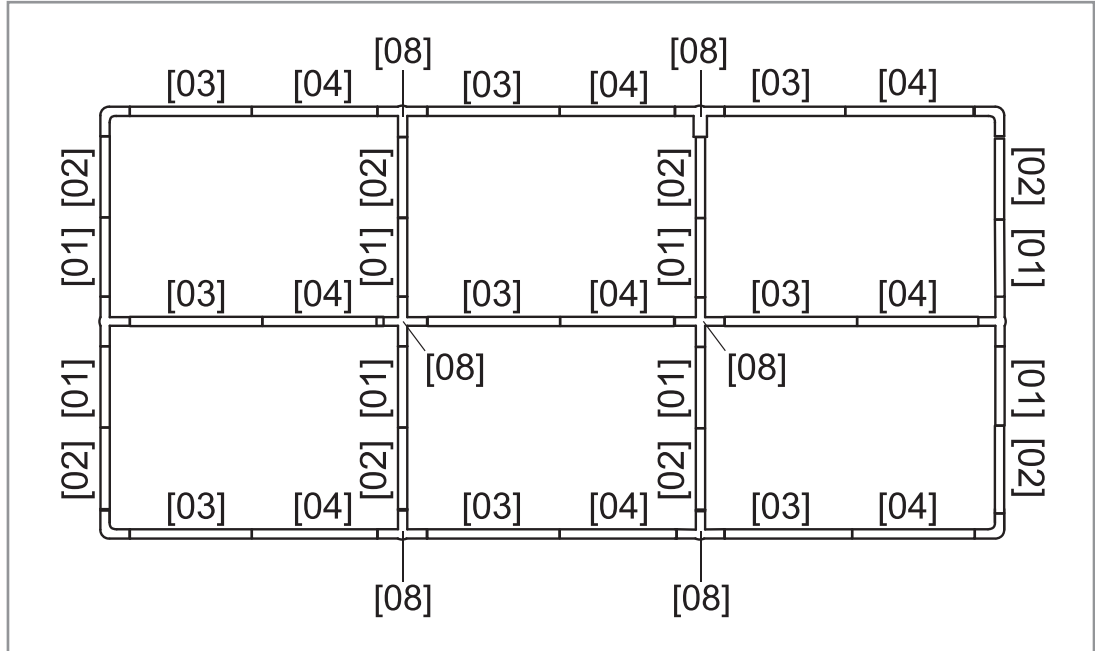



EN Assembly
 RUS Сборка
 PT Montagem

FR Assemblage
 RO Asamblare
 TR Kurulum

PL Montaż
 ES Montaje

02



[07] x 6

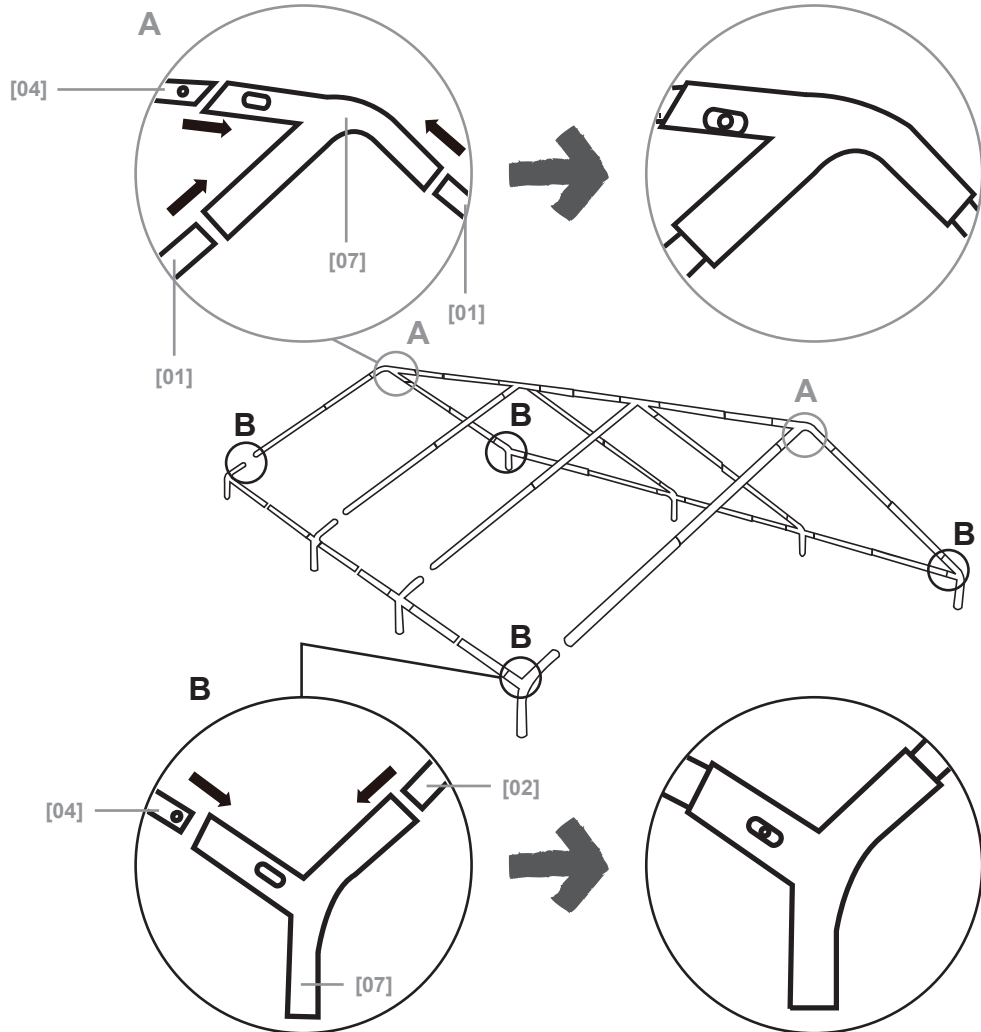
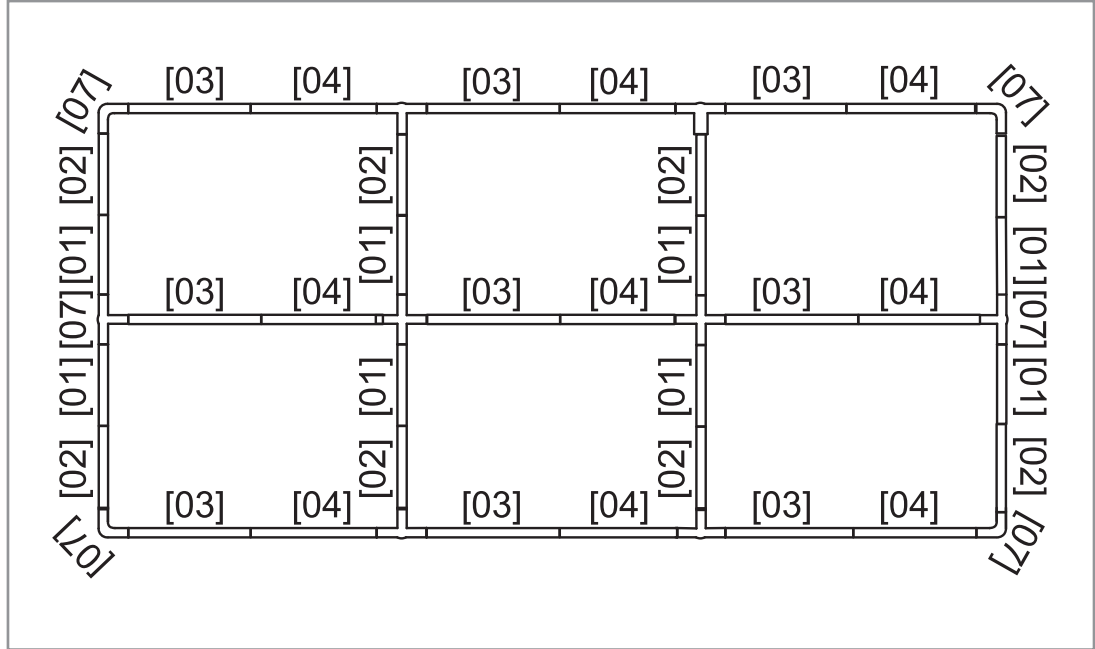

03

[05] x 8

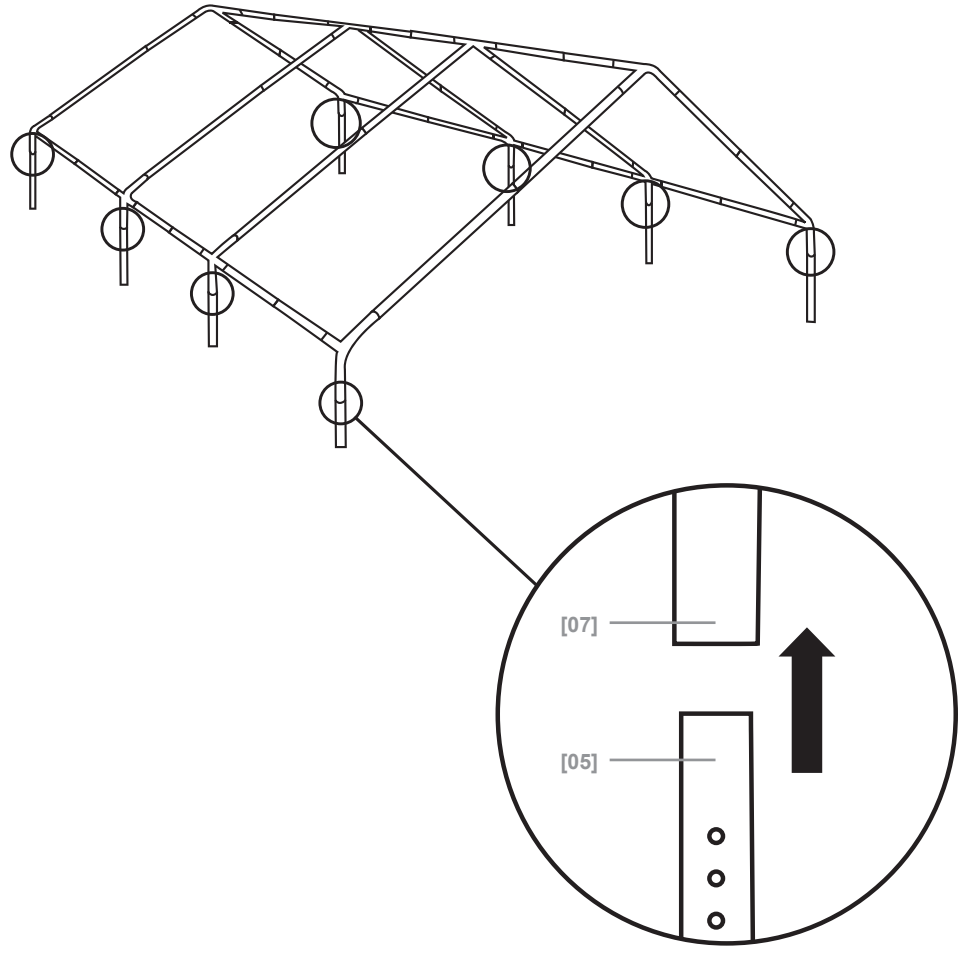

04

[06] x 8

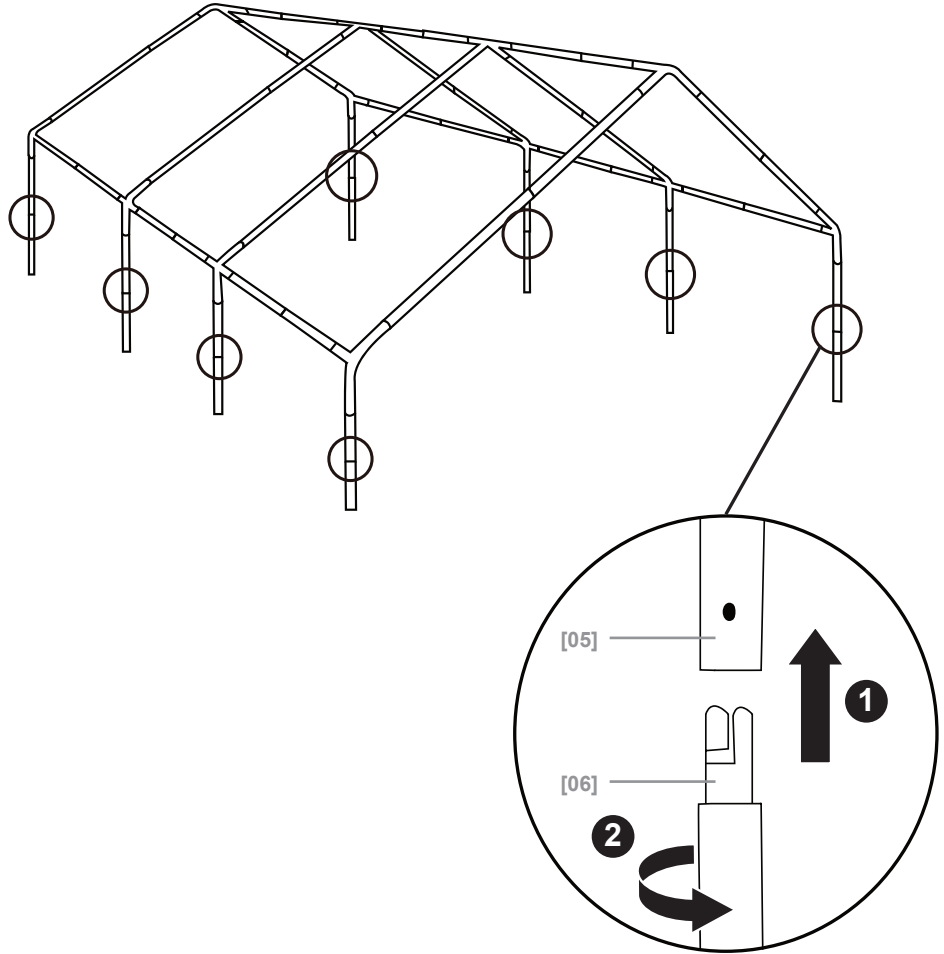

05



[12] x 1

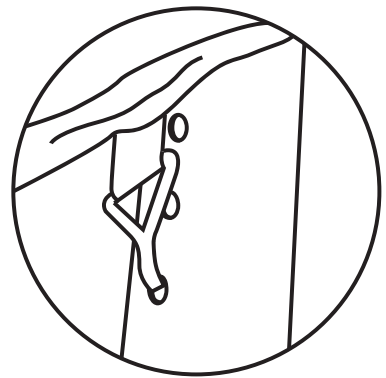
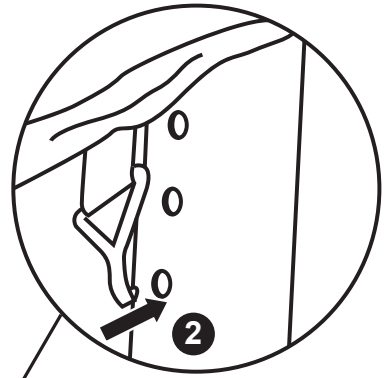
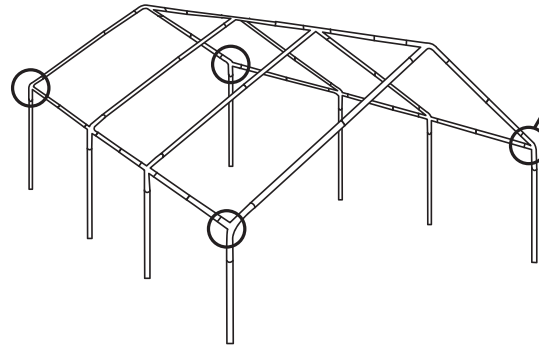
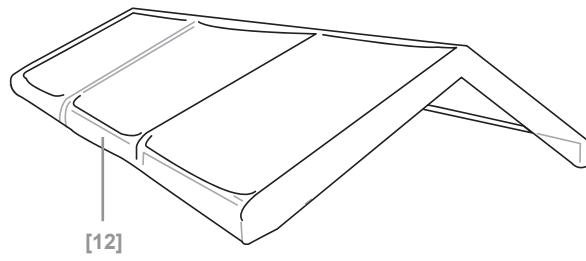

06



[14] x 2



[15] x 16

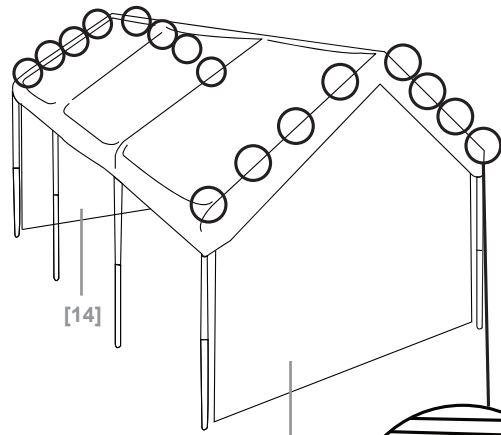

x 16

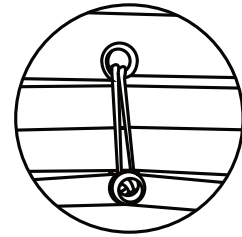
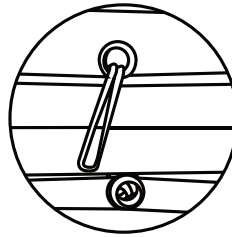
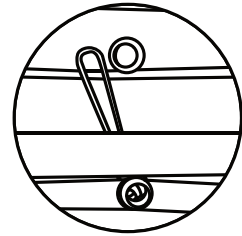
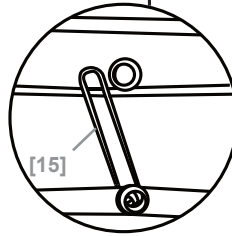

07



[13] x 2



[15] x 24

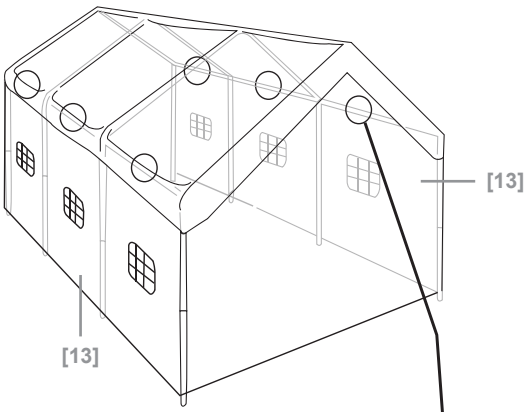

x 16

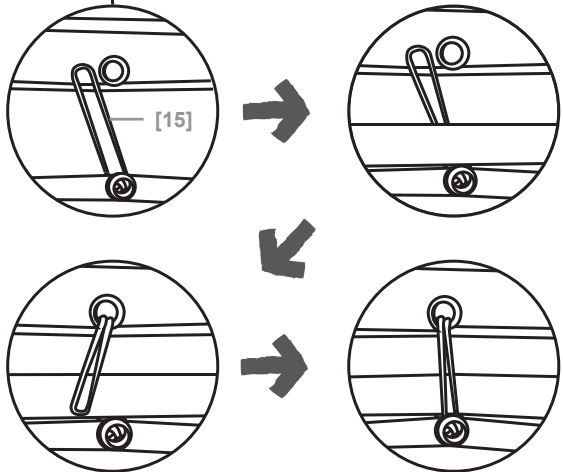

08



[15] x 16

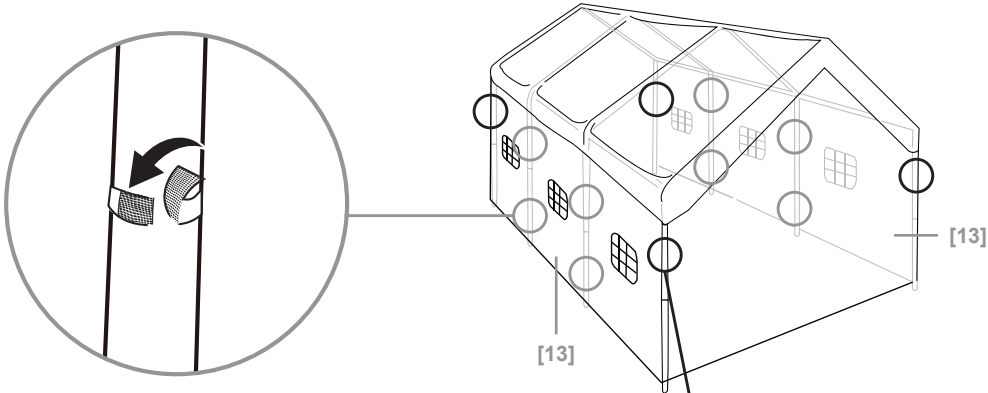

x 16

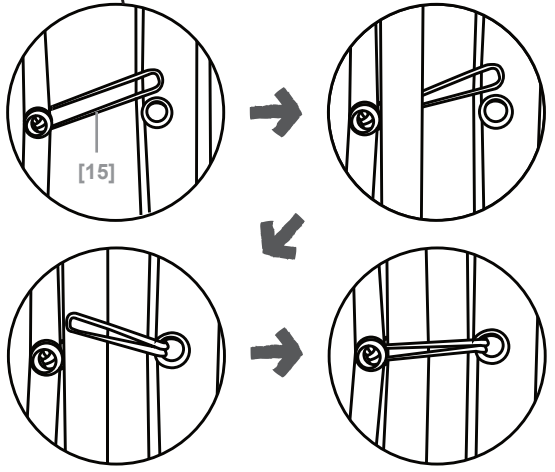

09



[09] x 24



[10] x 8



[11] x 8

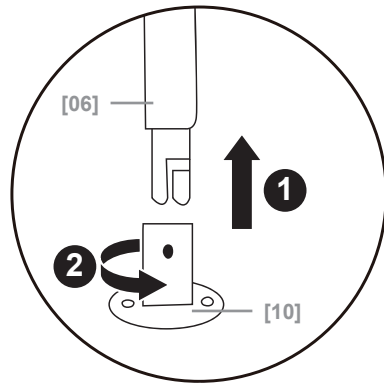

x 8

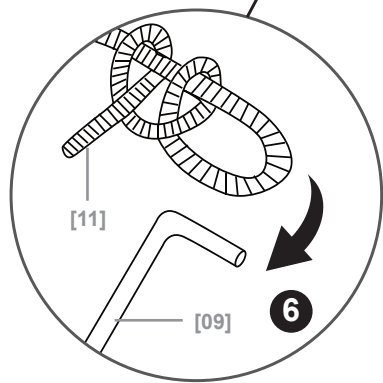
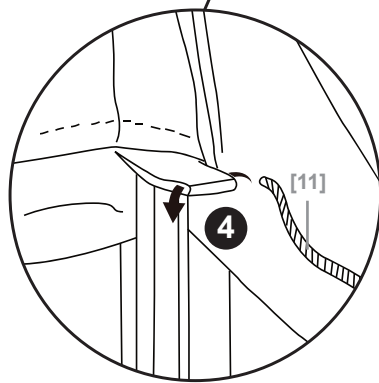
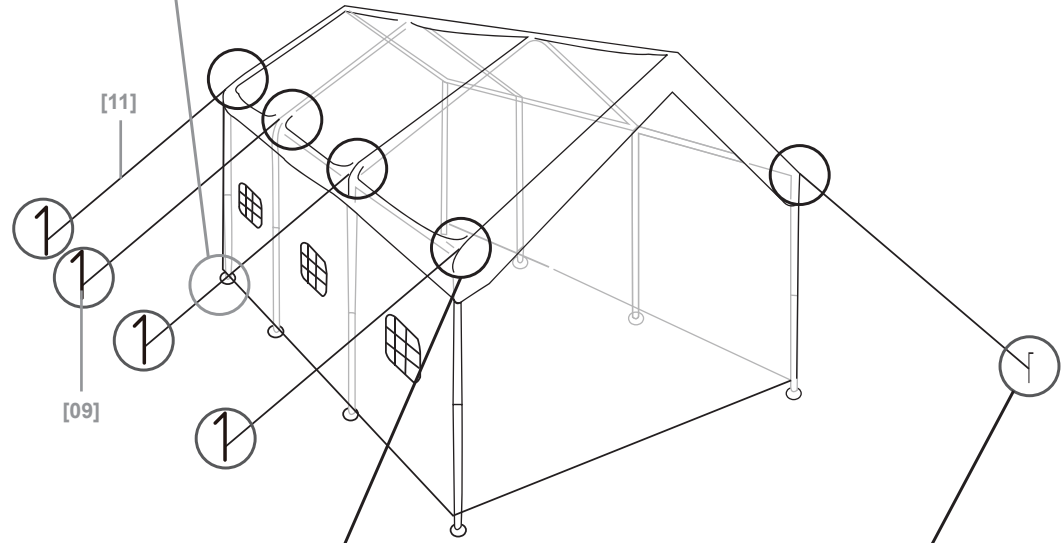
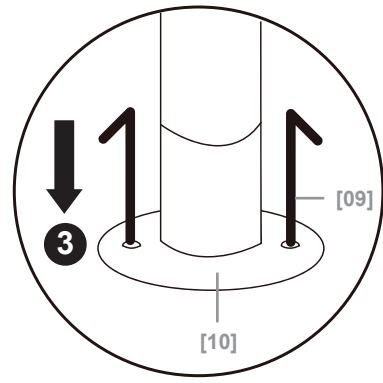

x 8

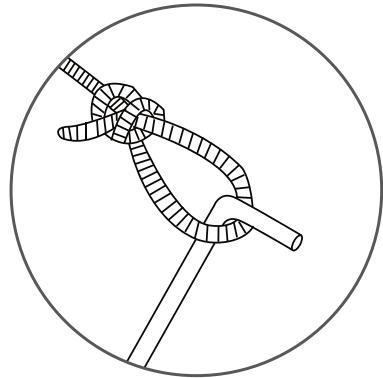
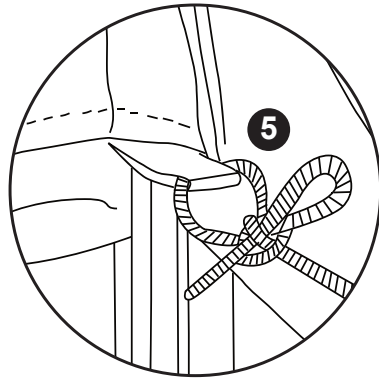

10

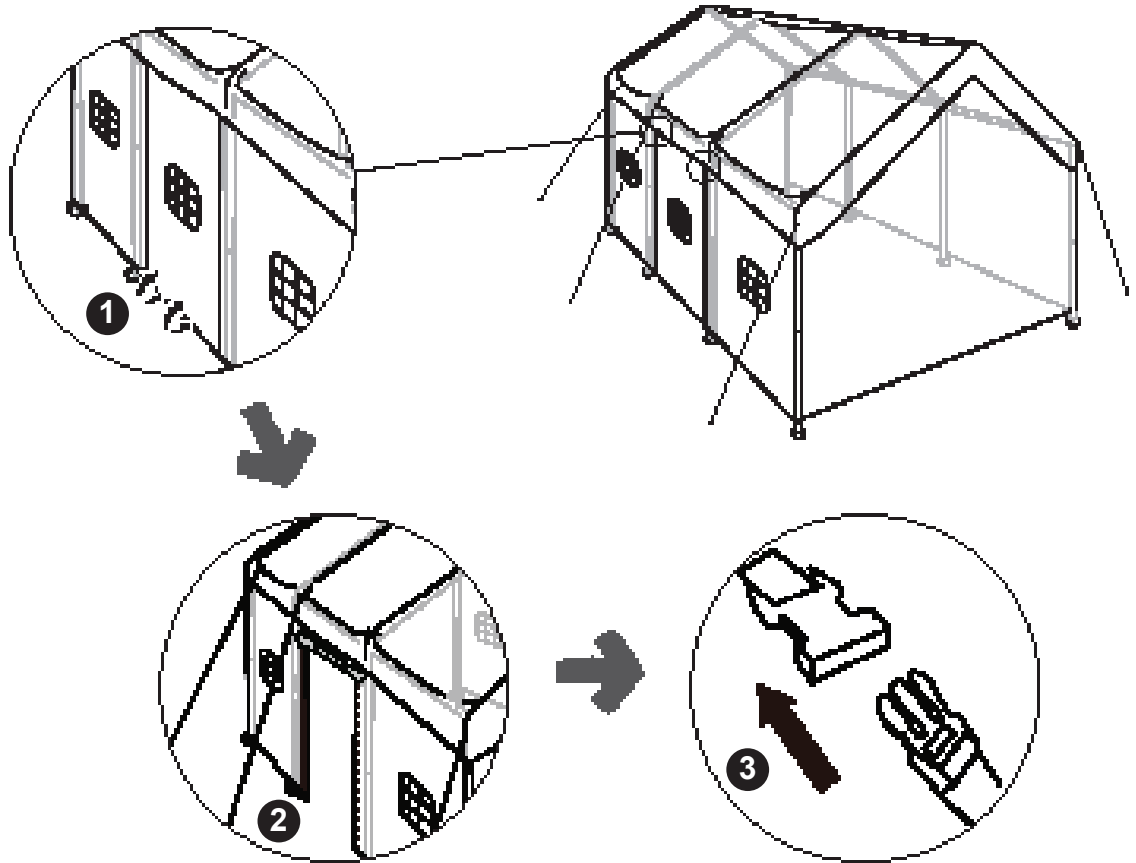

- EN Care
- FR Entretien
- PL Pielęgnacja
- RUS Уход
- RO Îngrijire
- ES Advertancia
- PT Aviso
- TR Bakım

