

UO3-WF31-273

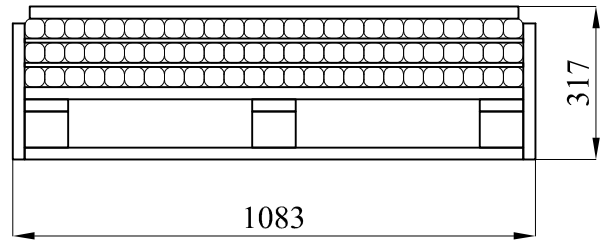
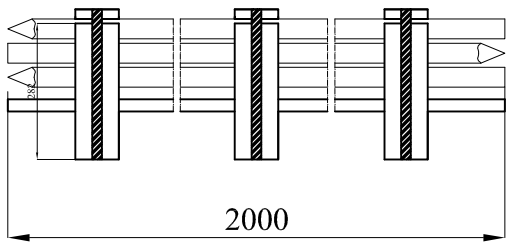
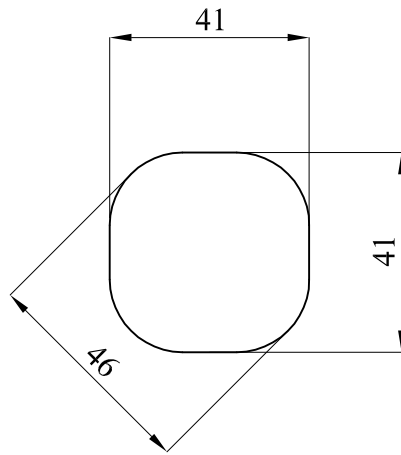
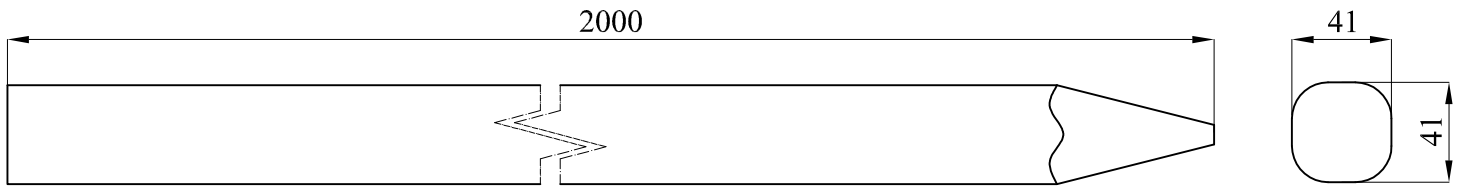

VE - 75
25x3