

3663602776123

# Levanto



=



+



**EN** IMPORTANT - Please read carefully the separate safety guide before use.

**FR** IMPORTANT - Lire attentivement le guide de sécurité séparé avant utilisation.

**PL** WAŻNE - Przed użyciem proszę dokładnie zapoznać się z instrukcją bezpieczeństwa.

**DE** WICHTIG - Bitte lesen sie die separaten sicherheitsanweisungen vor gebrauch.

**RUS** ВАЖНО - Пожалуйста, внимательно прочитайте отдельное руководство по технике безопасности перед использованием.

**RO** IMPORTANT - Vă rugăm să citiți cu atenție ghidul de siguranță separat înainte de utilizare.

**ES** IMPORTANTE - Lea atentamente la guía de seguridad separado antes de utilizar.

**PT** IMPORTANTE - Leia atentamente o guia de segurança separado antes de usar.

**TR** ÖNEMLI - Kullanmadan önce emniyet kurallarını lütfen dikkatle okuyun.

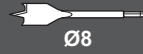
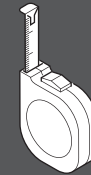
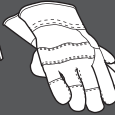
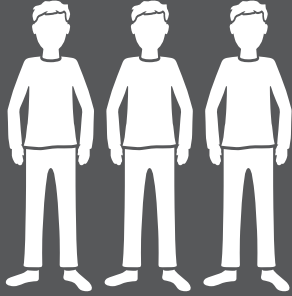

Ø8



Ø8



Ø10

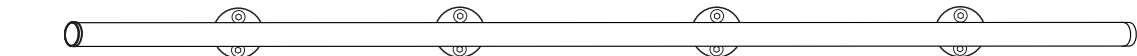

[16] x4



[02] x2

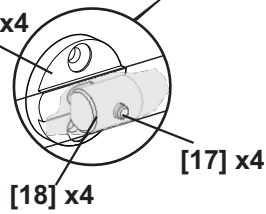

[17] x4

[18] x4

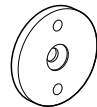

[06] x4



[07] x8  
M6x10



[08] x4  
M6x35



[09] x4  
M6x25

[01] x1



[11] x4  
M6x30



[12] x4  
M6x25

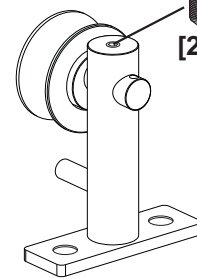

[10] x2

[20] x2



[13] x1  
4mm

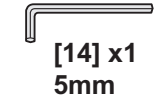

[14] x1  
5mm

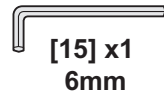

[15] x1  
6mm

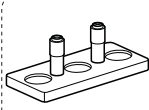

[03] x1



[04] x3  
ST5.5x32

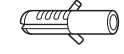

[05] x3  
Ø10

Or  
Ou  
Lub  
или  
Sau  
O  
Veya  
Oder

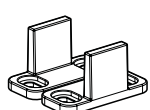

[21] x1

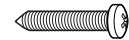

[22] x4  
ST4.2x35

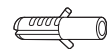

[23] x4  
Ø8

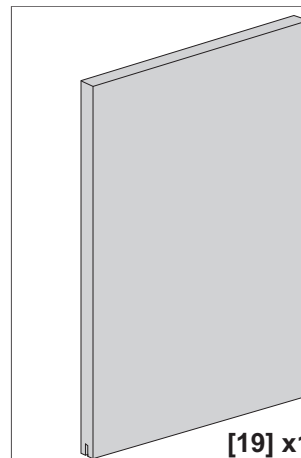

[19] x1

- EN** Excluded
- DE** Ausgeschlossen
- ES** Excluidos
- FR** Exclue
- RUS** исключены
- PT** Excluídos
- PL** Wyłączone
- RO** Exclude
- TR** Dışlanan



EN Installation  
DE Installation  
ES Instalación

FR Installation  
RUS Установка  
PT Instalação

PL Instalacja  
RO Instalare  
TR Montaj

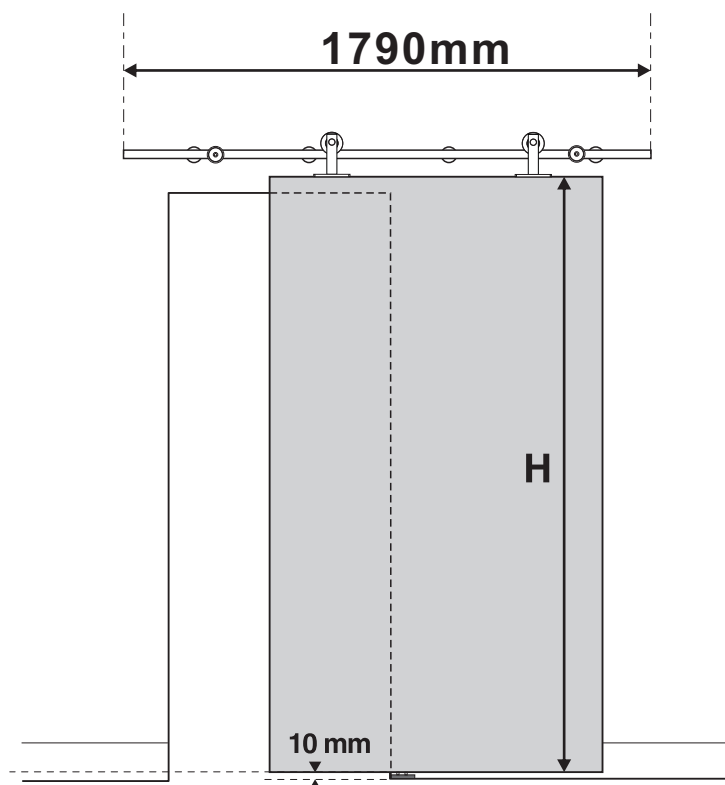

# 01

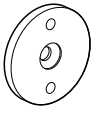

[06] x4



[08] x4

M6x35



[09] x4

M6x25



[13] x1  
4mm

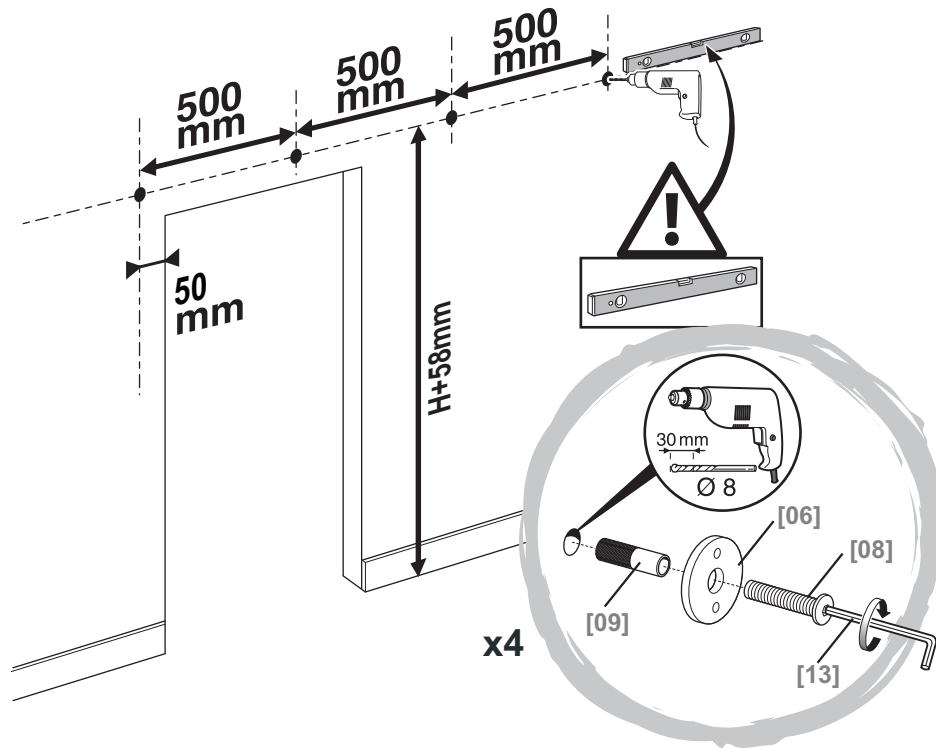

# 02

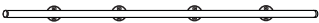

[01] x1



[02] x2



[07] x8

M6x10



[13] x1  
4mm



[14] x1  
5mm

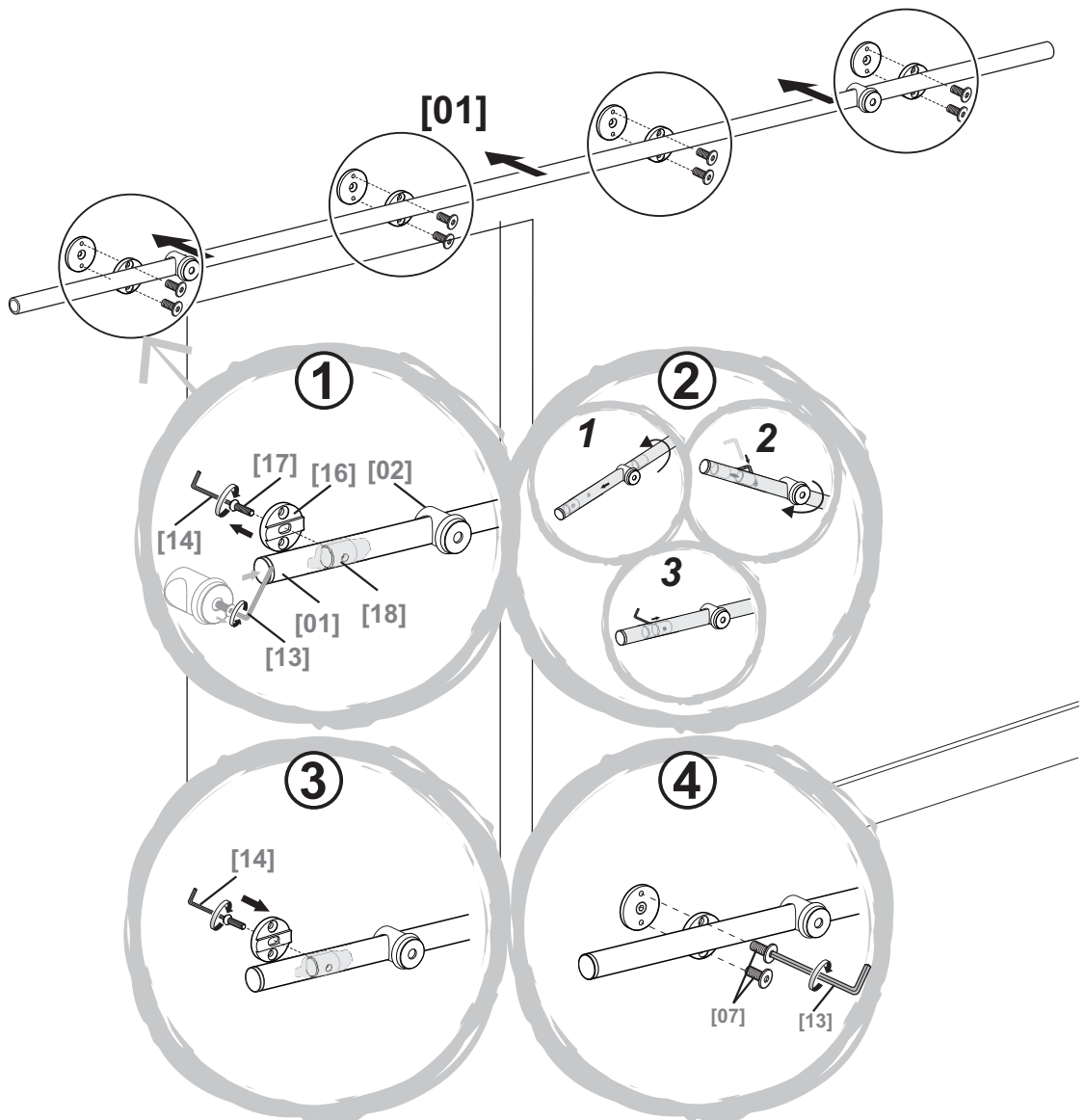



# 05

[13] x1  
4mm

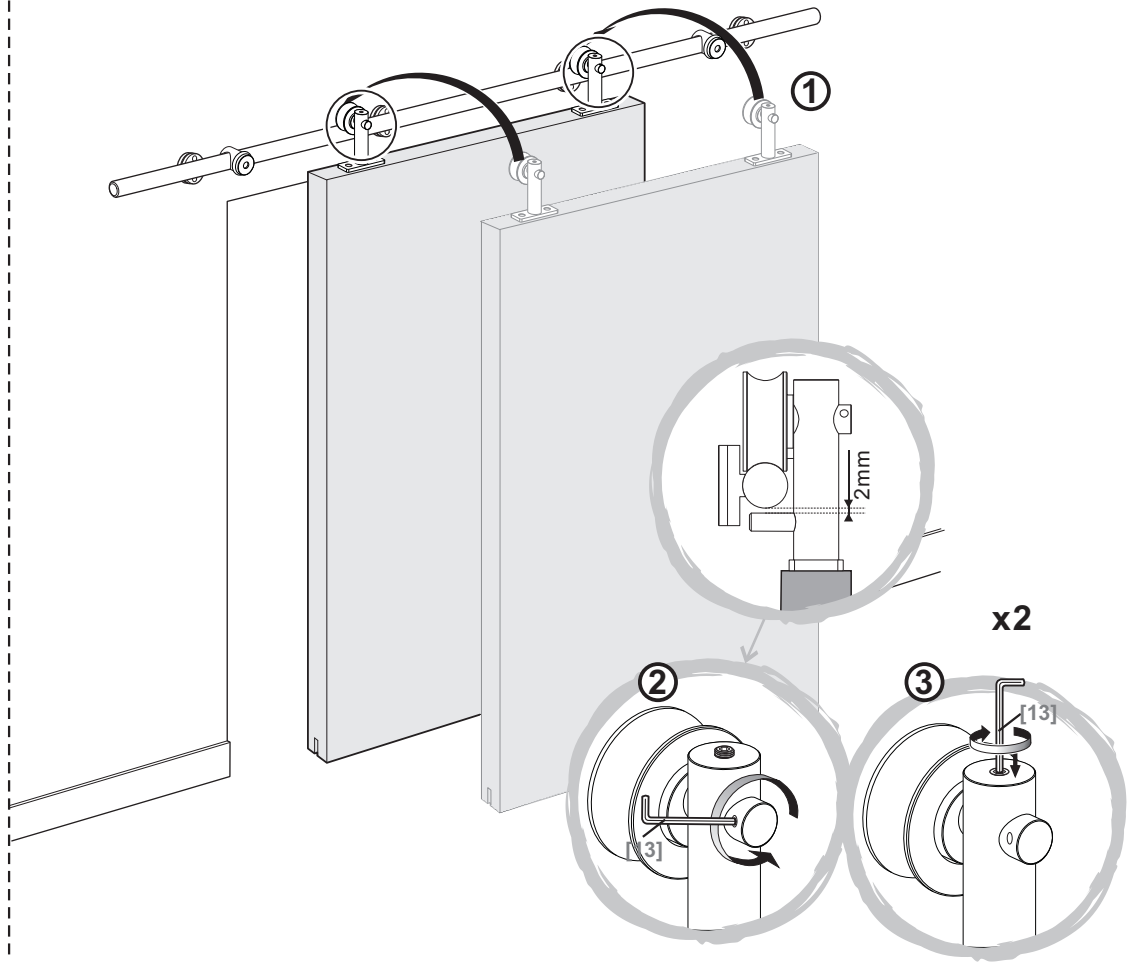

# 06

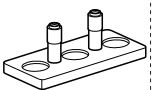

[03] x1



[04] x3  
ST5.5x32



[05] x3  
Ø10

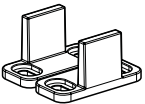

[21] x1



[22] x4  
ST4.2x35



[23] x4  
Ø8

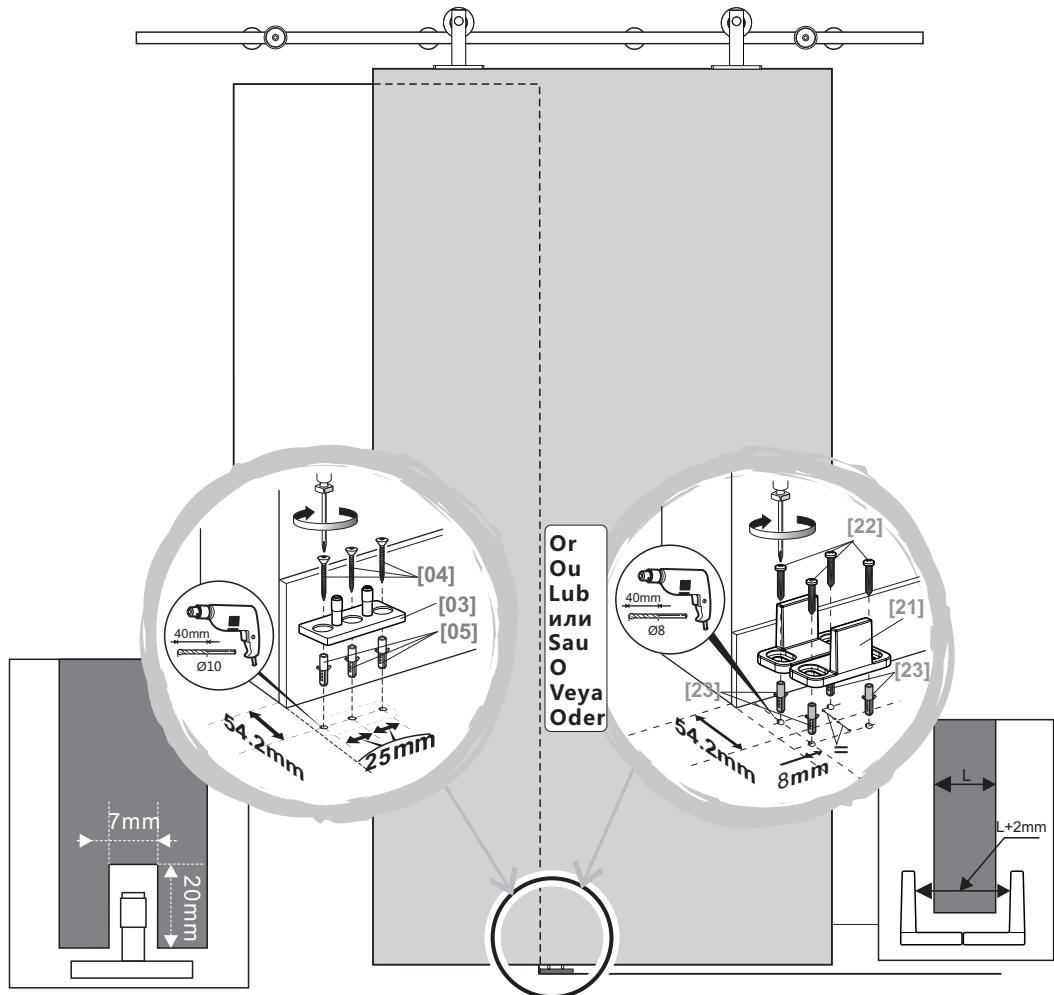

07

[13] x1  
4mm

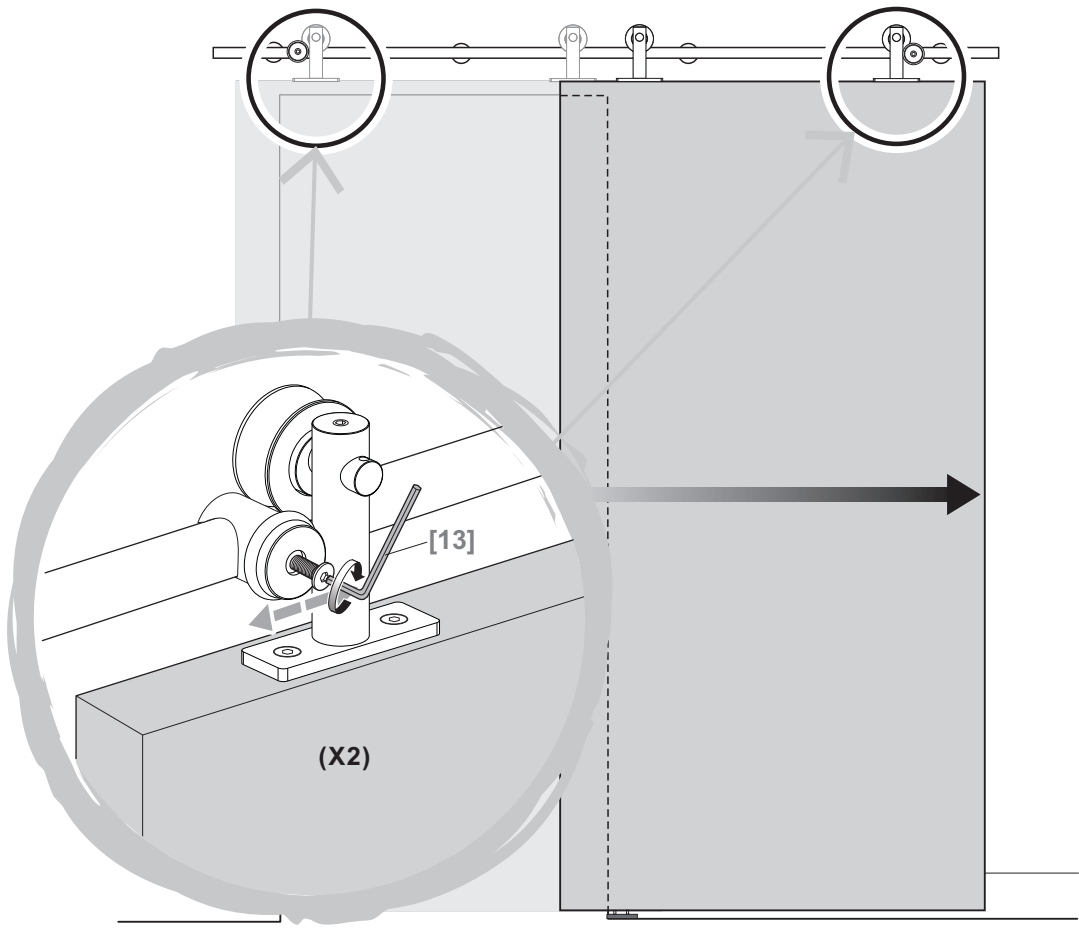

Kingfisher International Products Limited,  
3 Sheldon Square, London, W2 6PX,  
United Kingdom

**EN Distributor:**

B&Q plc, Chandlers Ford, Hants,  
SO53 3LE United Kingdom [www.diy.com](http://www.diy.com)

SFD Limited, Trade House, Mead Avenue,  
Yeovil, BA22 8RT, United Kingdom

**Manufacturer, Fabricant, Hersteller,  
Producator, Fabricante:**

Kingfisher International Products Limited,  
3 Sheldon Square, London, W2 6PX,  
United Kingdom

**FR Distributeur:**

Castorama France C.S. 50101  
Templemars 59637 Wattignies CEDEX  
[www.castorama.fr](http://www.castorama.fr)

BRICO DÉPÔT 30-32 rue de la Tourelle  
91310 Longpont-sur-Orge France  
[www.bricodepot.com](http://www.bricodepot.com)

**PL Dystrybutor:**

Castorama Polska Sp. z o.o.  
ul. Krakowiaków 78, 02-255 Warszawa  
[www.castorama.pl](http://www.castorama.pl)

**DE** Screwfix Direct Limited Mühlheimer  
Straße 15363075 Offenbach/Main  
[www.screwfix.de](http://www.screwfix.de)

**RUS Импортёр:**

ООО "Касторама РУС" Дербеневская  
наб., дом 7, стр 8 Россия, Москва,  
115114  
[www.castorama.ru](http://www.castorama.ru)

**Изготовитель для России:**

Нингбо Тенгью:

**Адрес:** № 1, строение 5, № 1, строение  
4, № 1, строение 2, № 1, строение 1,  
№ 1, Путошань Ист Роуд, Даки, район  
Бэйлунь, Нинбо, Чжэцзян, Китай, 315819  
Дата изготовления (месяц.год) см.  
на упаковке

**RO Distribuitor:**

SC Bricostore România SA Calea Giuleşti  
1-3, Sector 6, Bucureşti România  
[www.bricodepot.ro](http://www.bricodepot.ro)

**ES Distribuidor:**

Euro Depot España, S.A.U. c/ La Selva,  
10 - Edificio Inblau A 1a Planta 08820-El  
Prat de Llobregat [www.bricodepot.es](http://www.bricodepot.es)

**PT Distribuidor:**

Brico Depot Portugal SA Rua Castilho,  
5 - 1 esquerdo, sala 13 1250-066 Lisboa  
[www.bricodepot.pt](http://www.bricodepot.pt)

**TR İthalatçı Firma:**

KOÇTAŞ YAPI MARKETLERİ TİC. A.Ş.  
Taşdelen Mah. Sırrı Çelik Bulvarı No:5  
34788 Taşdelen/Çekmeköy/İSTANBUL  
Tel: +90 216 4300300  
Faks: +90 216 4844313  
[www.koctas.com.tr](http://www.koctas.com.tr)

Yetkili servis istasyonları ve yedek parça  
temini için aşağıda yer alan Koçtaş Müşteri  
Hattı ve Koçtaş Genel Müdürlük irtibat  
bilgilerinden faydalanınız.

KOÇTAŞ MÜŞTERİ HİZMETLERİ  
0850 209 50 50





3663602776086 / 3663602776123 / 3663602776093 / 3663602776130 /  
3663602776109 / 3663602776147 / 3663602776116

# Lugano / Levanto

V11117

**EN**

## Safety instructions

- ☑ The instructions outlined below are intended to ensure your safety. Please read the safety manual and the instruction manual carefully before undertaking the sliding door system construction or mounting.
- ☑ Ensure that both the safety manual and instruction manual are retained for future reference.
- ☑ The sliding door system must be installed by a minimum of 3 adults who are proficient in the skills required to complete the task as outlined in the instruction manual.
- ☑ The mounting screws supplied are suitable for concrete and brick walls.
- ☑ Ensure safety eyewear is worn when drilling, chiseling and handling concrete.
- ☑ Ensure protective gloves are worn if handling concrete.
- ☑ Do not construct, mount or use this product if it damaged or elements are missing.
- ☑ Do not modify the construction or design of this product. Failure to follow this instruction could lead to injury, death or property damage.
- ☑ Refrain from using this sliding door system for anything other than its intended purpose.
- ☑ Ensure that you have all the tools specified in the instruction manual available before undertaking the sliding door system construction or mounting.
- ☑ This product is intended for indoor use only.
- ☑ This product is intended for domestic use only.
- ☑ Do not over tighten the screws, nuts or bolts provided. Check at least once a year that the screws, nuts or bolts are still safely tightened. Re-tighten them if needed.
- ☑ Handle any tool used carefully and in accordance with their instructions.
- ☑ Do not hang any load off the product.
- ☑ If there is any sign that the sliding system does not work properly or prone to be defective, please stop using this sliding system.
- ☑ Every six month check if all connections of components are in good condition.
- ☑ Every six month check if all fixations on the wall and fixations on the floor are in good condition.
- ☑ Do not slam the door too hard to extend the working life and avoid any accidental injuries.

## Care & maintenance

- ☑ Use a soft damp cloth to clean the surface of the product. Wipe dry with a clean cloth.
- ☑ Never use any solvents, scourers, abrasives, bleach, acids, strong detergents, aggressive chemical cleaners or solvent-type cleaning solutions on the product.

**IMPORTANT, RETAIN FOR FUTURE REFERENCE: READ CAREFULLY.**

### Manufacturer:

Kingfisher International Products Limited,  
3 Sheldon Square, London, W2 6PX,  
United Kingdom

### Distributor:

B&Q plc, Chandlers Ford, Hants, SO53 3LE  
United Kingdom [www.diy.com](http://www.diy.com)  
SFD Limited, Trade House, Mead Avenue,  
Yeovil, BA22 8RT, United Kingdom

**FR**

## Consignes de sécurité

- ☑ Les consignes décrites ci-dessous visent à assurer votre sécurité.
- ☑ Veuillez lire attentivement le manuel de sécurité et le manuel d'instructions avant de commencer la construction ou le montage du système de porte coulissante.
- ☑ Conservez le manuel de sécurité et le manuel d'instructions pour une utilisation ultérieure.
- ☑ Le système de porte coulissante doit être installé par au minimum 3 adultes, expérimentés pour effectuer ce travail, tel que mentionné dans le manuel d'instructions.
- ☑ Les vis et chevilles de fixation fournies sont adaptées aux murs en béton et en brique. Pour des murs constitués d'autres matériaux, utilisez des vis et des chevilles adaptées.
- ☑ Portez des lunettes de sécurité lorsque vous percez, burinez et manipulez du béton.
- ☑ Portez des gants de protection lorsque vous manipulez du béton.
- ☑ Ne construisez pas, ne posez pas et n'utilisez pas ce produit s'il est endommagé ou si des éléments sont manquants.
- ☑ Ne modifiez pas la construction ni la conception de ce produit. Le non-respect de cette consigne peut entraîner des dégâts matériels, des blessures, voire la mort.
- ☑ N'utilisez pas ce système de porte coulissante pour un autre usage que celui pour lequel il est prévu.
- ☑ Assurez-vous de disposer des outils spécifiés dans le manuel d'instructions avant de commencer la construction ou le montage du système de porte coulissante.
- ☑ Ce produit est destiné à un usage intérieur uniquement.
- ☑ Ce produit est destiné à un usage domestique uniquement.
- ☑ Ne serrez pas trop les vis, écrous et boulons fournis. Contrôlez au moins une fois par an que les vis, écrous et boulons sont toujours suffisamment serrés. Re-serrez-les si besoin.
- ☑ Manipulez les outils avec précaution et conformément aux instructions d'utilisation.
- ☑ Ne suspendez aucune charge sur le produit.
- ☑ En cas de signe indiquant que le système de porte coulissante ne fonctionne pas correctement ou est susceptible d'être défectueux, veuillez cesser d'utiliser ce système de porte coulissante.
- ☑ Vérifiez une fois tous les six mois si toutes les connexions entre les composants sont en bon état.
- ☑ Vérifiez une fois tous les six mois si toutes les fixations sur les murs et sur le sol sont en bon état.
- ☑ Afin de prolonger la durée de vie de la porte et d'éviter toute blessure accidentelle, ne fermez pas la porte trop violemment.

## Entretien et maintenance

- ☑ Nettoyez la surface du produit à l'aide d'un chiffon doux et humide. Essuyez à l'aide d'un chiffon propre.
- ☑ N'utilisez jamais de solvant, tampon à récurer, matériau abrasif, eau de Javel, acide, détergent puissant, produit nettoyant chimique agressif ou solution de nettoyage à base de solvant pour nettoyer le produit.

**IMPORTANT – A CONSERVER POUR DE FUTURS BESOINS DE REFERENCE : A LIRE SOIGNEUSEMENT.**

### Fabricant :

Kingfisher International Products Limited,  
3 Sheldon Square, London, W2 6PX,  
United Kingdom

### Distributeur :

Castorama France C.S.  
50101 Templemars  
59637 Wattignies CEDEX  
[www.castorama.fr](http://www.castorama.fr)

BRICO DÉPÔT 30-32 rue de la  
Tourelle  
91310 Longpont-sur-Orge France  
[www.bricodepot.com](http://www.bricodepot.com)