

3663602776147

Levanto

V10817

V1a	NH
V1b	INITIALS
V1c	INITIALS
V2a	INITIALS
V2b	INITIALS
V2c	INITIALS
V3a	AM
V3b	AM
V3c	INITIALS



SEPARATIONS	JOB INFO	
 PROCESS BLACK	PID #: RC008 Agency job #: TENG10898 Product Description: CANOPIES	Brand: Geom Brand Contact: jack.watkins@kinfisher.com Vendor: Ningbo Tengyu Barcode: 3663602883265 No. of new line drawings: xx Page size: A4 / No. of printed pages: 12
	VERSION #	
	1 2 3 R 5 6 7 8 21/07/17 03/08/17 04/08/17 17/08/17 00/00/17 00/00/17 00/00/17 00/00/17 NH TjB DLS DLS INITIALS INITIALS INITIALS INITIALS	
This file is the property of Kingfisher Group Plc. No copying, alteration or amendment is permitted without written authorisation from the Kingfisher Brand Team.		
翠丰集团不会以专色(PMS)作参考，请参照已提供的印刷标准及Lab色彩数值生产以符合印刷品之标准。本文件的版权归翠丰集团所有。未经翠丰品牌团队的书面同意，不得对本文件进行复制、变更或修改。		



EN IMPORTANT - Please read carefully the separate safety guide before use.

FR IMPORTANT - Lire attentivement le guide de sécurité séparé avant utilisation.

PL WAŻNE - Przed użyciem proszę dokładnie zapoznać się z instrukcją bezpieczeństwa.

DE WICHTIG - Bitte lesen sie die separaten sicherheitsanweisungen vor gebrauch.

RUS ВАЖНО - Пожалуйста, внимательно прочитайте отдельное руководство по технике безопасности перед использованием.

RO IMPORTANT - Vă rugăm să citiți cu atenție ghidul de siguranță separat înainte de utilizare.

ES IMPORTANTE - Lea atentamente la guía de seguridad separado antes de utilizar.

PT IMPORTANTE - Leia atentamente o guia de segurança separado antes de usar.

TR ÖNEMLI - Kullanmadan önce emniyet kurallarını lütfen dikkatle okuyun.

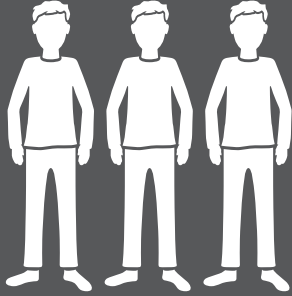

Ø8

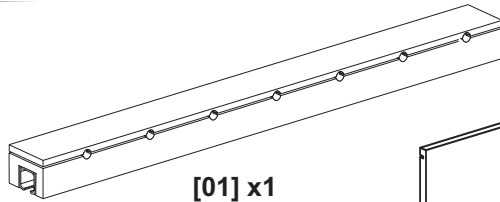
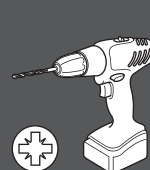
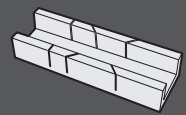

[01] x1

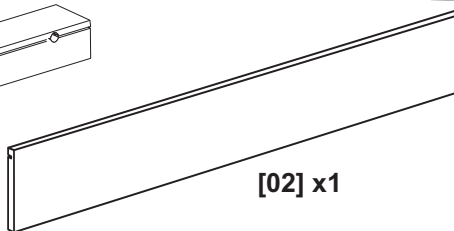

[02] x1



[03] x1

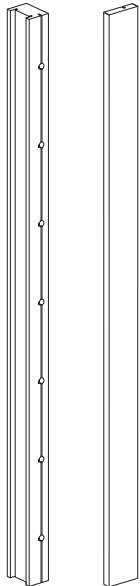

[04] x1 [05] x1



[08] x1

[09] x2



[10] x1



[11] x5



[12] x2



[13] x2

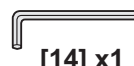

[14] x1

3mm



[06] x14
Ø8

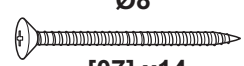

[07] x14
M5x100

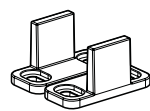

[18] x1



[19] x4
ST4.2x35



[20] x4
Ø8

Or
Ou
Lub
или
Sau
O
Veya
Oder

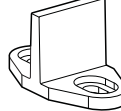

[22] x1



[23] x2
ST4.2x25



[24] x2
Ø8



[15] x2



[16] x2



[17] x8
ST4.8x30



[21] x1

- EN** Excluded
- DE** Ausgeschlossen
- ES** Excluidos
- FR** Exclue
- RUS** исключены
- PT** Excluídos
- PL** Wyłączone
- RO** Excluse
- TR** Dışlanan



EN Installation
DE Installation
ES Instalación

FR Installation
RUS Установка
PT Instalação

PL Instalacja
RO Instalare
TR Montaj

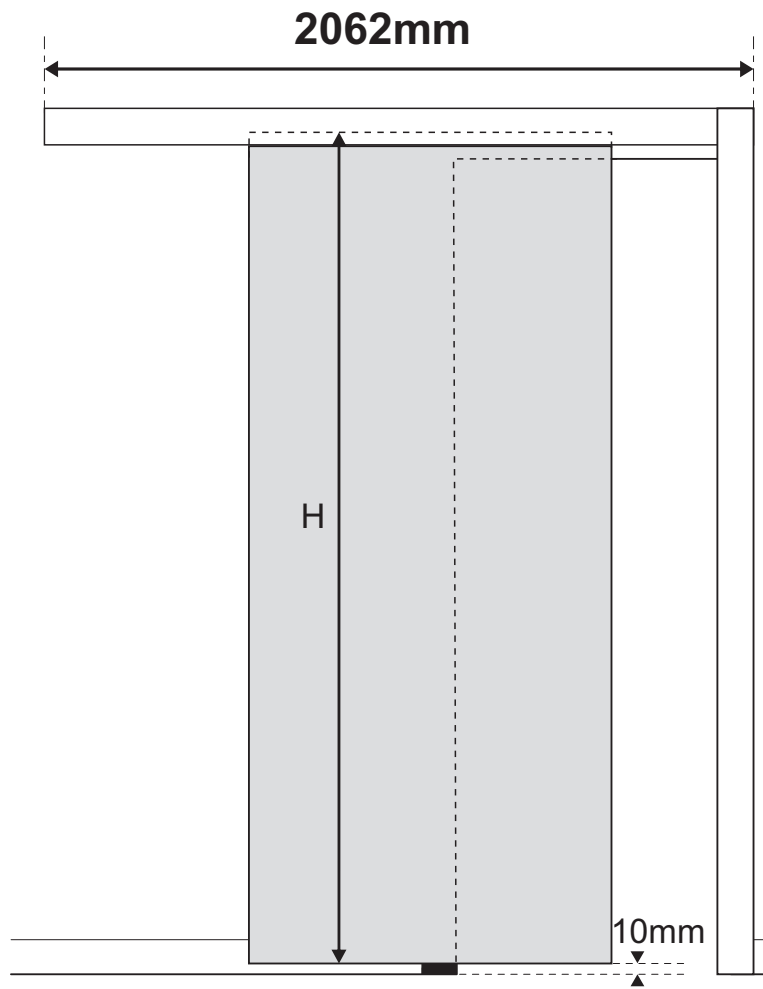

01

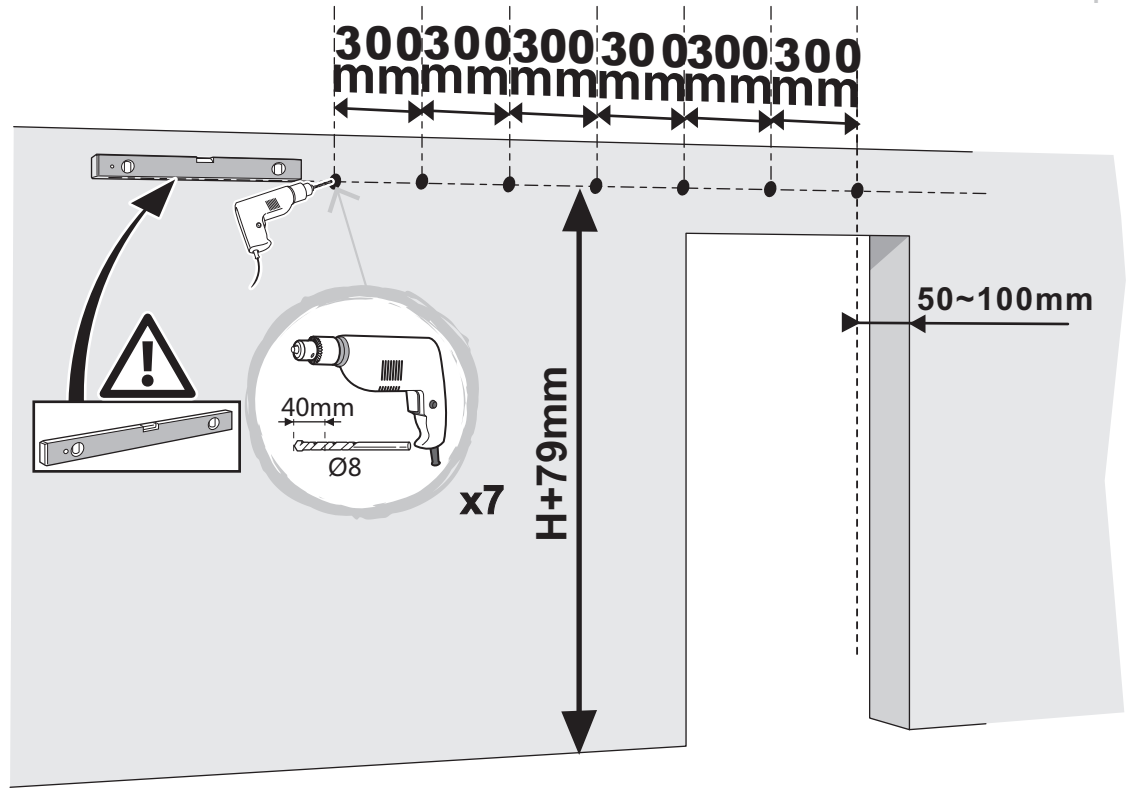

02

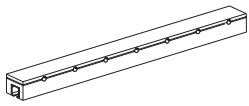

[01] x1



[06] x7
Ø8



[07] x7
M5x100

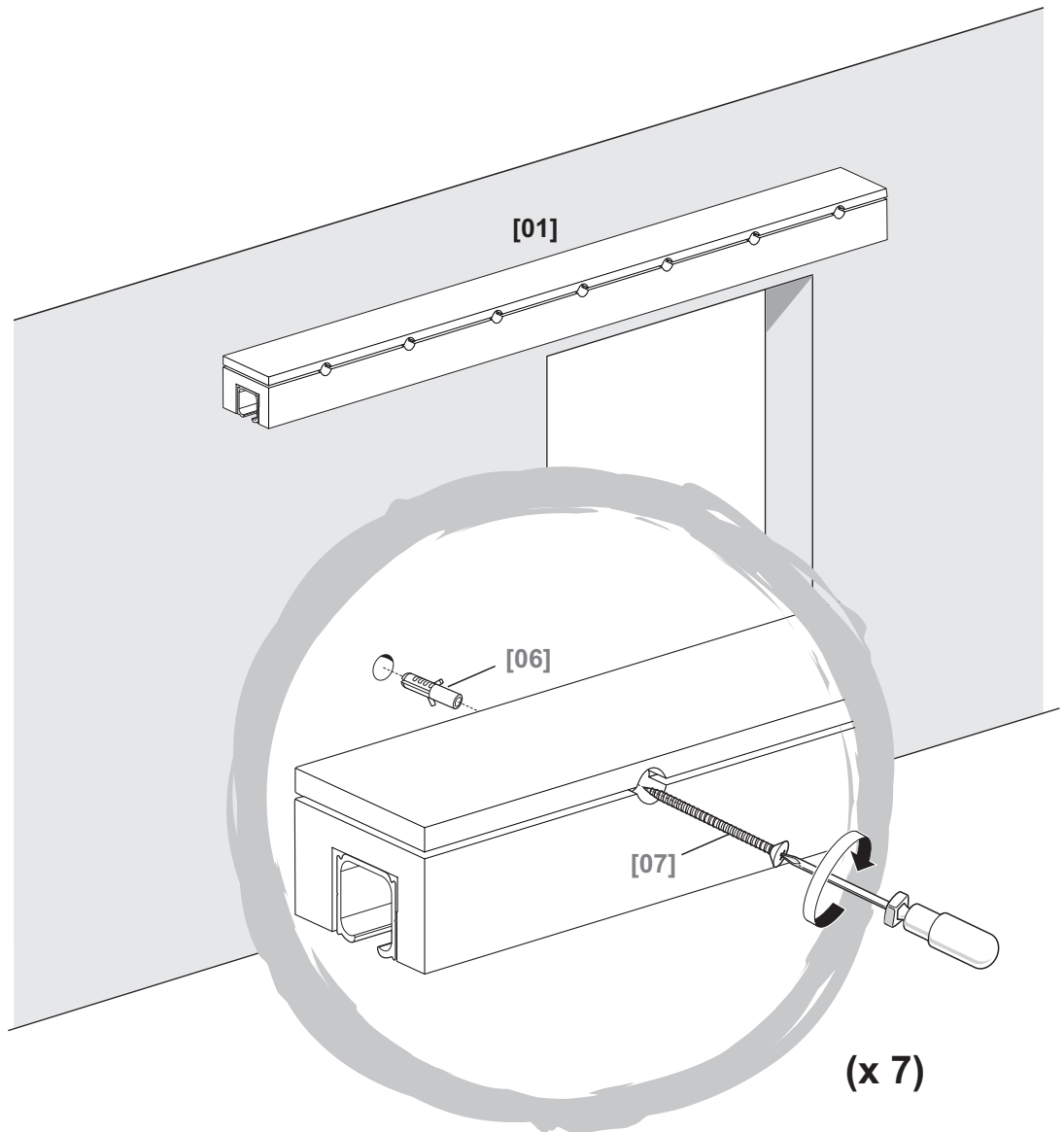

03



[16] x2

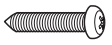

[17] x8
ST4.8x30

[21] x1

- EN Excluded
- DE Ausgeschlossen
- ES Excluidos
- FR Exclus
- RUS исключены
- PT Excluidos
- PL Wyłączone
- RO Exclude
- TR Dışlanan

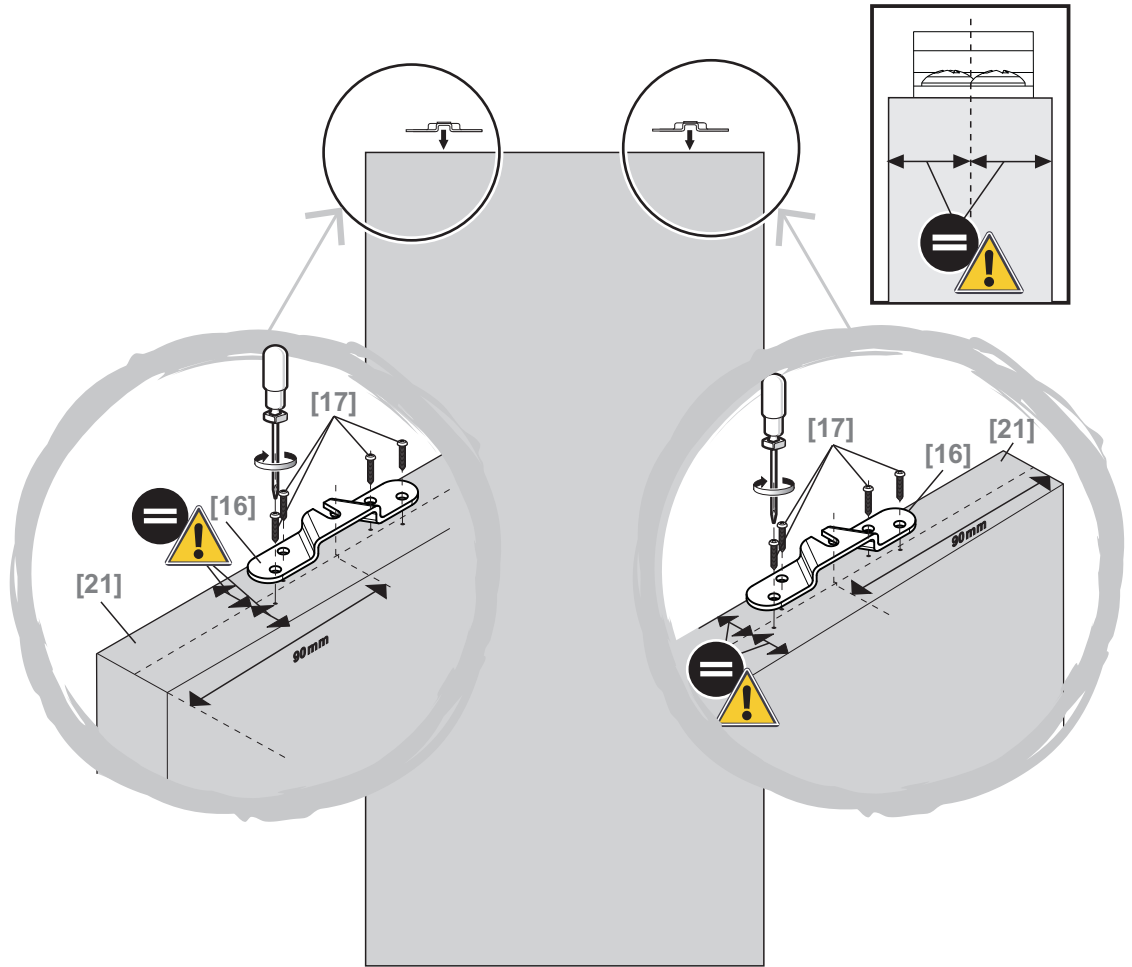

04

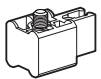

[12] x2

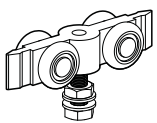

[15] x2

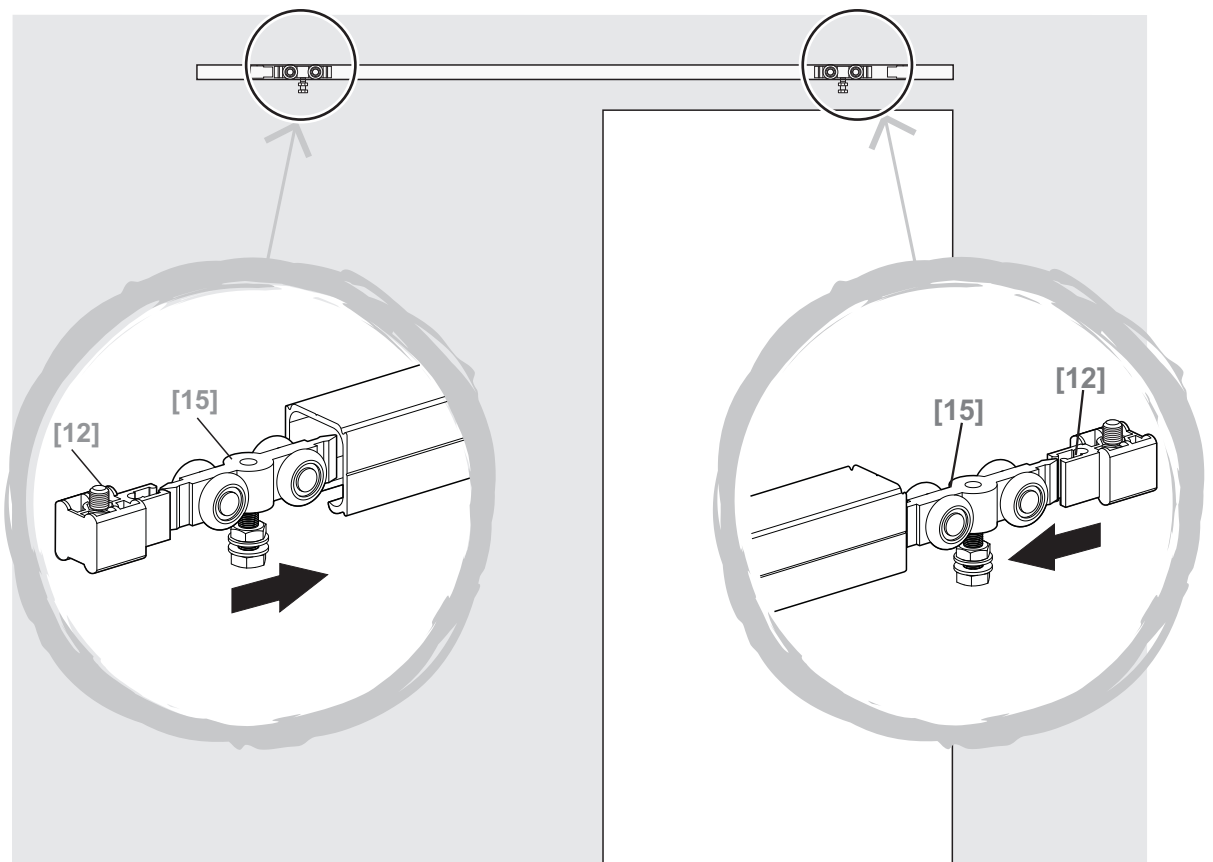

05



[13] x2

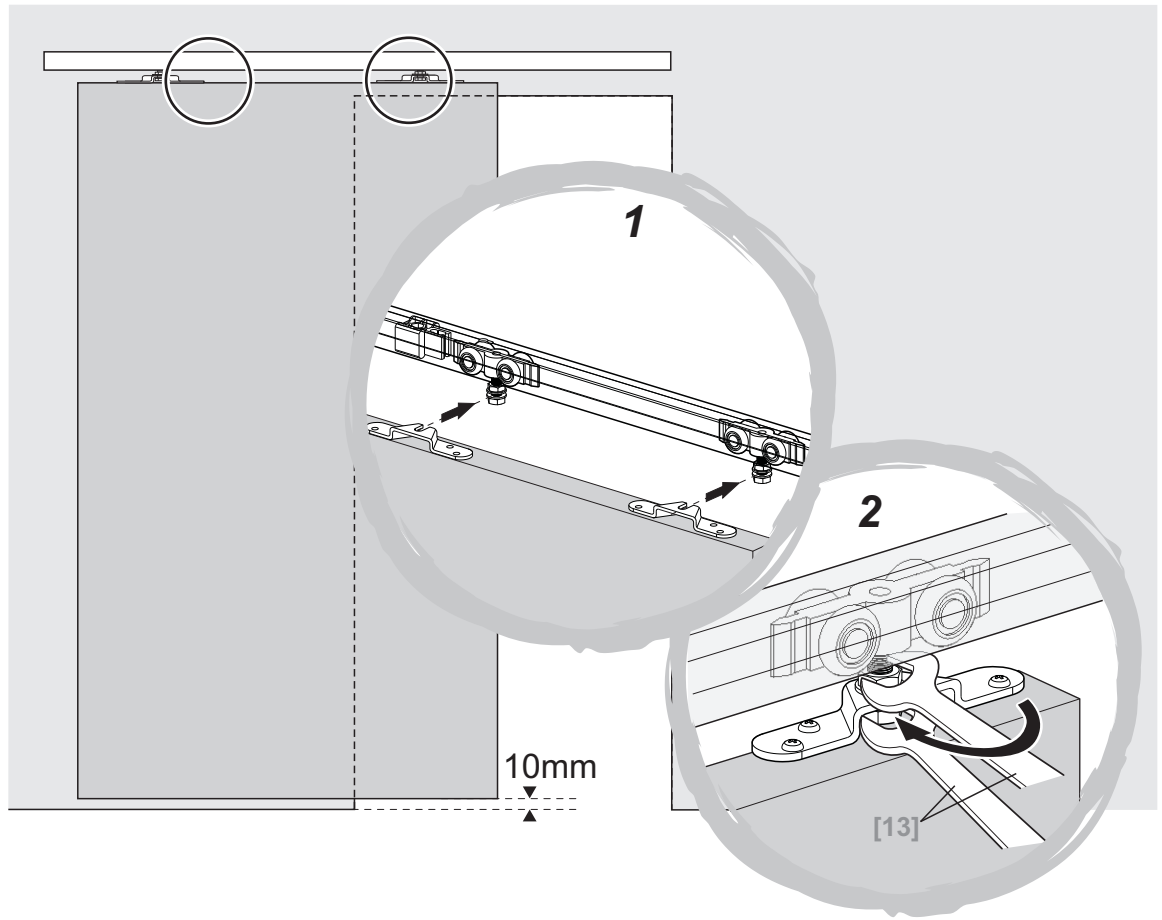

06

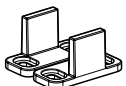

[18] x1



[19] x4

ST4.2x35



[20] x4

Ø8



[22] x1



[23] x2

ST4.2x25

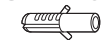

[24] x2

Ø8

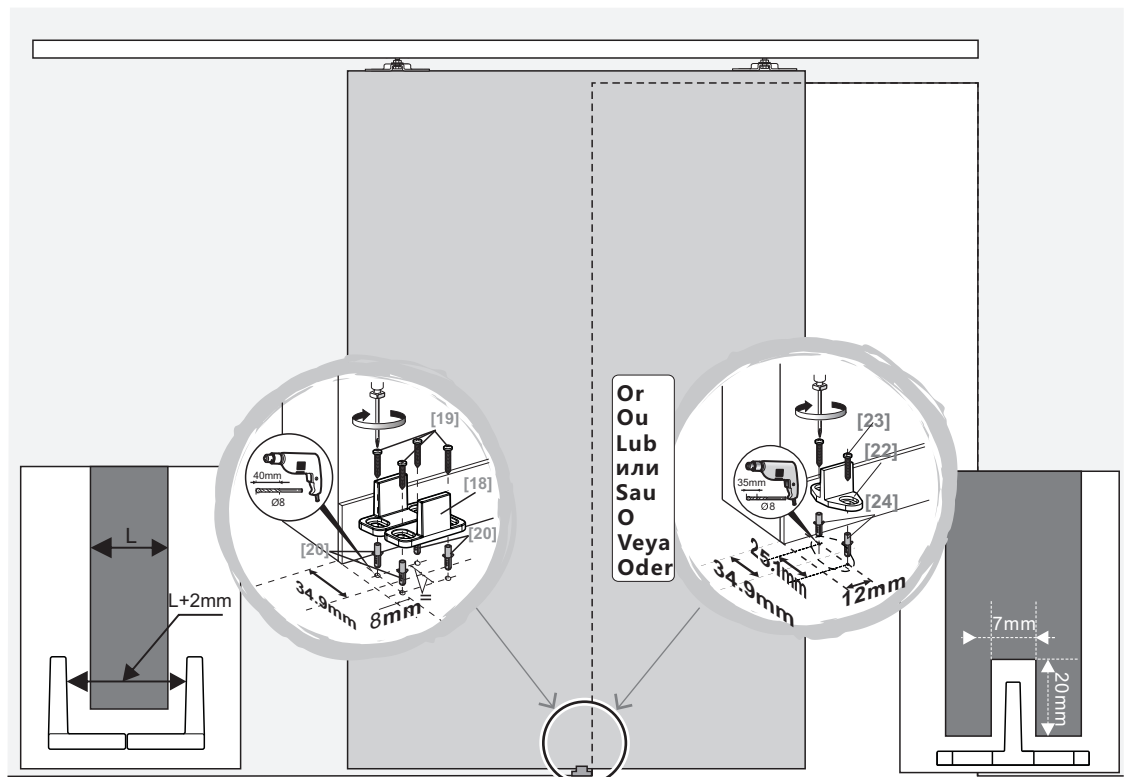

07

[14] x1
3mm

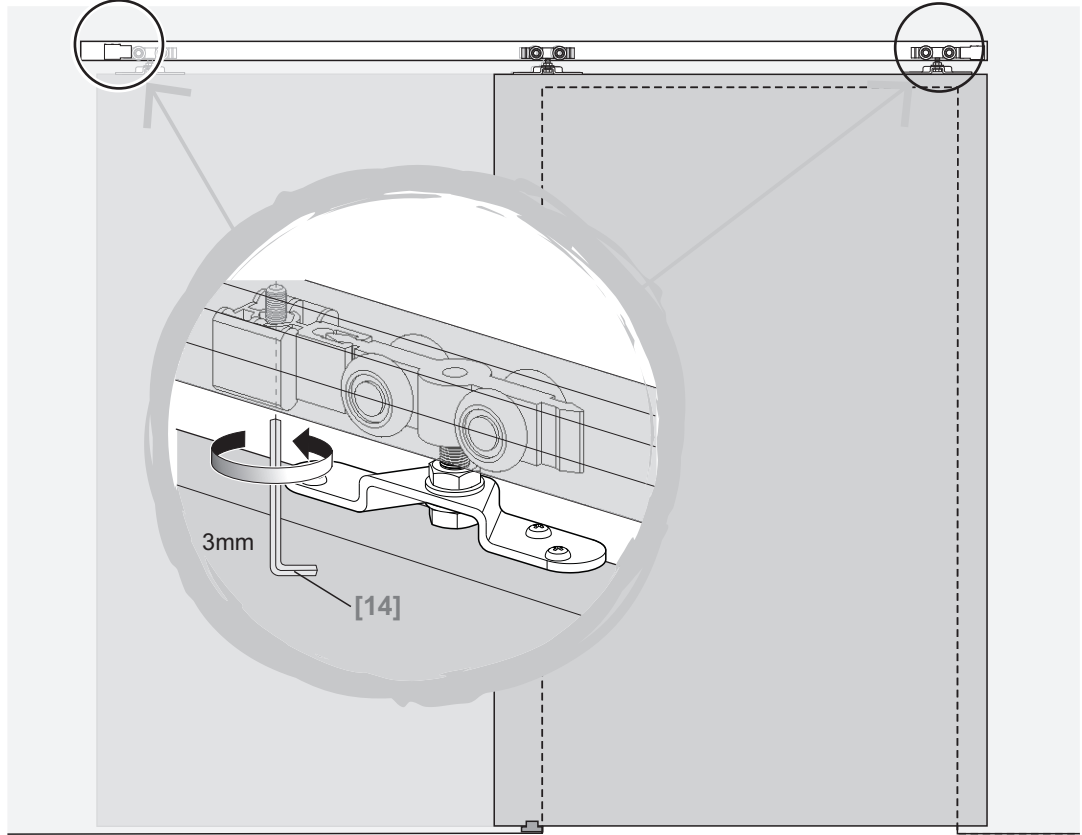

08

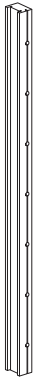

[04] x1



[06] x7
Ø8



[07] x7
M5x100

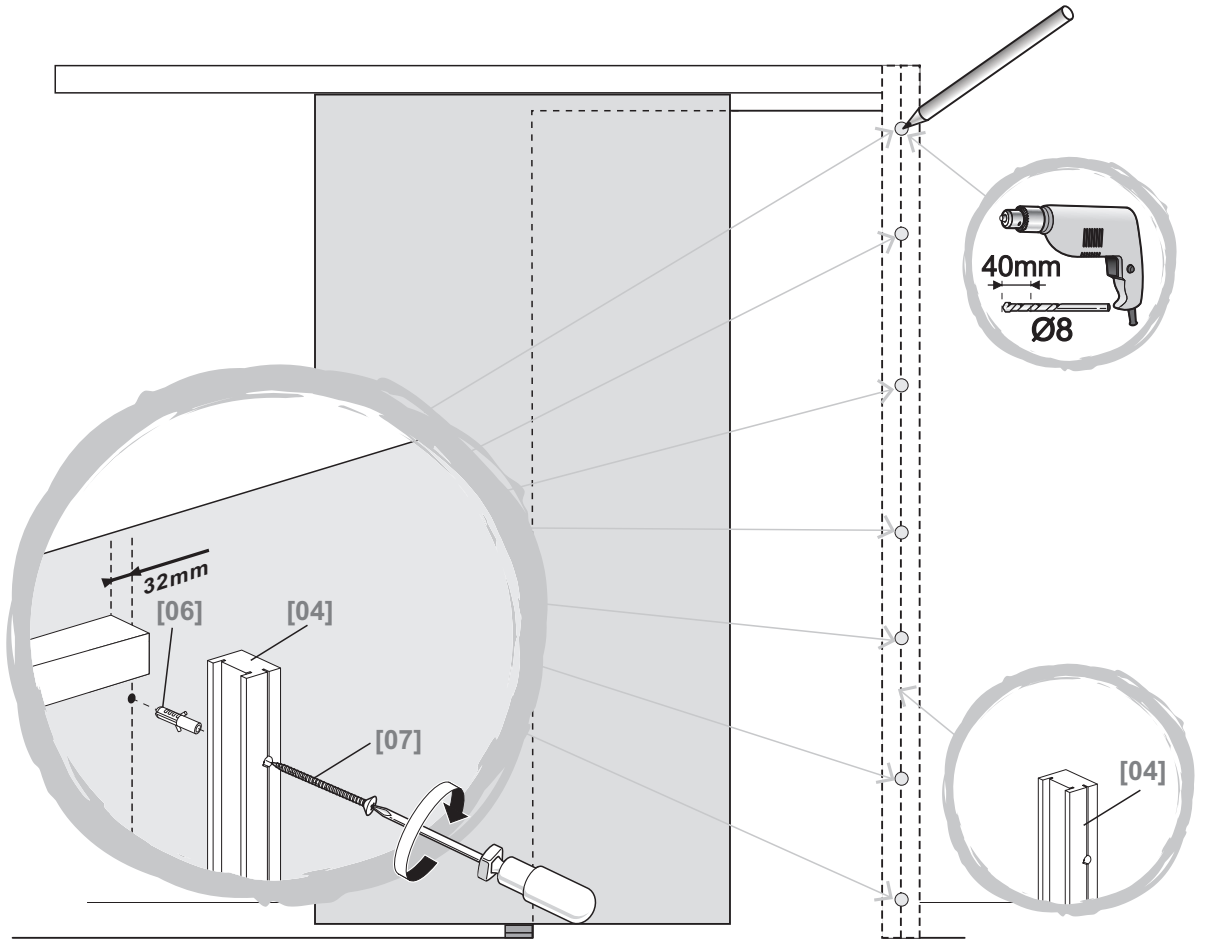

09

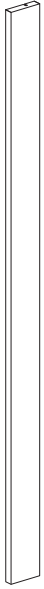

[05] x1



[11] x5

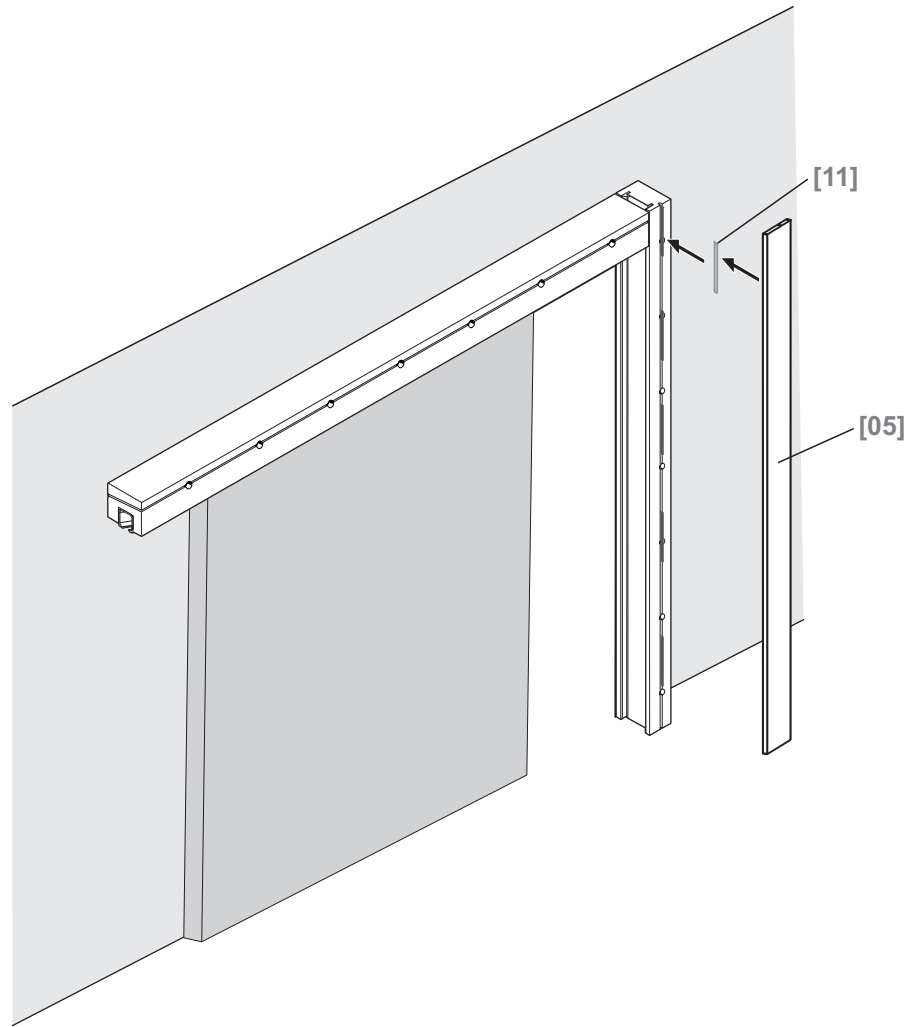

10

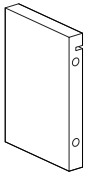

[08] x1



[09] x2



[10] x1

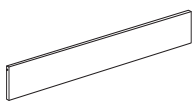

[02] x1



[03] x1

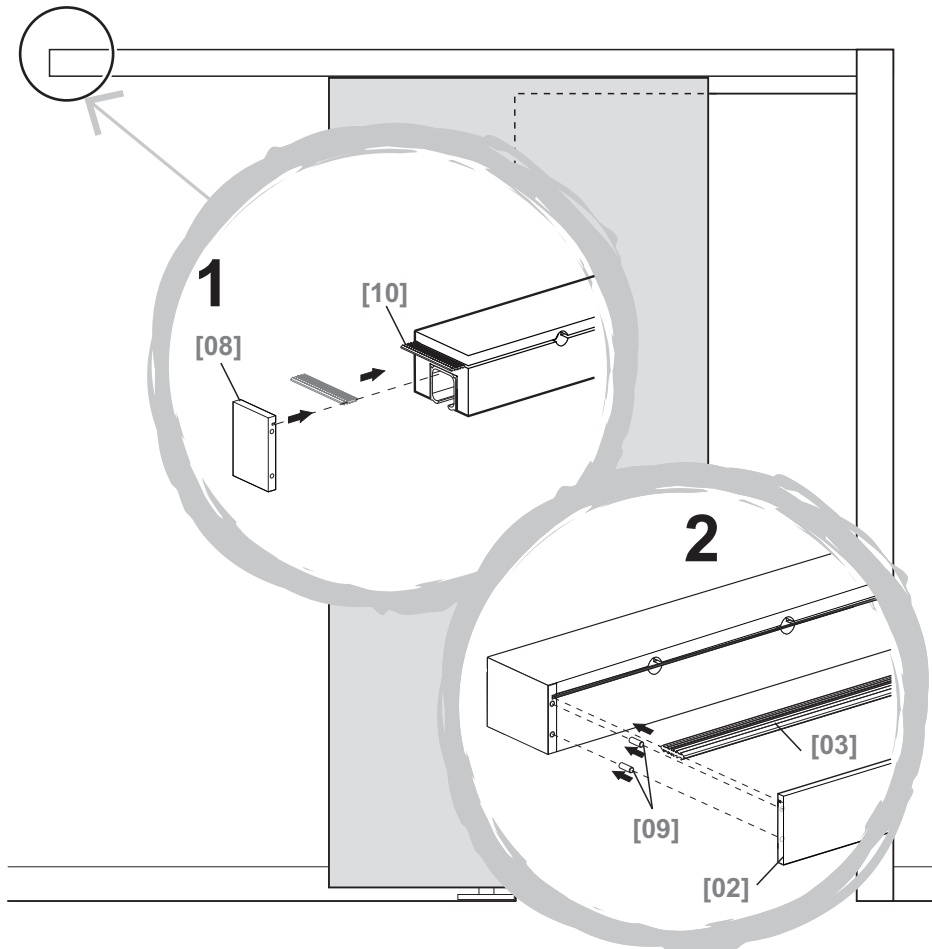

Kingfisher International Products Limited,
3 Sheldon Square, London, W2 6PX,
United Kingdom

EN Distributor:

B&Q plc, Chandlers Ford, Hants,
SO53 3LE United Kingdom www.diy.com

SFD Limited, Trade House, Mead Avenue,
Yeovil, BA22 8RT, United Kingdom

**Manufacturer, Fabricant, Hersteller,
Producator, Fabricante:**

Kingfisher International Products Limited,
3 Sheldon Square, London, W2 6PX,
United Kingdom

FR Distributeur:

Castorama France C.S. 50101
Templemars 59637 Wattignies CEDEX
www.castorama.fr

BRICO DÉPÔT 30-32 rue de la Tourelle
91310 Longpont-sur-Orge France
www.bricodepot.com

PL Dystrybutor:

Castorama Polska Sp. z o.o.
ul. Krakowiaków 78, 02-255 Warszawa
www.castorama.pl

DE Screwfix Direct Limited Mühlheimer
Straße 15363075 Offenbach/Main
www.screwfix.de

RUS Импортер:

ООО “Касторама РУС” Дербеневская
наб., дом 7, стр 8 Россия, Москва,
115114
www.castorama.ru

Изготовитель для России:

Нингбо Тенгью:

Адрес: № 1, строение 5, № 1, строение
4, № 1, строение 2, № 1, строение 1,
№ 1, Путошань Ист Роуд, Даки, район
Бэйлунь, Нинбо, Чжэцзян, Китай, 315819
Дата изготовления (месяц.год) см.
на упаковке

RO Distribuitor:

SC Bricostore România SA Calea Giulești
1-3, Sector 6, București România
www.bricodepot.ro

ES Distribuidor:

Euro Depot España, S.A.U. c/ La Selva,
10 - Edificio Inblau A 1a Planta 08820-El
Prat de Llobregat www.bricodepot.es

PT Distribuidor:

Brico Depot Portugal SA Rua Castilho,
5 - 1 esquerdo, sala 13 1250-066 Lisboa
www.bricodepot.pt

TR İthalatçı Firma:

KOÇTAŞ YAPI MARKETLERİ TİC. A.Ş.
Taşdelen Mah. Sırrı Çelik Bulvarı No:5
34788 Taşdelen/Çekmeköy/İSTANBUL
Tel: +90 216 4300300
Faks: +90 216 4844313
www.koctas.com.tr

Yetkili servis istasyonları ve yedek parça
temini için aşağıda yer alan Koçtaş Müşteri
Hattı ve Koçtaş Genel Müdürlük irtibat
bilgilerinden faydalanınız.

KOÇTAŞ MÜŞTERİ HİZMETLERİ
0850 209 50 50



**3663602776086 / 3663602776123 / 3663602776093 / 3663602776130 /
3663602776109 / 3663602776147 / 3663602776116**

Lugano / Levanto

V11117

EN

Safety instructions

- ☑ The instructions outlined below are intended to ensure your safety. Please read the safety manual and the instruction manual carefully before undertaking the sliding door system construction or mounting.
- ☑ Ensure that both the safety manual and instruction manual are retained for future reference.
- ☑ The sliding door system must be installed by a minimum of 3 adults who are proficient in the skills required to complete the task as outlined in the instruction manual.
- ☑ The mounting screws supplied are suitable for concrete and brick walls.
- ☑ Ensure safety eyewear is worn when drilling, chiseling and handling concrete.
- ☑ Ensure protective gloves are worn if handling concrete.
- ☑ Do not construct, mount or use this product if it damaged or elements are missing.
- ☑ Do not modify the construction or design of this product. Failure to follow this instruction could lead to injury, death or property damage.
- ☑ Refrain from using this sliding door system for anything other than its intended purpose.
- ☑ Ensure that you have all the tools specified in the instruction manual available before undertaking the sliding door system construction or mounting.
- ☑ This product is intended for indoor use only.
- ☑ This product is intended for domestic use only.
- ☑ Do not over tighten the screws, nuts or bolts provided. Check at least once a year that the screws, nuts or bolts are still safely tightened. Re-tighten them if needed.
- ☑ Handle any tool used carefully and in accordance with their instructions.
- ☑ Do not hang any load off the product.
- ☑ If there is any sign that the sliding system does not work properly or prone to be defective, please stop using this sliding system.
- ☑ Every six month check if all connections of components are in good condition.
- ☑ Every six month check if all fixations on the wall and fixations on the floor are in good condition.
- ☑ Do not slam the door too hard to extend the working life and avoid any accidental injuries.

Care & maintenance

- ☑ Use a soft damp cloth to clean the surface of the product. Wipe dry with a clean cloth.
- ☑ Never use any solvents, scourers, abrasives, bleach, acids, strong detergents, aggressive chemical cleaners or solvent-type cleaning solutions on the product.

IMPORTANT, RETAIN FOR FUTURE REFERENCE: READ CAREFULLY.

Manufacturer:

Kingfisher International Products Limited,
3 Sheldon Square, London, W2 6PX,
United Kingdom

Distributor:

B&Q plc, Chandlers Ford, Hants, SO53 3LE
United Kingdom www.diy.com
SFD Limited, Trade House, Mead Avenue,
Yeovil, BA22 8RT, United Kingdom

FR

Consignes de sécurité

- ☑ Les consignes décrites ci-dessous visent à assurer votre sécurité.
- ☑ Veuillez lire attentivement le manuel de sécurité et le manuel d'instructions avant de commencer la construction ou le montage du système de porte coulissante.
- ☑ Conservez le manuel de sécurité et le manuel d'instructions pour une utilisation ultérieure.
- ☑ Le système de porte coulissante doit être installé par au minimum 3 adultes, expérimentés pour effectuer ce travail, tel que mentionné dans le manuel d'instructions.
- ☑ Les vis et chevilles de fixation fournies sont adaptées aux murs en béton et en brique. Pour des murs constitués d'autres matériaux, utilisez des vis et des chevilles adaptées.
- ☑ Portez des lunettes de sécurité lorsque vous percez, burinez et manipulez du béton.
- ☑ Portez des gants de protection lorsque vous manipulez du béton.
- ☑ Ne construisez pas, ne posez pas et n'utilisez pas ce produit s'il est endommagé ou si des éléments sont manquants.
- ☑ Ne modifiez pas la construction ni la conception de ce produit. Le non-respect de cette consigne peut entraîner des dégâts matériels, des blessures, voire la mort.
- ☑ N'utilisez pas ce système de porte coulissante pour un autre usage que celui pour lequel il est prévu.
- ☑ Assurez-vous de disposer des outils spécifiés dans le manuel d'instructions avant de commencer la construction ou le montage du système de porte coulissante.
- ☑ Ce produit est destiné à un usage intérieur uniquement.
- ☑ Ce produit est destiné à un usage domestique uniquement.
- ☑ Ne serrez pas trop les vis, écrous et boulons fournis. Contrôlez au moins une fois par an que les vis, écrous et boulons sont toujours suffisamment serrés. Re-serrez-les si besoin.
- ☑ Manipulez les outils avec précaution et conformément aux instructions d'utilisation.
- ☑ Ne suspendez aucune charge sur le produit.
- ☑ En cas de signe indiquant que le système de porte coulissante ne fonctionne pas correctement ou est susceptible d'être défectueux, veuillez cesser d'utiliser ce système de porte coulissante.
- ☑ Vérifiez une fois tous les six mois si toutes les connexions entre les composants sont en bon état.
- ☑ Vérifiez une fois tous les six mois si toutes les fixations sur les murs et sur le sol sont en bon état.
- ☑ Afin de prolonger la durée de vie de la porte et d'éviter toute blessure accidentelle, ne fermez pas la porte trop violemment.

Entretien et maintenance

- ☑ Nettoyez la surface du produit à l'aide d'un chiffon doux et humide. Essuyez à l'aide d'un chiffon propre.
- ☑ N'utilisez jamais de solvant, tampon à récurer, matériau abrasif, eau de Javel, acide, détergent puissant, produit nettoyant chimique agressif ou solution de nettoyage à base de solvant pour nettoyer le produit.

IMPORTANT – A CONSERVER POUR DE FUTURS BESOINS DE REFERENCE : A LIRE SOIGNEUSEMENT.

Fabricant :

Kingfisher International Products Limited,
3 Sheldon Square, London, W2 6PX,
United Kingdom

Distributeur :

Castorama France C.S.
50101 Templemars
59637 Wattignies CEDEX
www.castorama.fr

BRICO DÉPÔT 30-32 rue de la
Tourelle
91310 Longpont-sur-Orge France
www.bricodepot.com