

MANUALE DELLE ISTRUZIONI PER L'USO - RADIATORE ELETTRICO pag. 1

INSTRUCTIONS - ELECTRIC RADIATOR page 13

MODE D'EMPLOI - RADIATEUR ÉLECTRIQUE page 25

INSTRUKCJA OBSŁUGI ELEKTRYCZNEGO - GRZEJNIK ELEKTRYCZNY str. 37

MANUAL CU INSTRUȚIUNI DE UTILIZARE - CALORIFER ELECTRIC pag. 49

IT

GB

FR

PL

RO

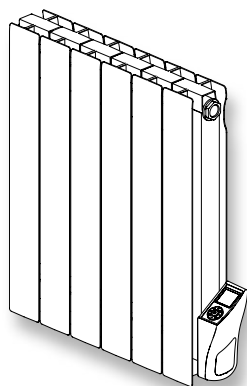

V20121 BX220IM

FIG. / RYS. 1

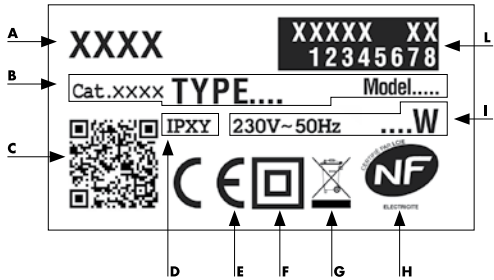
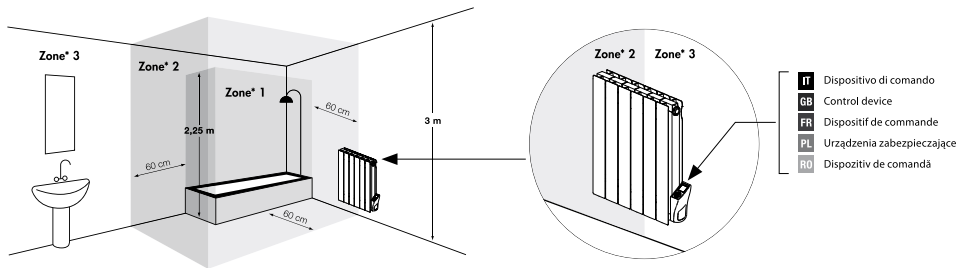

FIG. / RYS. 2



* Zona / Zone / Strefa / Zonă

FIG. / RYS. 3

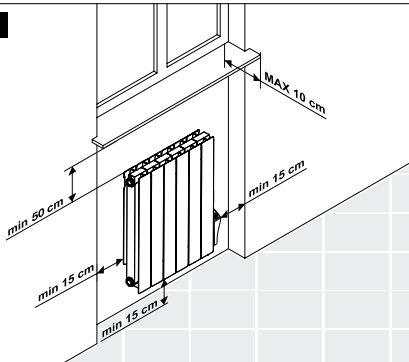

FIG. / RYS. 4

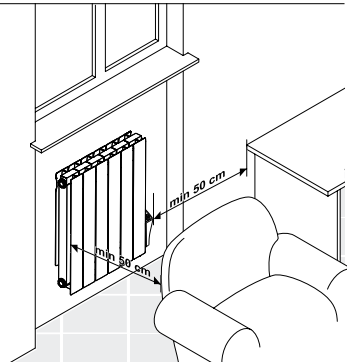

FIG. / RYS. 5

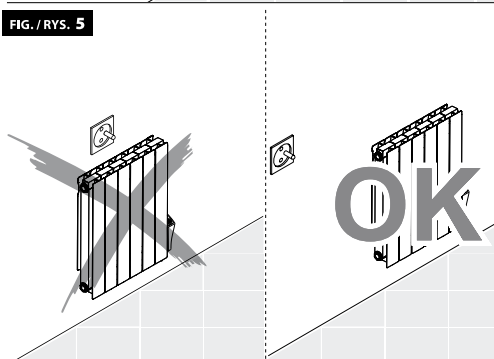

FIG. / RYS. 6

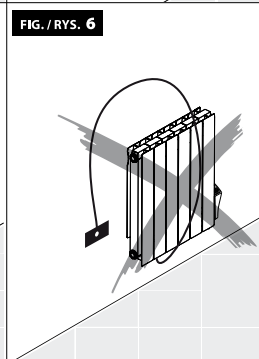

FIG. / RYS. 7

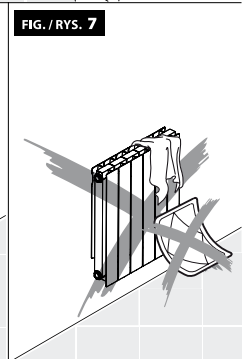

FIG. / RYS. 1

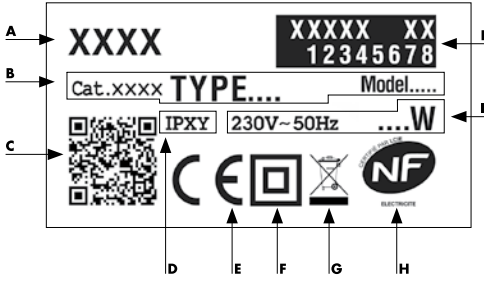
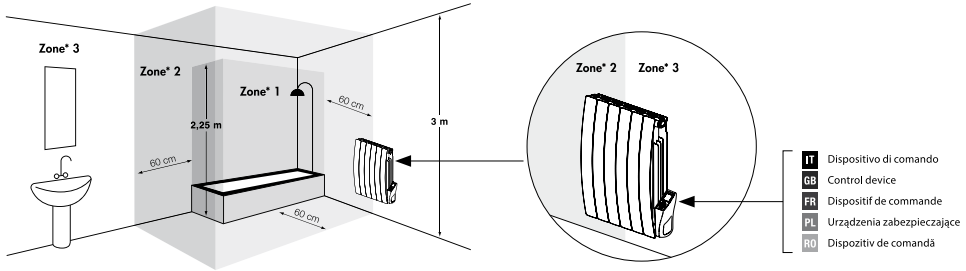

FIG. / RYS. 2



* Zona / Zone / Strefa / Zonă

FIG. / RYS. 3

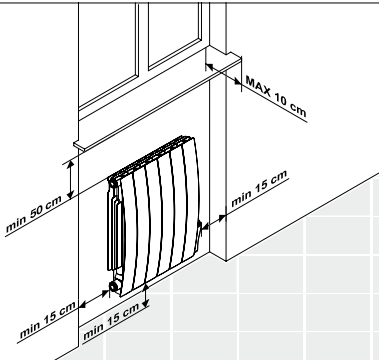

FIG. / RYS. 4

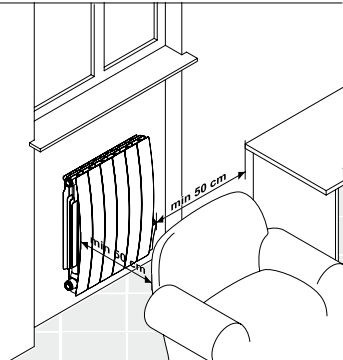

FIG. / RYS. 5

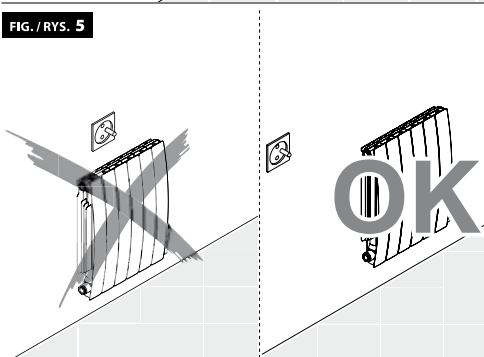

FIG. / RYS. 6

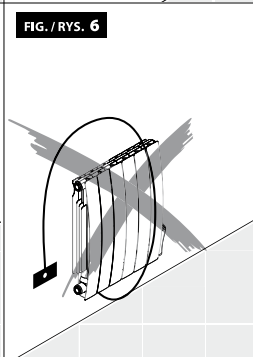
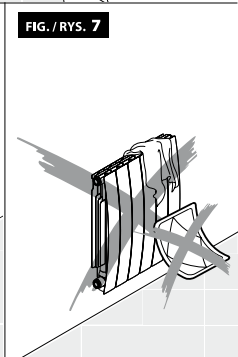
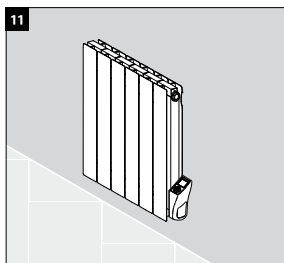
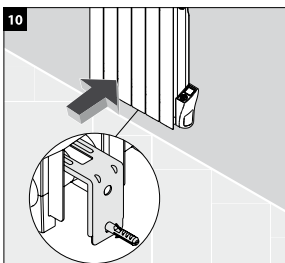
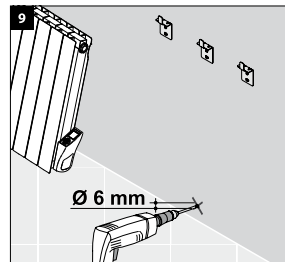
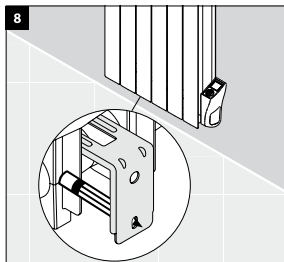
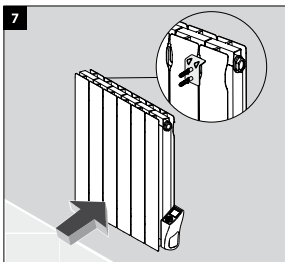
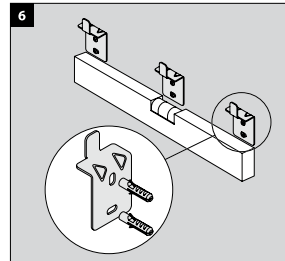
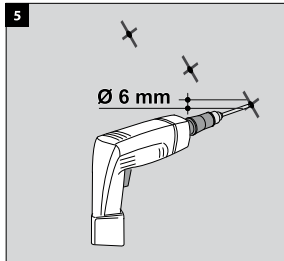
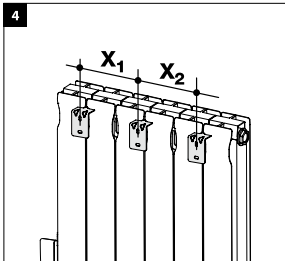
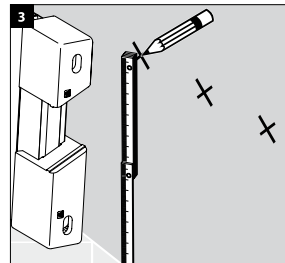
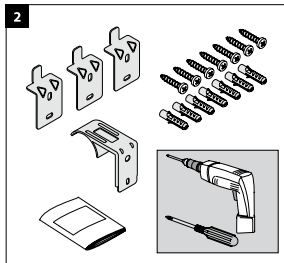
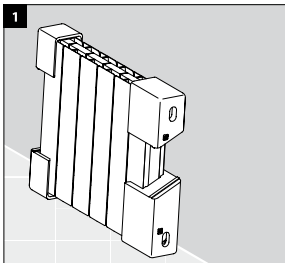

FIG. / RYS. 7



SCHEMA 1 / SCHEME 1 / SCHÉMA 1 / SCHEMAT 1

Potenza / Power / Puissance / Moc / Putere (W)	N° Elementi / N° Elements / N° Eléments / N° Elementy	N° Mensole inferiori / N° Lower brackets / N° Supports inférieurs / L.ba dolných podpórek / Nr. cleme de fixare inferioare	N° Mensole superiori / N° Upper brackets / N° Supports supérieurs / L.ba górnych podpórek / Nr. cleme de fixare superioare	X ₁ (cm)	X ₂ (cm)	X ₃ (cm)
1000	6	1	3	16,1	16,1	/
1500	9	1	3	32,2	24,2	/
2000	12	2	4	24,2	32,2	24,2



SCHEMA 1 / SCHEME 1 / SCHÉMA 1 / SCHEMAT 1

Potenza / Power / Puissance / Moc / Putere (W)	N° Elementi / N° Elements / N° Eléments / N° Elementy	X (cm)
1000	6	32,2
1500	9	56,3
1800	11	72,4

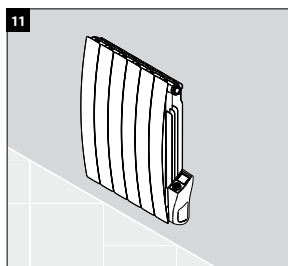
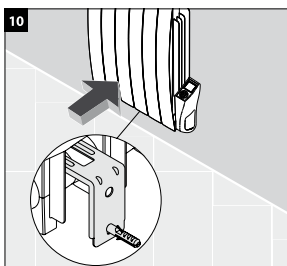
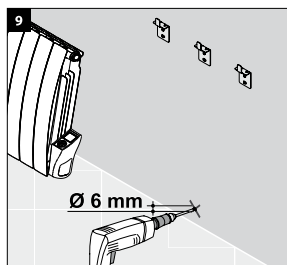
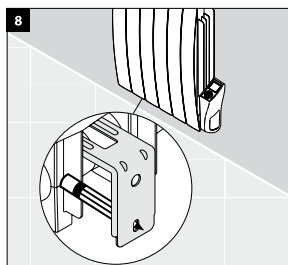
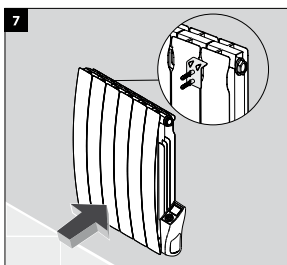
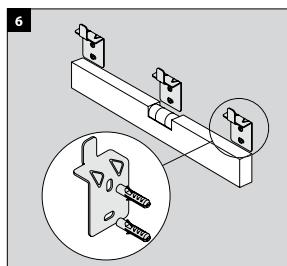
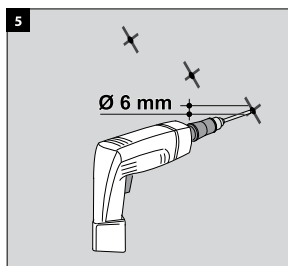
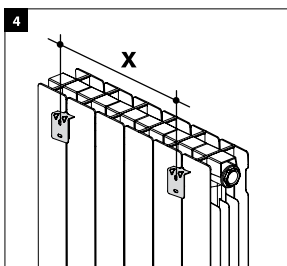
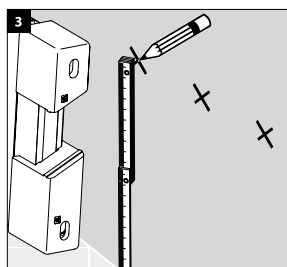
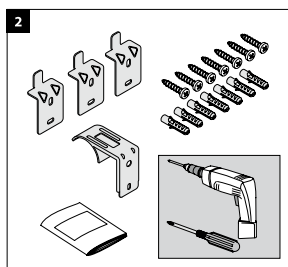
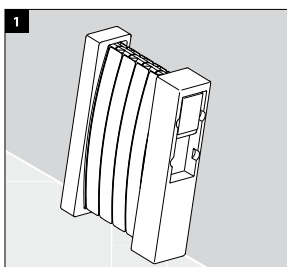

SCHEMA 1 / SCHEME 1 / SCHÉMA 1 / SCHEMAT 1

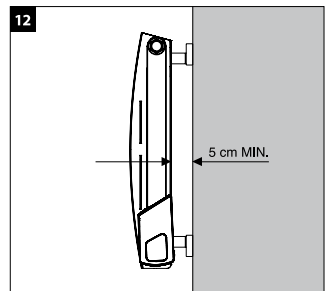
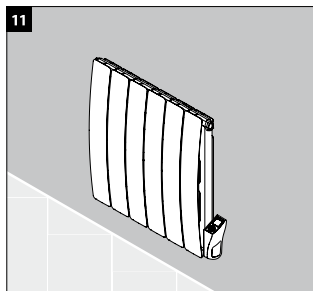
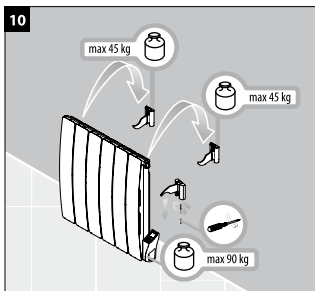
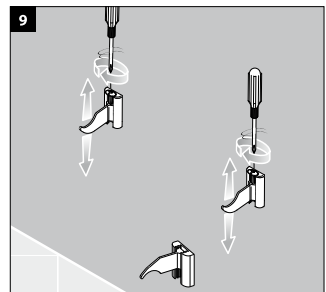
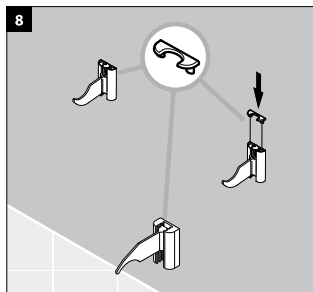
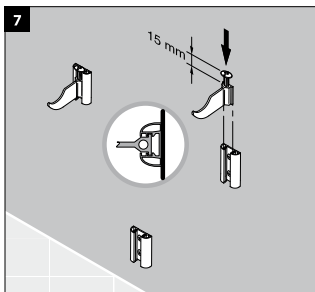
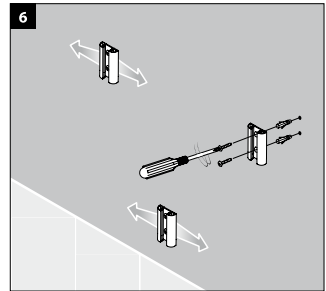
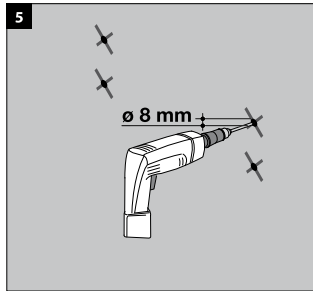
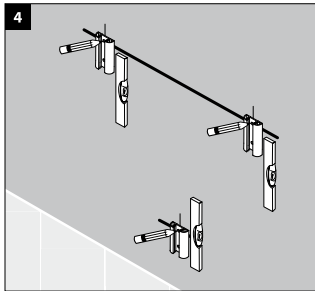
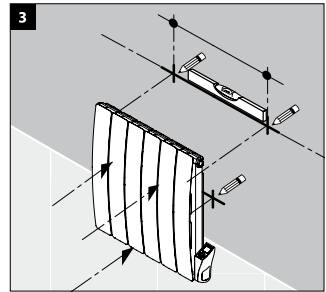
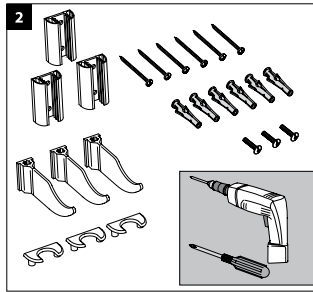
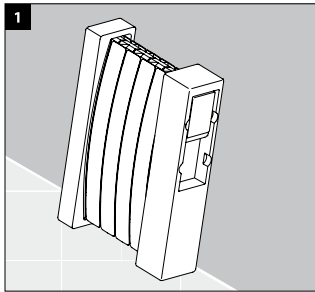

SIMBOLOGIA USATA NEL MANUALE



ATTENZIONE!
PERICOLO PER LA SICUREZZA DELLE PERSONE,
DEGLI ANIMALI DOMESTICI E DEI BENI.



ATTENZIONE!
PERICOLO DI SCOSSA ELETTRICA.



ATTENZIONE!
PERICOLO DI DANNI AL PRODOTTO.



ATTENZIONE!
TEMPERATURE ELEVATE.
PERICOLO DI SCOTTATURA.



CONSIGLIO PER IL BUON
FUNZIONAMENTO.



NON COPRIRE!

ATTENZIONE



AVVERTIMENTO - Alcune parti di questo prodotto possono diventare molto calde ed essere causa di scottature. Particolare attenzione deve essere prestata in presenza di bambini o persone vulnerabili.



I bambini di età inferiore ai 3 anni, se non sorvegliati, devono essere tenuti a distanza dal radiatore.

I bambini di età compresa tra 3 e 8 anni dovrebbero poter esclusivamente accendere / spegnere l'apparecchio, posto che questo sia installato nella sua normale posizione di funzionamento ed essi siano sorvegliati o siano stati adeguatamente istruiti sull'uso in sicurezza dell'apparecchio, avendo compreso i rischi connessi al suo utilizzo.

I bambini di età compresa tra 3 e 8 anni non devono disconnettere, regolare o pulire l'apparecchio, nè effettuarne la manutenzione.

L'apparecchio può essere utilizzato da bambini di età non inferiore a 8 anni e da persone con ridotte capacità fisiche, sensoriali o mentali, o prive di esperienza o della necessaria conoscenza, purché sotto sorveglianza oppure dopo che le stesse abbiano ricevuto istruzioni relative all'uso sicuro dell'apparecchio e alla comprensione dei pericoli ad esso inerenti. I bambini non devono giocare con l'apparecchio. La pulizia e la manutenzione destinata ad essere effettuata dall'utilizzatore non deve essere effettuata da bambini senza sorveglianza.



Non installare l'apparecchio:
- immediatamente sotto o davanti ad una presa di corrente o ad una scatola di derivazione (Fig. 5)
- a contatto con il muro o con il pavimento
- vicino a tende, altri materiali infiammabili, combustibili o recipienti in pressione.



ATTENZIONE:
Rispettare le distanze indicate nelle figure 3,4.



Installare e utilizzare l'apparecchio solo come indicato nelle presenti istruzioni.



Se il cavo di alimentazione è danneggiato, deve essere sostituito dal costruttore o dal suo servizio di assistenza tecnica o da altro personale qualificato al fine di evitare un pericolo. Non utilizzare l'apparecchio se lo stesso o il controllo elettronico sono danneggiati.



Assicurarsi che la linea di alimentazione sia dotata di un dispositivo che permetta il sezionamento dell'apparecchio dalla rete domestica, incluso il Filo Pilota, quando presente, secondo la normativa vigente.



ATTENZIONE: per evitare surriscaldamenti pericolosi non coprire in nessun caso l'apparecchio (Fig.7). Non ostruire il flusso dell'aria inserendo materiali all'interno.



Per la rottamazione dell'apparecchio seguire la normativa vigente per lo smaltimento e la gestione dei rifiuti.

1. CARATTERISTICHE DELL'APPARECCHIO

Tensione di alimentazione: 230 V ~ 50 Hz

Classe di isolamento: II 

Grado di protezione: IPX4

TYPE	Potenza [W]	Lunghezza [cm]	Altezza [cm]	Peso [kg]	Corrente Nominale [A]
CVE0610F	1000	55	58	16	4,5
CVE0915F	1500	79	58	24	6,5
CVE1220F	2000	104	58	32	9
DVE0610F	1000	55	58	11	4,5
DVE0915F	1500	79	58	16	6,5
DVE1118F	1800	95	58	19	8
EVE0610F	1000	55	58	17	4,5
EVE0915F	1500	79	58	25	6,5
EVE1220F	2000	103	58	33	9

Tabella 1



I dati tecnici dell'apparecchio sono indicati nell'etichetta caratteristica posta sul lato del radiatore (Fig. 1).

- | | | | |
|---|----------------------------|---|-------------------------------------|
| A | Marchio/Fabbricante | F | Doppio isolamento |
| B | Modello, type, categoria | G | Modalità di smaltimento |
| C | Codice Bidimensionale (QR) | H | Marchi di Qualità |
| D | Grado di protezione | I | Tensione di alimentazione e Potenza |
| E | Marcatura CE | L | Numero di serie |

2. INFORMAZIONI GENERALI



Disimballare l'apparecchio con cura, appoggiarlo sugli angolari in polistirolo o su un tappeto.

Il contenuto dell'imballo è:

- l'apparecchio
- kit di fissaggio
- manuale d'istruzione



Leggere attentamente e integralmente le istruzioni prima dell'installazione e dell'uso. Conservarle inoltre per consultazioni future.



Installare e utilizzare l'apparecchio solo come indicato nelle presenti istruzioni.



Queste istruzioni non coprono ogni possibile situazione che possa presentarsi. Fare sempre ricorso al buon senso e alla prudenza nell'installazione, nel funzionamento e nella conservazione dell'apparecchio.



È vietato alterare in qualsiasi modo le caratteristiche dell'apparecchio e rimuovere qualsiasi parte fissa compresi i tappi. Assicurarsi che l'apparecchio sia integro. Non utilizzare l'apparecchio se danneggiato, ma contattare il rivenditore o personale qualificato.



I materiali utilizzati per l'imballaggio sono riciclabili. Si consiglia quindi di riporli negli appositi contenitori per la raccolta differenziata.

3. POSIZIONAMENTO ED INSTALLAZIONE



L'apparecchio è costruito per il riscaldamento dei locali ad uso domestico o simile. Non deve essere adoperato per altri scopi.

L'apparecchio deve essere utilizzato per l'installazione fissa a parete, come prescritto nelle presenti istruzioni. Installare l'apparecchio con il termostato posizionato in basso (Fig. 2).



Nella stanza da bagno (dotata di vasca o di doccia) installare l'apparecchio al di fuori della zona 1.

Installare l'apparecchio in modo tale che il controllo elettronico e gli altri dispositivi di comando non possano essere toccati da una persona che si trovi nella vasca da bagno o nella doccia. È vietato l'utilizzo di spina per il collegamento del radiatore.



Per i radiatori già provvisti di spina seguire le avvertenze riportate a pag 11.



Rispettare le distanze indicate nelle figure 3,4.



Non installare l'apparecchio:

- immediatamente sotto o davanti ad una presa di corrente o ad una scatola di derivazione (Fig. 5)
- a contatto con il muro o con il pavimento
- vicino a tende, altri materiali infiammabili, combustibili o recipienti in pressione.



Verificare che non ci siano tubi o cavi elettrici all'interno della parete che possano essere danneggiati durante il fissaggio.



L'apparecchio è equipaggiato con un sensore in grado di rilevare l'apertura di una eventuale finestra presente sopra di esso. Per il corretto funzionamento della funzione "Finestra Aperta" si consiglia di verificare e di attenersi alle prescrizioni riportate nel Cap. 4.3.2 prima del fissaggio a parete.

3.1 FISSAGGIO A PARETE



Assicurarsi che le viti e i tasselli inclusi nella confezione di fissaggio siano adatti al tipo di parete su cui verrà installato l'apparecchio. Per qualsiasi dubbio rivolgersi a personale qualificato o al rivenditore.



Seguire la sequenza d'installazione presente nell'anta pieghevole della copertina (Schema 1), rispettando la distanza minima tra la parte inferiore del radiatore ed il pavimento (Fig. 3).



Durante l'installazione assicurarsi che il cavo di alimentazione sia scollegato dalla linea elettrica.

3.2 COLLEGAMENTO ELETTRICO



ATTENZIONE

L'installazione va fatta eseguire a un tecnico specializzato e in conformità con le norme vigenti nel rispettivo paese.

Quando l'apparecchio viene installato, assicurarsi che non sia alimentato elettricamente e che l'interruttore generale dell'impianto sia aperto in posizione "0".



L'alimentazione dell'apparecchio è a 230 V ~ 50 Hz. Assicurarsi che la linea elettrica sia adeguata ai dati riportati in tabella 1.



Assicurarsi che la linea di alimentazione sia dotata di un dispositivo che permetta il sezionamento dell'apparecchio dalla rete domestica, incluso il Filo Pilota, quando presente, secondo la normativa vigente.

In caso di installazione in locali da bagno la linea elettrica deve essere dotata di un dispositivo di protezione differenziale ad alta sensibilità con corrente nominale differenziale di intervento di 30 mA.

La linea di alimentazione e la centralina del Filo Pilota devono essere protetti con il medesimo differenziale.

Realizzare la connessione elettrica all'interno di una scatola di derivazione.

Nel caso di locali umidi (cucina, bagno) il collegamento dell'apparecchio al circuito deve essere localizzato ad almeno 25 cm dal pavimento.

Rispettare rigorosamente lo schema di collegamento elettrico riportato nella figura 8.



Se il Filo Pilota non è collegato alla centralina di programmazione, va terminato ed isolato. Non collegare in alcun caso il Filo Pilota a terra.



Assicurarsi che il cavo di alimentazione non possa in nessun modo entrare in contatto con la superficie dell'apparecchio (Fig.6).

4. REGOLAZIONE E FUNZIONAMENTO



L'apparecchio è costruito per riscaldare l'ambiente. Alcune parti di questo prodotto possono diventare molto calde ed essere causa di scottature. Particolare attenzione deve essere prestata in presenza di bambini o persone vulnerabili.



Mantenere materiali combustibili, infiammabili e i recipienti in pressione (ad esempio bombolette spray, estintori) ad almeno 50 cm dall'apparecchio. Non vaporizzare sostanze di alcun tipo sulla superficie.



Non toccare l'apparecchio con le mani o i piedi bagnati o umidi. Non bagnare il controllo elettronico con acqua o altri liquidi. Nel caso in cui dovesse succedere staccare l'alimentazione di corrente e lasciar asciugare completamente l'apparecchio.



L'installazione dell'apparecchio ad altitudini elevate provoca un aumento della temperatura dell'aria riscaldata.



In occasione della prima accensione è normale che l'apparecchio rilasci odore che sparirà in breve tempo. Si consiglia di arieggiare l'ambiente dopo il primo utilizzo.



Durante l'accensione dell'apparecchio in ambienti freddi è possibile che questo emetta dei rumori metallici, dovuti alla dilatazione dei materiali.



Qualora in fase di fissaggio o in occasione delle prime accensioni si riscontrasse la presenza di tracce oleose nella parte inferiore dell'apparecchio, potrebbe trattarsi di un residuo di lavorazione. Ripulire la parte con le dovute precauzioni, ad intervalli di un paio di giorni. Se il fenomeno persiste, seguire le indicazioni riportate nel Cap. 7.

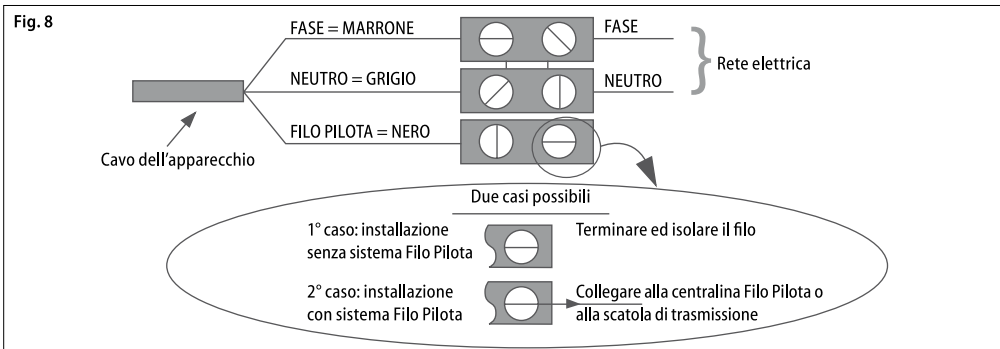

UTILIZZO DEL RADIATORE DAL PANNELLO DI CONTROLLO:

PANNELLO DI CONTROLLO

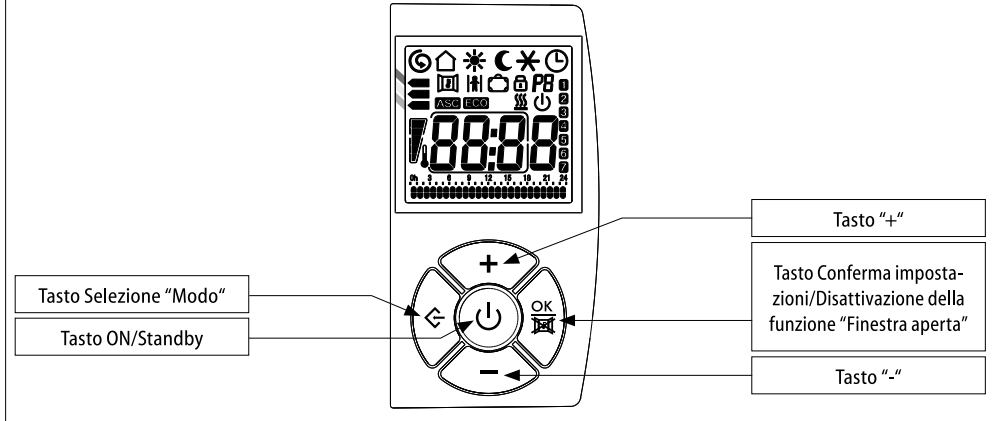

DISPLAY

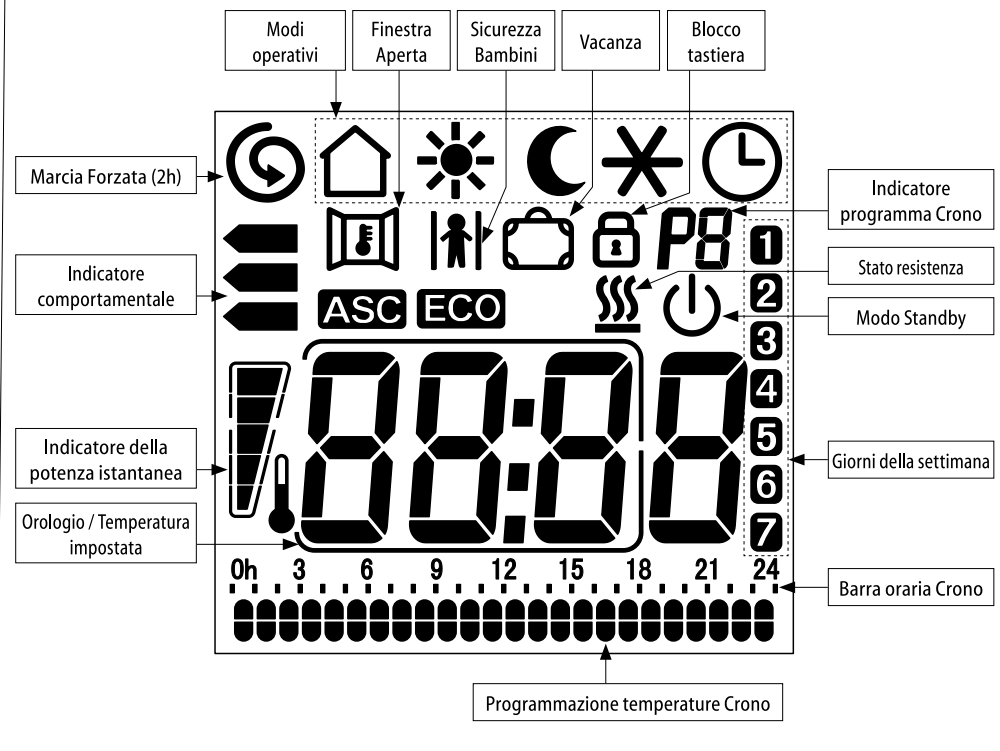

4.1 MODE ON/STANDBY



Nel modo "Standby" il display visualizza l'icona , l'ora e il giorno della settimana. Tutti i modi, compreso il "Filo Pilota", sono sospesi, ma l'apparecchio rimane sotto tensione in attesa della ricezione di un comando.



Per accendere o spegnere l'apparecchio premere il tasto "Standby". Il radiatore si accende nel modo operativo precedente lo spegnimento ed emette segnale acustico.

Il display visualizza l'ora in modo "Crono", mentre negli altri modi visualizza la temperatura impostata.







L'apparecchio avvisa con un doppio segnale acustico l'ingresso nel modo "Standby" e con un segnale acustico prolungato l'uscita da questo.

4.2 MODI OPERATIVI

L'apparecchio mette a disposizione 6 modi operativi che consentono di riscaldare l'ambiente nel modo più appropriato alle proprie esigenze.



Premere il tasto "Modo" per scegliere il modo operativo desiderato. Un'icona sul display indica il modo operativo:

	Filo Pilota		Comfort
	Notte/Eco		Anti-Gelo
	Crono		Energy Saving



FILO PILOTA

La temperatura è programmata attraverso i comandi del "Filo Pilota".
Tutti i comandi del "Filo Pilota" sono attivati.



COMFORT

La temperatura di "Comfort" corrisponde alla temperatura desiderata dal cliente.
Tutti i comandi "Filo Pilota" sono disattivati.



NOTTE/ECO

Il modo "Notte/Eco" mantiene una temperatura confortevole con un ridotto consumo di energia.
Tutti i comandi "Filo Pilota" sono disattivati.



ANTI-GELO

In modalità "Anti-Gelo" la temperatura minima è fissata a 7 °C.
L'apparecchio si accende automaticamente per temperature ambiente inferiori ai 7 °C.
Tutti i comandi "Filo Pilota" sono disattivati.



CRONO

Questo modo consente di selezionare uno dei tre programmi di cronotermostatazione preimpostati, oppure il programma personalizzabile. Quest'ultimo consente una programmazione giornaliera e settimanale, con due livelli di temperatura ("Comfort" e "Notte/Eco").
Tutti i comandi "Filo Pilota" sono disattivati.



ENERGY SAVING

Questo modo consente di ridurre i consumi, nel caso in cui la stanza venga lasciata vuota. La temperatura è fissata a 17 °C.
Tutti i comandi "Filo Pilota" sono disattivati.

Quando sul display è visualizzata l'icona , la resistenza è attiva.

4.2.1 FILO PILOTA

Per attivare il modo "Filo Pilota":





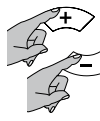



Premere il tasto "Modo" finché l'icona  non appare sul display.



L'utente può regolare solo la temperatura di "Comfort" dall'apparecchio.

Selezionare la temperatura desiderata utilizzando i tasti "+" e "-".

L'abitazione deve essere provvista di un sistema di gestione che supporti questo tipo di tecnologia. In questo caso, per verificare la trasmissione corretta degli ordini di programmazione, è possibile utilizzare lo schema seguente, in base al modo impostato:

Modo	Comfort	Notte/Eco (Comfort -3,5 °C)	Anti-Gelo	Standby	Comfort -1 °C	Comfort -2 °C
Segnale da trasmettere						
Tensione tra il Filo Pilota e neutro	0 volt	230 volt	115 volt negativo	115 volt positivo	230 volt per un intervallo di 3 s	230 volt per un intervallo di 7 s

L'icona del modo selezionato dalla centralina (Standby, Comfort, Notte/Eco, Anti-Gelo) compare sul display in aggiunta all'icona .

Se il Filo Pilota non è collegato, viene automaticamente selezionato il modo "Comfort".

4.2.2 COMFORT ✱

La temperatura di "Comfort" corrisponde alla temperatura desiderata dall'utilizzatore.



Premere il tasto "Modo" finché l'icona ✱ non appare sul display.



Selezionare la temperatura desiderata utilizzando i tasti "+" e "-".



L'intervallo di regolazione della temperatura va da 7 °C a 32 °C.

4.2.3 NOTTE/ECO

In modo "Notte/Eco" la temperatura impostata deve essere uguale o inferiore alla temperatura di "Comfort". Se si cerca di impostare una temperatura di "Comfort" inferiore a "Notte/Eco", quest'ultima temperatura verrà variata di conseguenza.



Premere il tasto "Modo" finché l'icona  non appare sul display.



Selezionare la temperatura desiderata utilizzando i tasti "+" e "-".



Questo modo è raccomandato nelle ore notturne e quando la stanza rimane vuota per 2 ore o più.

4.2.4 ANTI-GELO ✱

Nel modo "Anti-Gelo" la temperatura è fissata a 7 °C. L'apparecchio si avvia automaticamente per temperature ambiente inferiori ai 7 °C e con un minimo consumo di energia impedisce al locale di raggiungere temperature di congelamento.



Premere il tasto "Modo" finché l'icona ✱ non appare sul display.

Questo modo è raccomandato quando la stanza rimane vuota per un giorno o più.

4.2.5 CRONO

Il modo "Crono" permette all'utente di selezionare uno dei tre programmi di cronotermostatazione preimpostati, oppure il programma personalizzabile. Quest'ultimo consente di impostare diverse temperature ("Comfort" e "Notte/Eco") nell'arco delle 24 ore, per ogni giorno della settimana.

SCELTA DEL PROGRAMMA



Premere il tasto "Modo" finché l'icona  non appare sul display. Quindi premere contemporaneamente i tasti "Modo" e "-", mantenendoli entrambi premuti per almeno 3 secondi.

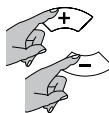

Il numero che indica il programma (P1, P2, P3 e P4) lampeggia: premere i pulsanti "+" e "-" per impostare il programma desiderato. Premere il pulsante "Modo" per confermare.

A questo punto lampeggia l'icona della funzione ASC (vedi cap 4.3.1), premere il tasto  per attivare la funzione o il tasto "-" per disattivarla.

PROGRAMMA P1	ORE	MODO
DAL LUNEDÌ AL VENERDÌ	0 - 6	Notte/Eco
	6 - 9	Comfort
	9 - 16	Notte/Eco
	16 - 23	Comfort
	23 - 0	Notte/Eco
SABATO E DOMENICA	0 - 7	Notte/Eco
	7 - 23	Comfort
	23 - 0	Notte/Eco

PROGRAMMA P2	ORE	MODO
DAL LUNEDÌ A DOMENICA	0 - 7	Notte/Eco
	7 - 23	Comfort
	23 - 0	Notte/Eco

PROGRAMMA P3	ORE	MODO
DAL LUNEDÌ AL VENERDÌ	0 - 6	Notte/Eco
	6 - 9	Comfort
	9 - 13	Notte/Eco
	13 - 23	Comfort
	23 - 0	Notte/Eco
SABATO E DOMENICA	0 - 7	Notte/Eco
	7 - 23	Comfort
	23 - 0	Notte/Eco

PROGRAMMA P4 - PERSONALIZZATO

Il programma "P4" permette all'utente di impostare diverse temperature ("Comfort" e "Notte/Eco") nell'arco delle 24 ore, per ogni giorno della settimana.

REGOLAZIONE DELLA DATA E DELL'ORA

Prima di procedere con l'impostazione del programma personalizzabile P4 verificare che l'ora e il giorno della settimana siano corretti.



Se così non fosse, premere il tasto "Modo" finché l'icona  non appare sul display. Quindi premere nuovamente il tasto "Modo" mantenendolo premuto fino a quando il numero che indica il giorno lampeggia.

1
2
3
4

Premere i tasti "+" e "-" per impostare il giorno della settimana corretto (1=LUN, 2=MAR,... 7=DOM). Premere il tasto "Modo" per confermare.

20:30

Ripetere la stessa procedura per regolare le ore.

20:30

A questo punto lampeggiano i minuti, utilizzare i tasti "+" e "-" per impostarli e premere il tasto  per confermare e uscire o il tasto "Modo" per entrare nell'impostazione del programma P4.

IMPOSTAZIONE DEL PROGRAMMA P4

Per entrare nell'impostazione del programma personalizzato P4 premere il tasto "MODO" al termine della regolazione dei minuti (vedi REGOLAZIONE DELL'ORA).

Partendo dal primo giorno selezionare la sequenza oraria desiderata utilizzando i pulsanti "+" e "-" scegliendo, per ogni ora, tra la temperatura "Comfort" (doppia tacca) e la temperatura "Notte/Eco" (tacca singola).

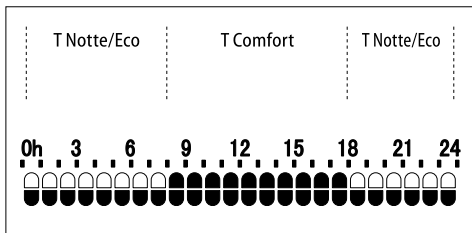

Premere il tasto "Modo" per confermare e ripetere la medesima procedura per ogni giorno della settimana. La programmazione settimanale è ora impostata.

A questo punto lampeggia l'icona della funzione ASC (vedi cap 4.3.1), premere il tasto  per attivare la funzione o il tasto "-" per disattivarla.

4.2.6 ENERGY SAVING

In questo modo la temperatura è fissata a 17 °C. L' "Energy Saving" consente di ridurre i consumi nel caso in cui la stanza venga lasciata vuota ma si voglia mantenere una temperatura confortevole.



Per attivare l' "Energy Saving" premere il tasto "Modo" finché la scritta "E S" non appare sul display in sostituzione dell'ora/temperatura.

4.3 FUNZIONI

L'apparecchio è dotato di funzioni speciali che consentono di personalizzare ed ottimizzare l'utilizzo dell'apparecchio.

4.3.1 ASC

Questa funzione rileva l'inerzia della stanza per raggiungere la temperatura impostata e anticipa l'accensione del radiatore per assicurare che la temperatura "Comfort" venga ottenuta all'ora impostata.

L'accensione dell'apparecchio può essere anticipata dalla funzione al massimo di 2 ore.



Questa funzione è attivabile ed operativa solo nel modo "Crono". (vedi Cap. 4.2.5)





Per l'ottimale funzionamento dell'ASC occorrono alcuni giorni di acquisizione dati.

4.3.2 FINESTRA APERTA

La funzione "Finestra Aperta" permette all'apparecchio di rilevare autonomamente l'eventuale apertura di una finestra in prossimità del radiatore (ad esempio durante le pulizie di casa) e di porsi in modo "Anti-Gelo", al fine di prevenire un riscaldamento inutile ed evitare sprechi di energia. Allo stesso modo è in grado di rilevare la chiusura della finestra e di ripristinare la condizione operativa precedentemente impostata.

All'accensione dell'apparecchio la funzione è già attiva, in attesa di rilevare un'eventuale apertura della finestra.



Per attivare o disattivare la funzione premere il tasto  e mantenerlo premuto fino a quando l'icona  appare o scompare dal display.



Quando viene rilevata l'apertura di una finestra l'icona "Finestra Aperta" lampeggia.

In questo momento premendo il tasto  è possibile annullare l'azione della "Finestra Aperta" fino al rilevamento di una successiva apertura.

L'icona  smette di lampeggiare.

Per garantire l'azione ottimale della funzione è consigliato installare l'apparecchio in corrispondenza di una finestra (Fig. 9).

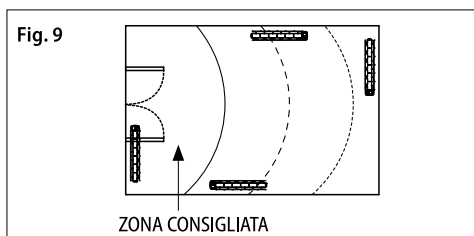

La risposta dell'apparecchio alle aperture e alle chiusure della finestra dipende da molteplici fattori, tra cui temperatura impostata sull'apparecchio, temperatura esterna, grado di ventilazione del locale in cui è installato il radiatore, posizione del radiatore all'interno della stanza, presenza di altre fonti di calore.



La funzione "Finestra Aperta" non è attivabile o disattivabile in modo "Standby".



Se l'apparecchio ha rilevato l'apertura di una finestra, tutti i modi e la funzione "Marcia Forzata (2h)" sono selezionabili ma non attivi fino al rilevamento della chiusura della finestra o all'annullamento della funzione "Finestra Aperta". Le funzioni "Sicurezza Bambini" e "Blocco Tastiera" rimangono attive e sono attivabili o disattivabili anche quando l'apparecchio ha rilevato l'apertura di una finestra.

4.3.3 SICUREZZA BAMBINI

Attivando la funzione "Sicurezza Bambini" la temperatura superficiale dell'apparecchio viene ridotta rispetto al normale funzionamento del modo attivo ("Comfort", "Notte/Eco",...) in modo da diminuire il rischio di scottature in caso di contatto breve ed accidentale.

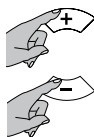

Per attivare la funzione premere contemporaneamente i tasti "+" e "-", mantenendoli entrambi premuti finché l'icona  non appare sul display.

Per disattivare la funzione ripetere la stessa operazione.

La "Sicurezza Bambini" è attivabile in ogni modo operativo e anche nella funzione "Marcia Forzata (2h)". La funzione non è attivabile se l'apparecchio si trova in "Standby".

NOTE IMPORTANTI:

In questa funzione l'energia termica rilasciata dall'apparecchio viene ridotta e quindi è necessario un tempo più lungo per riscaldare gli ambienti.

Anche utilizzando questa funzione i bambini devono essere sorvegliati per sincerarsi che non si mettano in condizioni di pericolo.



Va comunque evitato qualsiasi contatto prolungato tra parti del corpo e l'apparecchio.

Se l'apparecchio è già in funzione o è ancora caldo per un utilizzo recente e si attiva la "Sicurezza Bambini", occorrono almeno due ore perché la temperatura scenda al valore ridotto e quindi la funzione sia operativa.

4.3.4 MARCIA FORZATA (2H)

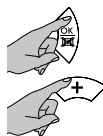
Attivare la funzione "Marcia Forzata (2h)" per riscaldare la stanza più velocemente.



Per attivare la funzione premere contemporaneamente i tasti  e "+", mantenendoli entrambi premuti finché il simbolo  non appare sul display.

I minuti mancanti al termine delle due ore vengono visualizzati sul display in sostituzione dell'ora.

L'apparecchio scalda per due ore alla massima potenza ignorando la precedente impostazione di temperatura.

Per disattivare la funzione "Marcia Forzata (2h)" premere contemporaneamente i due tasti come fatto in precedenza.

Dopo due ore dall'attivazione la funzione "Marcia Forzata (2h)" si disattiva comunque automaticamente e l'apparecchio ritorna nel modo operativo precedentemente selezionato.





La funzione "Sicurezza Bambini" limita la potenza del radiatore anche nella funzione "Marcia Forzata (2h)".



Se l'apparecchio ha rilevato l'apertura di una finestra, la funzione "Marcia Forzata (2h)" non è attiva fino al rilevamento della chiusura della finestra o all'annullamento della funzione "Finestra Aperta" (vedi Cap. 4.3.2), mentre il conto alla rovescia al termine delle due ore prosegue.

4.3.5 VACANZA

Nel caso ci si assenti da casa per un numero prestabilito di giorni, è possibile impostare il radiatore in modo che si mantenga in modo "Anti-Gelo" durante tutto il periodo di assenza e si riattivi automaticamente nel modo precedentemente selezionato allo scadere dei giorni impostati.

Per attivare la funzione premere contemporaneamente i tasti  e “-”, mantenendoli entrambi premuti finché l'icona  non appare sul display.

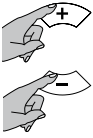

Utilizzare i tasti “+” e “-” per impostare il numero di giorni (massimo 45 giorni). L'impostazione desiderata si autoconferma.

A questo punto il display visualizza l'icona  e il numero di giorni impostato, che decresce progressivamente con il trascorrere dei giorni.



Per disattivare in qualsiasi momento la funzione premere contemporaneamente i tasti  e “-”.

4.3.6 BLOCCO TASTIERA

È possibile bloccare la tastiera del comando per evitare modifiche accidentali.

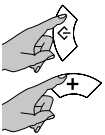

Per attivare la funzione premere contemporaneamente i tasti “Modo” e “+”, mantenendoli entrambi premuti finché l'icona  non appare sul display.

Per sbloccare la tastiera, premere contemporaneamente i due tasti come fatto in precedenza.

L'icona “Blocco tastiera” non sarà più visualizzata sul display.

IMPORTANTE: La funzione “Blocco Tastiera” non inibisce il tasto “Standby” che, quindi, è sempre operativo anche quando la funzione “Blocco Tastiera” è attiva.

4.4 INDICATORE COMPORTAMENTALE

L'indicatore comportamentale vi permette di verificare se la temperatura che avete impostato è in linea con quelle raccomandate al fine di evitare sprechi e ridurre i consumi energetici.

Una freccia si posizionerà in corrispondenza di una delle tre barre colorate che rappresentano qualitativamente il consumo energetico secondo il seguente schema:

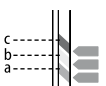

(a) **Verde:** La temperatura scelta è già inferiore a quella raccomandata.

(b) **Giallo:** La temperatura è adeguata, ma è consigliato ridurla leggermente.

(c) **Rosso:** La temperatura scelta è elevata, sarebbe opportuno ridurla.

ATTENZIONE: L'indicatore fornisce una indicazione esclusivamente qualitativa del consumo energetico, non una misura assoluta.

4.5 INDICATORE DELLA POTENZA Istantanea

Questo grafico fornisce un'immediata rappresentazione dell'utilizzo della potenza del radiatore (ogni settore rappresenta il 20% della potenza).

IMPORTANTE: In caso di mancanza di alimentazione tutte le impostazioni correnti vengono mantenute perdendo però l'impostazione di data e ora.

Se la mancanza di alimentazione si verifica in modo “Crono”, al ripristino il radiatore si riattiva in modo “Energy Saving”.

IMPORTANTE: In caso di mancanza di alimentazione mentre la funzione “Marcia Forzata (2h)” è attiva, al ripristino dell'alimentazione l'impostazione di data e ora viene persa e l'apparecchio esce dalla funzione ponendosi nel modo operativo precedentemente selezionato.

IMPORTANTE: In caso di mancanza di alimentazione mentre la funzione “Vacanza” è attiva al ripristino dell'alimentazione la funzione rimane attiva e riprende il conto alla rovescia dei giorni mancanti al momento dell'interruzione.

IMPORTANTE: In caso di mancanza di alimentazione mentre la funzione “ASC” è attiva al ripristino dell'alimentazione la funzione è attiva e necessita di qualche giorno per ritornare pienamente operativa.

5. PULIZIA



Prima di ogni operazione di pulizia assicurarsi che l'apparecchio sia spento, freddo e scollegato elettricamente.



Per la pulizia è sufficiente utilizzare un panno umido e morbido con un detergente neutro. Non usare detergenti abrasivi, corrosivi o solventi.



Per mantenere l'efficienza dell'apparecchio rimuovere la polvere dalla superficie e dall'interno dell'apparecchio almeno due volte all'anno utilizzando un aspirapolvere.

6. MANUTENZIONE



In caso di problemi tecnici rivolgersi a personale qualificato (riconosciuto e autorizzato dal rivenditore o dal fabbricante) o contattare il proprio rivenditore.



Qualsiasi tipo di intervento sull'apparecchio deve essere effettuato da personale qualificato che, prima di ogni operazione di manutenzione, deve assicurarsi che l'apparecchio sia spento, freddo e scollegato elettricamente.

7. PROBLEMI E SOLUZIONI

L'apparecchio non scalda.	<ul style="list-style-type: none"> • Controllare che ci sia alimentazione elettrica e che l'apparecchio sia collegato nel modo esatto. • Verificare la posizione dell'interruttore generale. • Aumentare la temperatura impostata sul regolatore di temperatura dell'apparecchio. • Per il tipo di resistenza presente, l'apparecchio diventa caldo dopo alcune decine di minuti. Aspettare il tempo necessario. • È intervenuto il dispositivo di sicurezza. Eliminare la causa del surriscaldamento (ad esempio ostruzioni, coperture)  • Scollegare elettricamente per qualche minuto l'apparecchio in modo da resettare il sistema elettronico. • Se non scalda ancora, contattare il rivenditore o personale qualificato.
L'apparecchio scalda in continuazione.	<ul style="list-style-type: none"> • Diminuire la temperatura impostata sul regolatore di temperatura dell'apparecchio. • Verificare di non aver attivato accidentalmente la funzione "Marcia Forzata (2h)". • Se scalda ancora, contattare il rivenditore o personale qualificato.
La stanza rimane fredda.	<ul style="list-style-type: none"> • Verificare che la potenza dell'apparecchio sia adeguata al fabbisogno della stanza da riscaldare. • Nel caso di prima accensione, la stanza impiega alcune ore per raggiungere la temperatura desiderata (mettere la regolazione al massimo non fa aumentare la temperatura più in fretta).
L'apparecchio non si raffredda.	<ul style="list-style-type: none"> • Per il tipo di resistenza presente, l'apparecchio diventa freddo dopo alcune decine di minuti. Aspettare il tempo necessario.
Perdite di liquido contenuto nell'apparecchio.	<ul style="list-style-type: none"> • Spegner l'apparecchio e contattare il rivenditore. • Asciugare le perdite utilizzando guanti di protezione dai prodotti chimici. Tener lontano i bambini e gli animali domestici dal liquido.
L'apparecchio non risponde correttamente agli ordini derivanti dalla centralina Filo Pilota.	<ul style="list-style-type: none"> • Scollegare elettricamente l'apparecchio (posizionare l'interruttore generale dell'impianto in posizione "0"). Assicurarsi che il collegamento sia fatto come prescritto in queste istruzioni (Fig.8) e che la centralina funzioni correttamente. • Contattare personale qualificato.
L'apparecchio continua a scaldare nonostante la finestra sia aperta mentre la funzione "Finestra Aperta" è attiva.	<ul style="list-style-type: none"> • Può essere necessario attendere qualche minuto prima che la funzione diventi operativa. • Può essere che la differenza tra temperatura esterna ed interna non sia sufficiente a rendere la funzione operativa. • Verificare che il posizionamento dell'apparecchio sia conforme alle prescrizioni riportate nel capitolo 4.3.2 del presente libretto. • Verificare che lo spazio circostante il fianco di comando del radiatore sia sgombro di eventuali ostacoli. • Se il problema persiste contattare il rivenditore o personale qualificato.
L'apparecchio non riprende a scaldare dopo la chiusura della finestra mentre la funzione "Finestra Aperta" è attiva.	<ul style="list-style-type: none"> • Può essere necessario attendere qualche minuto prima che il sensore rilevi la chiusura della finestra. • Verificare che lo spazio circostante il fianco di comando del radiatore sia sgombro di eventuali ostacoli. • Disattivare e riattivare la funzione. • Se il tempo di risposta della funzione dovesse rivelarsi eccessivo, potete comunque riavviare manualmente il radiatore. • Se il problema persiste contattare il rivenditore o personale qualificato.
Sul display appare il messaggio "ALL".	<ul style="list-style-type: none"> • La sonda di temperatura è danneggiata. Spegner l'apparecchio e contattare il vostro rivenditore.

8. GARANZIA



Si raccomanda di conservare l'imballo, in tutte le sue parti per l'eventuale restituzione dell'apparecchio al proprio rivenditore, l'apparecchio deve pervenire integro al fine del mantenimento delle condizioni di garanzia.

Il costruttore garantisce ai suoi clienti tutti i diritti specificati nella direttiva europea 1999/44/CE e i diritti dei consumatori riconosciuti dalle legislazioni nazionali.

La garanzia copre specificamente ogni non-conformità e difetto di produzione presente sul prodotto al momento della vendita e che si evidenzia entro due anni dalla data di acquisto e dà diritto al cliente di ottenere la riparazione gratuita del prodotto difettoso o la sostituzione nel caso non sia riparabile.

I diritti summenzionati vengono a cadere nei seguenti casi:

- difetti causati da usi diversi rispetto a quelli specificati nel presente libretto, che costituisce parte integrante del contratto di vendita;
- difetti causati da rottura accidentale, negligenza o manomissioni.

Non sono da intendersi come prestazioni in garanzia gli interventi inerenti l'installazione, l'allacciamento agli impianti di alimentazione e le manutenzioni citate nel libretto delle istruzioni.

Il Costruttore declina ogni responsabilità per danni o ferite provocati direttamente o indirettamente a persone, oggetti o animali domestici come risultato della mancata applicazione delle prescrizioni riportate nel presente libretto, con particolare riferimento alle avvertenze riguardanti l'installazione la messa in servizio del prodotto e utilizzo.

Per godere dei diritti di cui sopra, il Cliente deve contattare il proprio rivenditore ed esibire una valida prova d'acquisto rilasciata dal venditore, completa della data d'acquisto del prodotto.

9. SMALTIMENTO



Assicurarsi che il cavo di alimentazione sia scollegato dalla linea elettrica prima di qualsiasi operazione. Per lo smontaggio seguire al contrario le fasi di fissaggio a parete (Schema 1).

Per la rottamazione dell'apparecchio seguire la normativa vigente per lo smaltimento e la gestione dei rifiuti.



Avvertenze per il corretto smaltimento del prodotto ai sensi della Direttiva Europea 2012/19/EC.

Alla fine della sua vita utile il prodotto non deve essere smaltito insieme ai rifiuti urbani.

Può essere consegnato presso gli appositi centri di raccolta differenziata predisposti dalle amministrazioni comunali, oppure presso i rivenditori che forniscono questo servizio.



Questo apparecchio è conforme alle Direttive europee:
 2014/30/EU sulla compatibilità elettromagnetica
 2014/35/EU sulla bassa tensione
 2011/65/EU sulla restrizione dell'uso di sostanze pericolose



COLLEGAMENTO ELETTRICO CON SPINA LEGGERE CON ATTENZIONE

Prima di inserire la spina nella presa di corrente verificare attentamente che la tensione della vostra rete domestica corrisponda al valore in V indicato sulla targa caratteristiche dell'apparecchio e che la presa di corrente e la linea di alimentazione siano correttamente dimensionate rispetto alla potenza del dispositivo (anch'essa indicata sulla targa caratteristiche).

Assicurarsi che la linea di alimentazione sia dotata di un dispositivo che permetta il sezionamento dell'apparecchio dalla rete domestica, secondo la normativa vigente.

È obbligatorio che la linea elettrica sia dotata di un dispositivo di protezione differenziale ad alta sensibilità con corrente nominale differenziale di intervento non superiore a 30 mA.

Tutti i riferimenti presenti nel libretto relativi all'utilizzo del modo "Filo Pilota" (Fil Pilote) e alle relative connessioni sono da ignorare in quanto l'apparecchio è sprovvisto di questo modo di funzionamento.

QUESTO APPARECCHIO È CONFORME ANCHE ALLA DIRETTIVA EUROPEA 2009/125/CE
E AL RELATIVO REGOLAMENTO (UE) 2015/1188.

Informazioni obbligatorie per gli apparecchi per il riscaldamento d'ambiente locale elettrici.

Identificativo del modello: (vedi etichetta caratteristiche sul prodotto)

Contatti:

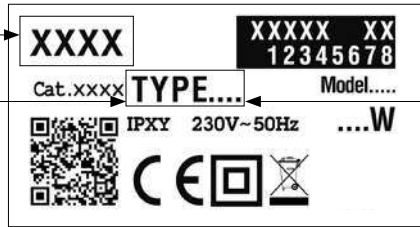

POTENZA TERMICA	TYPE	VALORE	UNITÀ
Potenza termica nominale (P_{nom})	xVExx07x	0,7	kW
	xVExx09x	0,9	
	xVExx10x	1,0	
	xVExx12x	1,2	
	xVExx15x	1,5	
	xVExx18x	1,8	
	xVExx20x	2,0	
Potenza termica minima (indicativa) (P_{min})	xVExx07x	0,0	kW
	xVExx09x		
	xVExx10x		
	xVExx12x		
	xVExx15x		
	xVExx18x		
	xVExx20x		
Massima potenza termica continua ($P_{max,c}$)	xVExx07x	0,7	kW
	xVExx09x	0,9	
	xVExx10x	1,0	
	xVExx12x	1,2	
	xVExx15x	1,5	
	xVExx18x	1,8	
	xVExx20x	2,0	

CONSUMO AUSILIARIO DI ELETTRICITÀ	TYPE	VALORE	UNITÀ
Alla potenza termica nominale (e_{max})	xVExx07x	0,000	kW
	xVExx09x		
	xVExx10x		
	xVExx12x		
	xVExx15x		
	xVExx18x		
	xVExx20x		
Alla potenza termica minima (e_{min})	xVExx07x	0,000	kW
	xVExx09x		
	xVExx10x		
	xVExx12x		
	xVExx15x		
	xVExx18x		
	xVExx20x		
In modo standby (e_{sb})	xVExx07x	0,000	kW
	xVExx09x		
	xVExx10x		
	xVExx12x		
	xVExx15x		
	xVExx18x		
	xVExx20x		

Tipo di potenza termica/controllo della temperatura ambiente

- potenza termica a fase unica senza controllo della temperatura ambiente [NO]
- due o più fasi manuali senza controllo della temperatura ambiente [NO]
- con controllo della temperatura ambiente tramite termostato meccanico [NO]
- con controllo elettronico della temperatura ambiente [NO]
- con controllo elettronico della temperatura ambiente e temporizzatore giornaliero [NO]
- con controllo elettronico della temperatura ambiente e temporizzatore settimanale [SI]

Altre opzioni di controllo

- controllo della temperatura ambiente con rilevamento di presenza [NO]
- controllo della temperatura ambiente con rilevamento di finestre aperte [SI]
- con opzione di controllo a distanza [NO]
- con controllo di avviamento adattabile [SI]
- con limitazione del tempo di funzionamento [NO]
- con termometro a globo nero [NO]

SYMBOLS USED IN THE MANUAL



IMPORTANT!
DANGER FOR THE SAFETY OF PERSONS, PETS AND THINGS.



IMPORTANT!
DANGER OF ELECTRIC SHOCK.



IMPORTANT!
DANGER OF DAMAGE TO THE APPLIANCE.



IMPORTANT!
HIGH TEMPERATURES. RISK OF BURNS.



TIPS FOR EFFICIENT OPERATION.



DO NOT COVER THE APPLIANCE!

GB

WARNING



CAUTION: Some parts of this product can become very hot and cause burns. Particular attention has to be given where children and vulnerable people are present.



Children of less than 3 years should be kept away unless continuously supervised.

Children aged from 3 years and less than 8 years shall only switch on/off the appliance provided that it has been placed or installed in its intended normal operating position and they have been given supervision or instruction concerning use of the appliance in a safe way and understand the hazards involved.

Children between 3 and 8 years old must not disconnect, regulate and clean the appliance or perform user maintenance.

This appliance can be used by children aged from 8 years and above and persons with reduced physical, sensory or mental capabilities or lack of experience and knowledge if they have been given supervision or instruction concerning use of the appliance in a safe way and understand the hazards involved. Children shall not play with the appliance. Cleaning and user maintenance shall not be made by children without supervision.



Never install the appliance:

- immediately below or in front of a power socket or a junction box (Fig. 5)
- in contact with the wall or floor
- near curtains, flammable or combustible materials or pressure vessels.



WARNING:

Respect the distances shown in figures 3,4.



Install and use the appliance as described in these instructions only.



If the supply cord is damaged, it must be replaced by the manufacturer, its service agent or similarly qualified persons in order to avoid hazard. Never use the appliance if the electronic controls are damaged.



Make sure the fixed power line is fitted with a disconnecting switch allowing the appliance to be disconnected completely from the household mains, included the Pilot Wire, when present, in accordance with the wiring rules.



WARNING: to avoid hazardous overheating, never under any circumstances cover the appliance (Fig.7). Never obstruct the air flow by inserting material into the appliance.



To dispose of the appliance, comply with current legislation for the disposal and management of waste.

1. SPECIFICATIONS OF THE APPLIANCE

Voltage: 230 V ~ 50 Hz

Insulation class: II 

Protection class: IPx4

TYPE	Power [W]	Length [cm]	Height [cm]	Weight [kg]	Rated current [A]
CVE0610F	1000	55	58	16	4,5
CVE0915F	1500	79	58	24	6,5
CVE1220F	2000	104	58	32	9
DVE0610F	1000	55	58	11	4,5
DVE0915F	1500	79	58	16	6,5
DVE1118F	1800	95	58	19	8
EVE0610F	1000	55	58	17	4,5
EVE0915F	1500	79	58	25	6,5
EVE1220F	2000	103	58	33	9

Table 1

 The technical specifications of the appliance are indicated on the rating plate on the side of the radiator (Fig. 1).

A Brand/Manufacturer	F Double isolation
B Model, type, category	G Disposal procedures
C Bidimensional Code (QR)	H Quality marks
D Protection class	I Voltage and Power
E CE marking	L Serial number

2. GENERAL INFORMATION



Unpack the appliance carefully and rest it on the polystyrene corner pieces or a carpet.

The package contains:

- the appliance
- mounting kit
- instructions



Read all the instructions carefully before installation and use. Keep for future consultation.



Install and use the appliance as described in these instructions only.



These instructions do not cover all situations which might arise. Caution and common sense should be applied when installing, operating and servicing the appliance.



Modifying the characteristics of the appliance and removing any fixed component including the caps is expressly prohibited. Make sure the appliance is complete and undamaged. If damaged, do not use the appliance, but contact your local dealer or a qualified professional.



The materials used for packaging can be recycled. You are therefore recommended to dispose of them in special differentiated waste collection containers.

3. POSITIONING AND INSTALLING



The appliance is designed to heat domestic rooms or similar. It must not be used for other purposes. The appliance must be used permanently mounted on a wall as described in the instructions. Install the appliance with the thermostat at the bottom (Fig. 2).



In bathrooms (with bath or shower), install the appliance outside zone 1.

The appliance must be installed in such a way that the electronic controls and other control devices may not be touched by someone in the bath or shower. The appliance must not be connected with a plug.



For radiators already fitted with power plugs, see the warnings on page 23.



Respect the distances shown in figures 3,4.



Never install the appliance:

- immediately below or in front of a power socket or a junction box (Fig. 5)
- in contact with the wall or floor
- near curtains, flammable or combustible materials or pressure vessels.



Make sure there are no pipes or electric wires in the wall which could be damaged while mounting the appliance.



The appliance is equipped with a sensor which can detect an open window, if present above the radiator or within the room. For a proper operation, it is strongly recommended to comply to the installation directions reported in Ch. 4.3.2 before wall mounting.

3.1 WALL MOUNTING



Make sure the screws and anchors included in the mounting pack are suitable for the type of wall on which you are mounting the appliance. If in doubt, contact a qualified professional or your local dealer.



Follow the installation sequence shown on the folding leaf of the cover (Scheme 1), respecting the minimum distance between the bottom of the radiator and the floor (Fig. 3).



During installation, make sure the power cable is disconnected from the power line.

3.2 ELECTRICAL CONNECTIONS



WARNING

To be installed by a specialised engineer in accordance with the applicable standards in the country concerned.

When the appliance is installed, make sure the power is off and the mains switch is in the "O" position.



The appliance requires a 230 V ~ 50 Hz power supply. Make sure the power line is appropriate for the data given in table 1.



Make sure the fixed power line is fitted with a disconnecting switch allowing the appliance to be disconnected completely from the household mains, included the Pilot Wire, when present, in accordance with the wiring rules.

If the appliance is installed in a bathroom, the power line must be fitted with a 30 mA RCD (high sensitivity residual current protection device).

The power supply line and Pilot Wire control unit must be protected by the same RCD.

Permanently connected appliances must be connected using a connector block placed within a proper junction box.

When installing the appliance in damp rooms (kitchen, bathroom), the point of connection with the household mains must be at least 25 cm from the floor.

Respect the wiring diagram in figure 8 scrupulously.



If the Pilot Wire is not connected to the programming unit, it must be terminated and insulated. Under no circumstances should the Pilot Wire be connected to the earth.



Make sure the power cable cannot in any way come into contact with the surface of the appliance (Fig. 6).

4. REGULATION AND OPERATION



The appliance is designed to heat rooms. Some parts of this product can become very hot and cause burns. Particular attention has to be given where children and vulnerable people are present.



GB



Keep combustible or flammable materials or pressure vessels (e.g. spray cans, fire extinguishers) at least 50 cm from the appliance. Do not vaporise any type of substance on the surface of the appliance.



Never touch the appliance with wet or damp hands or feet. Do not wet the electronic control unit with water or other fluids. If this occurs, disconnect the appliance from the mains power supply and allow to dry completely.



When the appliance is installed at high altitude, the air will be hotter than the set temperature.



When you turn the appliance on for the first time, it is normal for it to give off a smell which disappears rapidly. You are recommend to ventilate the room after using the appliance for the first time.



In cold conditions, the radiator may emit metallic sounds when turned on. This is due to the expansion of the materials.



Possible traces of oil noted on the bottom of the radiator during mounting or the first times you turn the appliance on may be left from the fabrication process. Clean the part with proper precautions at intervals of a couple of days. If the problem reoccurs, follow the instructions in Chapter 7.

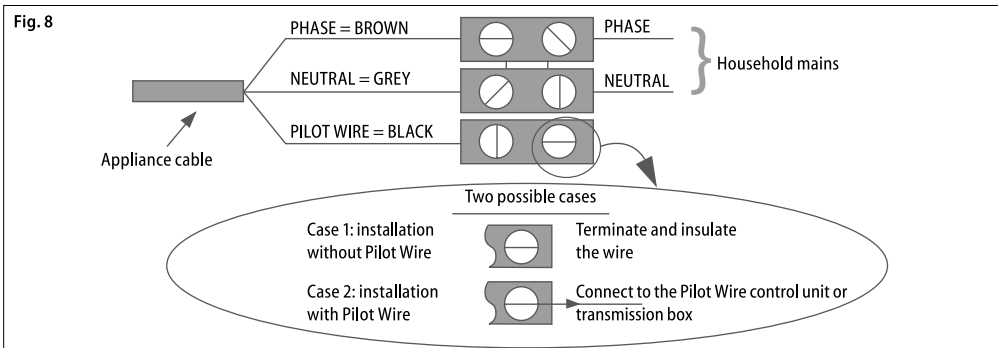

USING THE RADIATOR FROM THE CONTROL PANEL:

GB

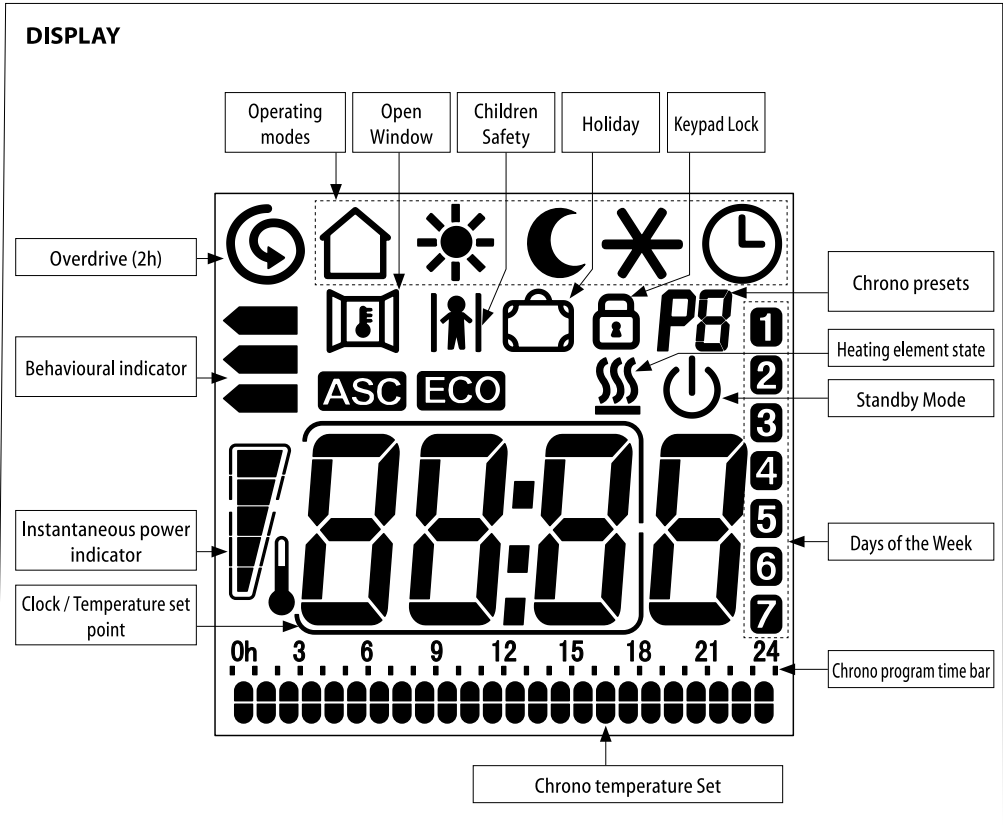
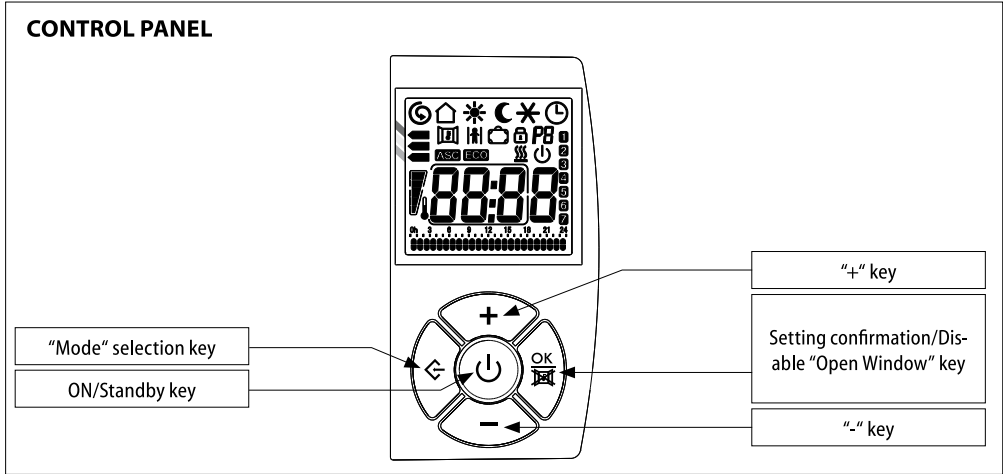

4.1 ON/STANDBY MODE



In "Standby" mode the LCD displays the Standby icon , the hour and day of the week. All the operating modes are suspended ("Pilot Wire" included), but the appliance is powered and waiting for command reception.



To turn on or off the appliance, press the "Standby" key. The radiator turns on in the previously selected operating mode and emits a sound.

In "Chrono" mode the display shows the time, in the other modes the temperature setting is displayed.







The entry into "Standby" mode is signalled by means of a double beep, the exit from "Standby" mode by means of a long beep.

4.2 OPERATING MODES

The appliance provides 6 operating modes which allow the user to heat the environment in the most suitable way with respect to his needs.



Press the "Mode" selection key to select the desired operating mode. An icon on the LCD will show the selected operating mode.

	Pilot Wire		Comfort
	Night/Eco		Anti-Freeze
	Chrono		Energy Saving



PILOT WIRE

The temperature depends on the "Pilot Wire" command. All "Pilot Wire" commands are enabled.



COMFORT

The "Comfort" temperature corresponds to the temperature desired by the user. All "Pilot Wire" commands are disabled.



NIGHT/ECO

The "Night/Eco" mode keeps a comfortable temperature with a reduced energy consumption. All "Pilot Wire" commands are disabled.



ANTI-FREEZE

In "Anti-Freeze" mode, the temperature set point is fixed at 7 °C. The appliance starts heating automatically when the room temperature drops below 7 °C. All "Pilot Wire" commands are disabled.



CHRONO

In this mode, you can select one of the three pre-set chrono-thermostat programs or the custom program. The latter lets you set a daily and weekly program with two temperature levels ("Comfort" and "Night/Eco"). All "Pilot Wire" commands are disabled.



ENERGY SAVING

This mode reduces the appliance's energy consumption when the room is left unoccupied. Temperature is fixed at 17 °C. All "Pilot Wire" commands are disabled.

When the icon  is displayed on the LCD, the heating element is on.

4.2.1 PILOT WIRE

To activate the "Pilot Wire" mode:







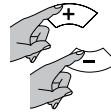

Press the "Mode" selection key until the icon  appears on the LCD.

Users can only set the "Comfort" temperature on the appliance.



Select the desired temperature set point by using the "+" and "-" keys.

The home must be fitted with an automation system supporting this type of technology. In this case, correct transmission of the programming commands can be verified using the following diagram according to the mode set:

Mode	Comfort	Night/Eco (Comfort -3,5 °C)	Anti-Freeze	Standby	Comfort -1 °C	Comfort -2 °C
Signal to be transmitted						
Voltage between Pilot Wire and neutral wires	0 volt	230 volt	115 volt Negative	115 volt Positive	230 volt For an interval of 3 s	230 volt For an interval of 7 s

The icon showing the mode selected on the control unit (Standby, Comfort, Night/Eco, Anti-Freeze) is displayed together with the  icon.

If the Pilot Wire programmer is not connected, "Comfort" operating mode is selected automatically.

4.2.2 COMFORT ✱

The "Comfort" temperature set point is the temperature desired by the user.



Press the "Mode" selection key until the icon ✱ appears on the LCD.

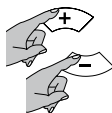

Select the desired temperature set point by using the "+" and "-" keys. The temperature can be chosen in the interval between 7 °C and 32 °C.

4.2.3 NIGHT/ECO

In "Night/Eco" mode the temperature set point must not be higher than "Comfort" temperature set point. If the "Comfort" temperature is set below the "Night/Eco" temperature, the latter will be automatically adjusted accordingly.



Press the "Mode" selection key until the icon  appears on the LCD.

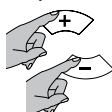

Select the desired temperature set point by using the "+" and "-" keys.

The use of this operating mode is recommended in night-time hours and in case no people is in the room for more than 2 hours.

4.2.4 ANTI-FREEZE ✱

In "Anti-Freeze" mode the temperature set point is fixed at 7 °C. The appliance starts heating when room temperature goes under 7 °C and with low energy consumption it prevents the room temperature to reach the freezing point.



Press the "Mode" selection key until the icon ✱ appears on the LCD.

This operating mode is recommended when no people is in the room for more than 1 day.

4.2.5 CHRONO

In "Chrono" mode, you can select one of the three preset chrono-thermostat programs or the custom program. The latter lets you set various temperatures ("Comfort" and "Night/Eco") over a 24 hour period for each day of the week.

CHOICE OF PROGRAM



Press the "Mode" key until the icon  is displayed. Then press the "Mode" and "-" keys together and hold them both down for at least 3 seconds.

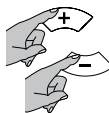

The program code (P1, P2, P3 and P4) flashes. Press the "+" and "-" keys to set the program. Press the "Mode" key to confirm.

The icon of the ASC function (see Ch. 4.3.1) starts flashing. Press the  key to activate the function or the "-" key to de-activate it.

PROGRAM P1	HOURS	MODE
FROM MONDAY TO FRIDAY	0 - 6	Night/Eco
	6 - 9	Comfort
	9 - 16	Night/Eco
	16 - 23	Comfort
	23 - 0	Night/Eco
SATURDAY AND SUNDAY	0 - 7	Night/Eco
	7 - 23	Comfort
	23 - 0	Night/Eco

PROGRAM P2	HOURS	MODE
FROM MONDAY TO SUNDAY	0 - 7	Night/Eco
	7 - 23	Comfort
	23 - 0	Night/Eco

PROGRAM P3	HOURS	MODE
FROM MONDAY TO FRIDAY	0 - 6	Night/Eco
	6 - 9	Comfort
	9 - 13	Night/Eco
	13 - 23	Comfort
	23 - 0	Night/Eco
SATURDAY AND SUNDAY	0 - 7	Night/Eco
	7 - 23	Comfort
	23 - 0	Night/Eco

PROGRAM P4 - CUSTOM

With the "P4" program, you can set different temperatures ("Comfort" and "Night/Eco") over a 24 hour period for each day of the week.

SETTING THE CURRENT DAY AND TIME

Before going on with the P4 custom program setup, check that the hour and day of the week have been correctly set up.



If you fail to enter the setup in this way, key the "Mode" key until the icon appears on the display. Then press the "Mode" key again and hold it down until the number indicating the day flashes.

- 1
- 2
- 3
- 4

Adjust the day of the week by using the "+" and "-" keys (1=MON, 2=TUE, ... 7=SUN), then confirm by pressing the "Mode" selection key.



Repeat the same procedure for the hours. The minutes now start flashing. Use the "+" and "-" keys to set the minutes then press the key to confirm and exit or press the "Mode" key to enter the P4 program setup.

SETTING THE P4 PROGRAM

To enter the P4 custom program setup, press the "MODE" key when you finish setting the minutes (see SETTING THE CURRENT DAY AND TIME).

Start with the first day. Choose by means of the "+" and "-" keys, for each hour, between the "Comfort" temperature (two lines) and the "Night/Eco" temperature (single line).

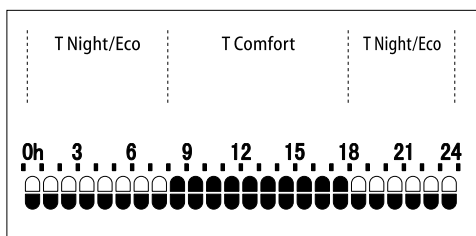

Press the "Mode" key to confirm and repeat the same procedure for each day of the week. The weekly program is now set.

The icon of the ASC function (see Ch. 4.3.1) starts flashing. Press the key to activate the function or the "-" key to de-activate it.

4.2.6 ENERGY SAVING

This fixes the temperature at 17 °C. "Energy Saving" mode reduces energy consumption when the room is left unused but a comfortable temperature needs to be maintained.



To activate "Energy Saving", press the "Mode" key until the "E 5" symbol is displayed in place of the hour/temperature.

4.3 FUNCTIONS

The appliance has a number of special functions to customise and optimise use.

4.3.1 ASC

This function measures the thermal inertia of the room and switches the radiator on in advance to ensure that the "Comfort" temperature is reached by the set time.

The function can switch the appliance on up to 2 hours early.



This function can be activated and operates only in "Chrono" mode. (See Ch. 4.2.5.)



A number of days of data acquisition are required to optimise the accuracy of the ASC function.

4.3.2 OPEN WINDOW

The "Open Window" function automatically detects the opening of a window which is present in the proximity of the radiator (for example during the housework) and it goes in "Anti-Freeze" mode, in order to prevent a useless heating and save energy. The function can also detect the closing of a window and reset the previous operating condition.

When switching the appliance on, the function is already active, ready to detect any open windows.



To activate or deactivate the function, press the key and hold it down until the icon appears or disappears from the display.

When an open window is detected, the "Open Window" icon flashes.



Now pressing the key cancels the "Open Window" action until detection of the next open window.

The icon stops flashing.

For the optimal operation of the function, it is recommended to install the appliance near a window (Fig. 9).

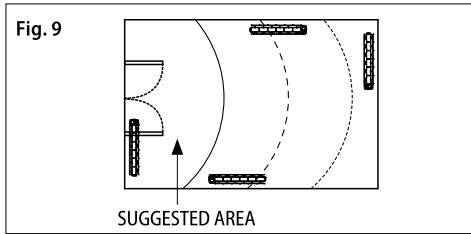

The appliance's reaction to the window openings and closings depends on multiple factors, among which the chosen temperature set point, the external temperature, the ventilation degree of the room, the radiator position in the room, presence of other heating sources.



The "Open Window" function cannot be activated or deactivated in "Standby" mode.



If the appliance has detected an open window, all the operating modes and the "Overdrive (2h)" function can be selected, however they will not be active until the window is detected as closed or the "Open Window" function is cancelled. The "Children Safety" and "Keypad Lock" functions remain active and can be activated and deactivated even when the appliance has detected an open window.

4.3.3 CHILDREN SAFETY

When the "Children Safety" function is activated, the surface temperature of the appliance is lower than in normal operation in the active mode ("Comfort", "Night/Eco",...) to avoid the risk of burns caused by brief accidental contact.

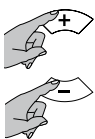

To activate the function, press the "+" and "-" keys together and hold them both down until the icon  appears on the display.

To deactivate the function, repeat the same operation.

"Children Safety" can be activated in all operating modes, including "Overdrive (2h)". The function cannot be activated when the appliance is in "Standby".

IMPORTANT:

When this function is active, the appliance heats at reduced power and therefore the room takes longer to warm up.

Even when this function active, children should still be supervised to make sure they are not in danger.



Always avoid prolonged contact between the appliance and the body.

If the appliance is already operating or is still hot after recent use and "Children Safety" is activated, it takes at least two hours for the temperature to drop to the lower value and the function to be operational.

4.3.4 OVERDRIVE (2H)

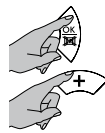
The "Overdrive (2h)" can be used to heat the room quickly.



To activate the function, press the  and "+" keys together and hold them both down until the  symbol appears on the display.

The minutes left until the end of the two hours are displayed in place of the time.

The appliance heats at the maximum power for 2 hours, independently from the temperature setting.

To deactivate "Overdrive (2h)" function at any time, press the two keys together as before.

After 2 hours since activation, the "Overdrive (2h)" exits automatically and the appliance returns into the previously selected operating mode.





The function "Children Safety" limits the heating power even when the function "Overdrive (2h)" is active.



If the appliance has detected an open window, the "Overdrive (2h)" function will not be active until the window is detected as closed or the "Open Window" function is cancelled (see Ch. 4.3.2), however the two-hour countdown continues.

4.3.5 HOLIDAY

In case you are out of home for an established number of days, it is possible to set up the radiator so that it stays in "Anti-Freeze" mode during all the period of absence. It will automatically turn on in the previously operating mode as soon as the preset number of days expires.

To activate the function, press the  and "-" keys together and hold them both down until the icon  appears on the display.



Then set up the desired number of days (maximum 45) by means of the "+" and "-" keys. The desired setting is autoconfirmed.



Now the LCD shows the  icon and the set number of days, which decreases as the days pass.



To deactivate the function at any time, press the  and "-" keys together.



4.3.6 KEYPAD LOCK

It is possible to lock the keypad to prevent accidental modifications.



To activate the function, press the "Mode" and "+" keys together and hold them both down until the icon  appears on the display.



To unlock the keypad, press the same two keys together as before.

The "Keypad Lock" icon will no longer appear on the LCD.

IMPORTANT: The "Keypad Lock" function does not inhibit the "Standby" key. This is therefore always active, even when the "Keypad Lock" function is enabled.

4.4 BEHAVIOURAL INDICATOR

The behavioural indicator allows you to check if the chosen temperature set point is aligned with the recommended guidelines, in order to avoid the waste of energy and reduce the energy consumption.

An arrow will appear by one of the three colored bars that represent the energy consumption in a qualitative way, according to the following scheme:



(a) **Green:** The chosen temperature set point is already lower than the recommended.

(b) **Yellow:** The chosen temperature set point is adequate, but it would be better to further decrease it.

(c) **Red:** The chosen temperature set point is high, it would be better to decrease it.

ATTENTION: The behavioural indicator gives an exclusively qualitative indication of the energy consumption. It is NOT an absolute measure.

4.5 INSTANTANEOUS POWER INDICATOR

This graphic provides an immediate indication of radiator power use (each sector represents 20% of the power).

IMPORTANT: In case of power down due to a black-out, all current settings are kept in memory with the exception of date and time.

If the power black-out occurs in "Chrono" mode, when power is restored, the radiator resumes functioning in "Energy Saving" mode.

IMPORTANT: If the appliance remains without power while the "Overdrive (2h)" function is enabled, the date and time settings are lost. When power is restored, the appliance exits the function and resumes functioning in the mode selected previously.

IMPORTANT: In case of power down while the "Holiday" function is enabled, when restored, the function remains active and the countdown of days to the end of the holiday resumes from the moment of its stop.

IMPORTANT: In case of power down while the "ASC" function is enabled, when restored, the function remains active but a few days will be required for it to become fully operational.

5. CLEANING



Before cleaning, make sure the appliance is turned off, cold and disconnected from the household mains.



To clean, just wipe with a soft damp cloth and neutral detergent. Never use abrasive or corrosive cleaning products or solvents.



To maintain efficiency, remove the dust from the surface and inside of the appliance at least twice a year using a vacuum cleaner.

6. MAINTENANCE



Should any technical problems arise, contact a qualified professional (recognised or authorised by the dealer or manufacturer) or your local dealer.



All operations on the appliance must be carried out by a qualified professional who before performing maintenance must make sure the appliance is turned off, cold and disconnected from the household mains.

GB

7. TROUBLESHOOTING

<p>The appliance does not heat up.</p>	<ul style="list-style-type: none"> • Check if the radiator is correctly connected to the mains power grid and powered. • Check the position of the mains switch of the installation. • Increase the temperature set point on the appliance regulator. • The heating element requires a few minutes for the appliance to become hot. Wait the necessary time. • The safety device has tripped. Eliminate the cause of overheating (for example, obstructions or covering).  • Disconnect the appliance from the household mains for a few minutes to reset the electronic system. • If it still does not heat up, contact your local dealer or a qualified professional.
<p>The appliance heats continuously.</p>	<ul style="list-style-type: none"> • Reduce the temperature set point on the appliance regulator. • Make sure the "Overdrive (2h)" function has not been activated accidentally. • If it continues to heat, contact your local dealer or a qualified professional.
<p>The room stays cold.</p>	<ul style="list-style-type: none"> • Make sure the power of the appliance is adequate for the room to be heated. • If the appliance is being used for the first time, the room takes at least a couple of hours to heat to the required temperature (setting the radiator to maximum does not raise the temperature more quickly).
<p>The appliance does not cool down.</p>	<ul style="list-style-type: none"> • The heating element requires a few dozen minutes to cool down. Wait the necessary time.
<p>Leaks of the liquid in the appliance.</p>	<ul style="list-style-type: none"> • Turn the appliance off and contact your local dealer. • Dry the leaks using gloves to protect from the chemical products. Keep children and pets away from the liquid.
<p>The appliance does not respond correctly to orders received from the Pilot Wire control unit.</p>	<ul style="list-style-type: none"> • Disconnect the appliance from the mains power supply (switch off the mains switch by moving it in the "O" position). Make sure the connection is correct (Fig.8) and the control unit is functioning correctly. • Contact a qualified professional.
<p>The appliance keeps on heating despite the window is open and the "Open Window" function is active.</p>	<ul style="list-style-type: none"> • It may be necessary to wait a few minutes before the function starts operating. • The difference between the outside and inside temperature may not be sufficient to activate the function. • Check that the positioning of the appliance comply with the requirements referred to in ch. 4.3.2 of this booklet. • Check that the space around the control box of the radiator is free from obstacles. • If the problem persists, contact your dealer or qualified personnel.
<p>The appliance does not resume heating after the window is closed and the "Open Window" function is active.</p>	<ul style="list-style-type: none"> • It may be necessary to wait a few minutes before before the sensor detects the window closing. • Check that the space around the control box of the radiator is free from obstacles. • Deactivate and activate the function again. • Should the response time of the function be too long, you can at any time stop the radiator manually. • If the problem persists, contact your dealer or qualified personnel.
<p>The display shows "ALL".</p>	<ul style="list-style-type: none"> • The temperature sensor is malfunctioning. Turn off the appliance and contact your dealer.

8. GUARANTEE



You are recommended to keep all parts of the packaging in case the appliance needs to be returned to the dealer. The appliance must arrive complete and undamaged in order to maintain the validity of the guarantee.

The manufacturer guarantees customers all the rights specified in European Directive 1999/44/EC and the consumer rights recognised by national legislation.

The guarantee specifically covers all non-conformities and production defects present at the moment of sale or becoming evident within two years from the date of purchase and gives the customer the right to free repair of the defective product or replacement should repair be impossible.

The above rights are invalidated in the following cases:

- defects caused by uses other than those specified in the instructions, which are an integral part of the sales contract;
- defects caused by accidental breakage, negligence or tampering.

Operations involved in installation, connection to the household mains and maintenance described in these instructions are not covered by the guarantee.

The Manufacturer declines all liability for damage or injury caused directly or indirectly to people, objects or pets as a result of the failure to apply these instructions, with particular reference to warnings regarding installation, start-up and use of the product.

To claim the above rights, the Customer must contact his/her dealer and present a valid proof of purchase issued by the seller, complete with date of purchase.

9. DISPOSAL



Make sure the power cable is disconnected from the power line before performing any operation. To remove the appliance, follow the procedure for fixing to the wall in reverse (Scheme 1).

To dispose of the appliance, comply with current legislation for the disposal and management of waste.



Important information for correct disposal of the product in accordance with EC Directive 2012/19/EC.

At the end of its working life, the product must not be disposed of as urban waste.

It must be taken to a special local authority differentiated waste collection centre or to a dealer providing this service.



This appliance complies with European Directives:

- 2014/30/EU on electromagnetic compatibility
- 2014/35/EU on low voltage
- 2011/65/EU on restriction of the use of certain hazardous substances



ELECTRICAL CONNECTIONS WITH PLUG READ CAREFULLY

Before plugging into the mains socket, make sure that the voltage of your mains power supply matches the V value reported on the rating plate of the appliance and that the socket and power line are appropriate for the required load (also reported on the rating plate).

Make sure that the power line is fitted with a disconnecting switch allowing the appliance to be disconnected completely from the household mains, in accordance with the regulation in force.

The power line must be fitted at least with a 30 mA RCD (high sensitivity residual current protection device).

All the references about the "Pilot Wire" (Fil Pilote) mode and related wiring present in the instruction manual must be ignored, since operating mode is not available on this product.

Information requirements for electric local space heaters

GB

Model identifier(s): (see the rating plate on the product)

Contact details:

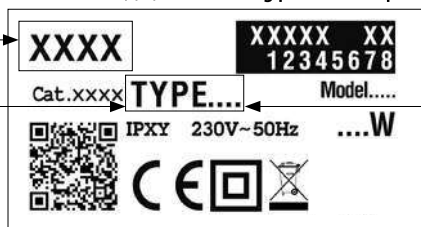

HEAT OUTPUT	TYPE	VALUE	UNIT
Nominal heat output (P_{nom})	xVExx07x	0,7	kW
	xVExx09x	0,9	
	xVExx10x	1,0	
	xVExx12x	1,2	
	xVExx15x	1,5	
	xVExx18x	1,8	
	xVExx20x	2,0	
Minimum heat output (indicative) (P_{min})	xVExx07x	0,0	kW
	xVExx09x		
	xVExx10x		
	xVExx12x		
	xVExx15x		
	xVExx18x		
	xVExx20x		
Maximum continuous heat output ($P_{max,c}$)	xVExx07x	0,7	kW
	xVExx09x	0,9	
	xVExx10x	1,0	
	xVExx12x	1,2	
	xVExx15x	1,5	
	xVExx18x	1,8	
	xVExx20x	2,0	

AUXILIARY POWER CONSUMPTION	TYPE	VALUE	UNIT
At nominal heat output ($e_{l,max}$)	xVExx07x	0,000	kW
	xVExx09x		
	xVExx10x		
	xVExx12x		
	xVExx15x		
	xVExx18x		
	xVExx20x		
At minimum heat output ($e_{l,min}$)	xVExx07x	0,000	kW
	xVExx09x		
	xVExx10x		
	xVExx12x		
	xVExx15x		
	xVExx18x		
	xVExx20x		
In standby mode ($e_{l,ss}$)	xVExx07x	0,000	kW
	xVExx09x		
	xVExx10x		
	xVExx12x		
	xVExx15x		
	xVExx18x		
	xVExx20x		

Type of heat output/room temperature control

- single stage heat output, no room temperature control [NO]
- two or more manual stages, no room temperature control [NO]
- with mechanic thermostat room temperature control [NO]
- with electronic room temperature control [NO]
- electronic room temperature control plus day timer [NO]
- electronic room temperature control plus week timer [YES]

Other control options

- room temperature control, with presence detection [NO]
- room temperature control, with open window detection [YES]
- with distance control option [NO]
- with adaptive start control [YES]
- with working time limitation [NO]
- with black bulb sensor [NO]

PICTOGRAMMES UTILISÉS DANS CETTE NOTICE



ATTENTION!
DANGER POUR LA SÉCURITÉ DES PERSONNES, DES ANIMAUX DOMESTIQUES ET DES BIENS.



ATTENTION!
DANGER DE DÉCHARGES ÉLECTRIQUES.



ATTENTION!
DANGER DE DOMMAGES AU PRODUIT.



ATTENTION!
TEMPÉRATURES ÉLEVÉES.
RISQUE DE BRÛLURE.



CONSEIL POUR LE BON FONCTIONNEMENT.



NE PAS COUVRIR!

FR

MISE EN GARDE



ATTENTION - Certaines parties de l'appareil peuvent devenir très chaudes et provoquer des brûlures. Faire preuve d'une attention particulière en présence d'enfants ou de personnes vulnérables.



Il convient de maintenir à distance de cet appareil les enfants de moins de 3 ans, à moins qu'ils ne soient sous une surveillance continue.

Les enfants entre 3 et 8 ans doivent exclusivement pouvoir allumer/éteindre l'appareil, à condition que ce dernier soit installé dans sa position de fonctionnement normale et que les enfants soient surveillés ou familiarisés avec le fonctionnement et les risques liés à l'utilisation du radiateur.

Les enfants entre 3 et 8 ans ne doivent pas régler, nettoyer ni effectuer les opérations d'entretien de l'appareil.

Cet appareil peut être utilisé par des enfants âgés d'au moins 8 ans et par des personnes ayant des capacités physiques, sensorielles ou mentales réduites ou ne disposant pas de l'expérience ou des connaissances nécessaires, à condition de les surveiller ou qu'elles aient reçues les instructions concernant l'utilisation sûre de l'appareil et qu'elles aient compris les dangers inhérents à celui-ci. Les enfants ne doivent pas jouer avec l'appareil. Le nettoyage et l'entretien à la charge de l'utilisateur ne peuvent pas être effectués par des enfants, sauf s'ils sont surveillés.



Ne pas installer l'appareil:

- juste en dessous ou devant une prise de courant ou une boîte de dérivation (Fig. 5)
- en contact avec le mur ou avec le sol
- près de rideaux ou matériaux inflammables ou combustibles ou de récipients sous pression.



MISE EN GARDE:

Respecter les distances indiquées dans les figures 3,4.



Installer et utiliser l'appareil uniquement comme indiqué dans les instructions.



Si le câble d'alimentation est endommagé, il doit être remplacé par le fabricant, son service après vente ou des personnes de qualification similaire afin d'éviter un danger. Ne pas utiliser l'appareil si le boîtier électronique est endommagé.



S'assurer que la ligne d'alimentation est munie d'un dispositif de sectionnement permettant d'isoler l'appareil, et le Fil Pilote s'il est présent, du réseau électrique, selon la réglementation en vigueur.



MISE EN GARDE: Pour éviter une surchauffe, ne pas couvrir l'appareil de chauffage (Fig. 7). En outre, ne pas bloquer le flux d'air, en insérant des matériaux à l'intérieur de l'appareil.



Lorsque l'appareil de chauffage est mis au rebut, respecter les réglementations concernant l'élimination et la gestion des déchets.

Les appareils avec prise ne sont pas pour le marché français

1. CARACTÉRISTIQUES DE L'APPAREIL

Voltage: 230 V ~ 50 Hz

Classe d'isolation: II 

Degré de protection: IPx4

TYPE	Puissance [W]	Longueur [cm]	Hauteur [cm]	Poids [kg]	Courant nominal [A]
CVE0610F	1000	55	58	16	4,5
CVE0915F	1500	79	58	24	6,5
CVE1220F	2000	104	58	32	9
DVE0610F	1000	55	58	11	4,5
DVE0915F	1500	79	58	16	6,5
DVE1118F	1800	95	58	19	8
EVE0610F	1000	55	58	17	4,5
EVE0915F	1500	79	58	25	6,5
EVE1220F	2000	103	58	33	9

Tableau 1

 Les caractéristiques techniques de l'appareil sont indiquées sur l'étiquette placée sur le côté du radiateur (Fig. 1).

A	Marque/Fabricant	F	Double isolation
B	Modèle, type, catégorie	G	Élimination
C	Code Bidimensionnel (QR)	H	Labels de qualité
D	Degré de protection	I	Voltage et Puissance
E	Marquage CE	L	Numéro de série

2. INFORMATIONS GÉNÉRALES

 Déballer l'appareil et le poser sur les protections en polystyrène ou sur un tapis.

Contenu de l'emballage:

- l'appareil
- kit de fixation
- notice

 Lire attentivement la totalité des instructions avant d'installer et d'utiliser l'appareil. Les conserver pour toute future consultation.

 Installer et utiliser l'appareil uniquement comme indiqué dans les instructions.

 Toutefois cette notice ne couvre pas toutes les situations pouvant se présenter. Faire preuve de bon sens et de prudence lors de l'installation, le fonctionnement et l'entretien de l'appareil.

 Il est interdit de modifier de quelque manière que ce soit les caractéristiques de l'appareil et de retirer les parties fixes, quelles qu'elles soient, y compris les bouchons. S'assurer que l'appareil est en bon état. Ne pas utiliser l'appareil s'il est endommagé, mais contacter le vendeur ou un professionnel qualifié.

 Les matériaux utilisés pour l'emballage sont recyclables. Il est donc conseillé de les déposer dans les conteneurs de tri sélectif.

3. POSITIONNEMENT ET INSTALLATION



Cet appareil a été conçu pour chauffer des pièces et est destiné à un usage domestique ou similaire. Il ne doit pas être destiné à un autre usage.

L'appareil doit être fixé au mur, comme indiqué dans la notice. Installer l'appareil de façon à ce que le thermostat soit placé en bas (Fig. 2).



Dans la salle de bains (équipée d'une baignoire ou d'une douche) installer l'appareil en-dehors de la zone de sécurité 1.

Installer l'appareil de façon à ce que le boîtier électronique et les autres dispositifs de commande ne puissent pas être touchés par une personne se trouvant dans la baignoire ou la douche. Il est interdit d'utiliser une fiche pour le branchement de l'appareil.



Respecter les distances indiquées dans les figures 3,4.



Ne pas installer l'appareil:

- juste en dessous ou devant une prise de courant ou une boîte de dérivation (Fig. 5)
- en contact avec le mur ou avec le sol
- près de rideaux ou matériaux inflammables ou combustibles ou de récipients sous pression.



Vérifier qu'il n'y ait pas de tuyaux ou câbles électriques dans le mur qui puissent être endommagés pendant l'installation.



L'appareil est équipé d'un capteur en mesure de détecter l'ouverture d'une fenêtre au-dessus de celui-ci. Pour le bon fonctionnement de la fonction "Fenêtre Ouverte" il est conseillé de vérifier et de suivre les indications indiquées au Chap. 4.3.2 avant de fixer l'appareil au mur.

3.1 FIXATION AU MUR



S'assurer que les vis et les chevilles incluses dans le sachet de fixation soient adaptées au type de mur sur lequel l'appareil est installé. En cas de doute s'adresser à un professionnel qualifié ou au vendeur.



Procéder à l'installation comme indiqué à l'intérieur du volet de la couverture (Schéma 1) en respectant la distance minimum entre la partie inférieure du radiateur et le sol (Fig. 3).



Pendant l'installation s'assurer que le câble d'alimentation est déconnecté électriquement.

3.2 BRANCHEMENT ÉLECTRIQUE



MISE EN GARDE

L'appareil doit être installé par un professionnel et conformément aux réglementations nationales et locales en vigueur.

Avant d'installer l'appareil, s'assurer qu'il n'est pas alimenté électriquement et que l'interrupteur général de l'installation est sur "0".



La tension d'alimentation de l'appareil est de 230 V ~ 50 Hz. S'assurer que la ligne électrique est adaptée à la puissance de l'appareil, indiquée dans le tableau 1.



S'assurer que la ligne d'alimentation est munie d'un dispositif de sectionnement permettant d'isoler l'appareil, et le Fil Pilote s'il est présent, du réseau électrique, selon la réglementation en vigueur.

En cas d'installation dans une salle de bains, la ligne électrique doit être munie d'un dispositif de protection différentiel à haute sensibilité ayant un courant nominal résiduel de 30 mA.

La ligne d'alimentation et le boîtier du Fil Pilote doivent être protégés par le même dispositif de protection différentiel.

Pour le branchement électrique, utiliser une boîte de dérivation.

En cas d'installation dans une pièce humide (cuisine, salle de bain), le branchement de l'appareil au circuit électrique doit se trouver à au moins 25 cm du sol.

Respecter scrupuleusement le schéma de branchement électrique indiqué dans la figure 8.



Si le Fil Pilote n'est pas raccordé au boîtier de programmation, il faut l'isoler. Le Fil Pilote ne doit jamais être raccordé à la terre.



S'assurer que le câble d'alimentation ne peut en aucun cas entrer en contact avec la surface de l'appareil (Fig. 6).

4. RÉGLAGE ET FONCTIONNEMENT



L'appareil est conçu pour chauffer une pièce. Certaines parties de l'appareil peuvent devenir très chaudes et provoquer des brûlures. Faire preuve d'une attention particulière en présence d'enfants ou de personnes vulnérables.



Maintenir les matériaux combustibles, inflammables et les récipients sous pression (par ex. spray, extincteurs) à au moins 50 cm de l'appareil. Ne vaporiser aucune substance, quelle qu'elle soit, sur la surface de l'appareil.



Ne pas toucher l'appareil avec les mains ou les pieds mouillés ou humides. Éviter tout contact de la commande électronique avec de l'eau ou d'autres liquides. Le cas échéant, couper le courant et laisser sécher complètement l'appareil.



Lorsque l'appareil est installé en altitude, la température de l'air chauffé est plus élevée.



À l'occasion de la première mise en route il est normal que l'appareil dégage une odeur qui disparaîtra rapidement. Il est conseillé d'aérer la pièce après la première utilisation.



En cas de mise en service dans des locaux non réchauffés, l'appareil peut émettre des sons métalliques dus à la dilatation des matériaux.



Les traces d'huile éventuellement remarquées au bas de l'appareil durant le montage ou la première mise en service sont généralement des résidus de fabrication. Nettoyer les traces avec précaution tous les deux jours. Si le phénomène persiste, se conformer aux instructions du Chap. 7.

FR

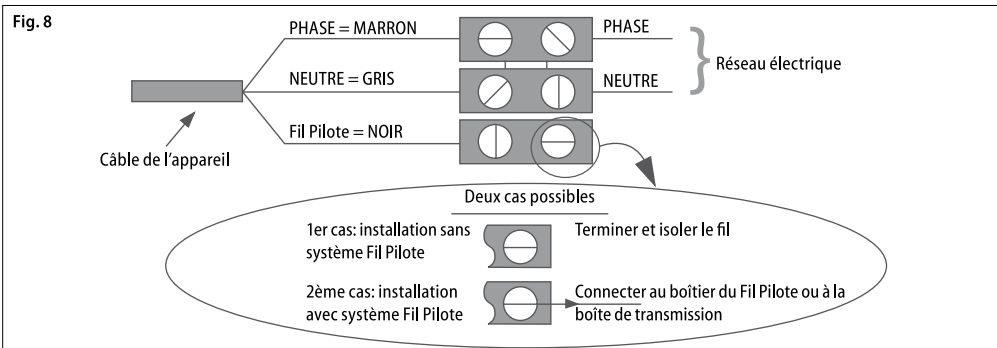

UTILISATION DU RADIATEUR À L'AIDE DU PANNEAU DE CONTRÔLE:

FR

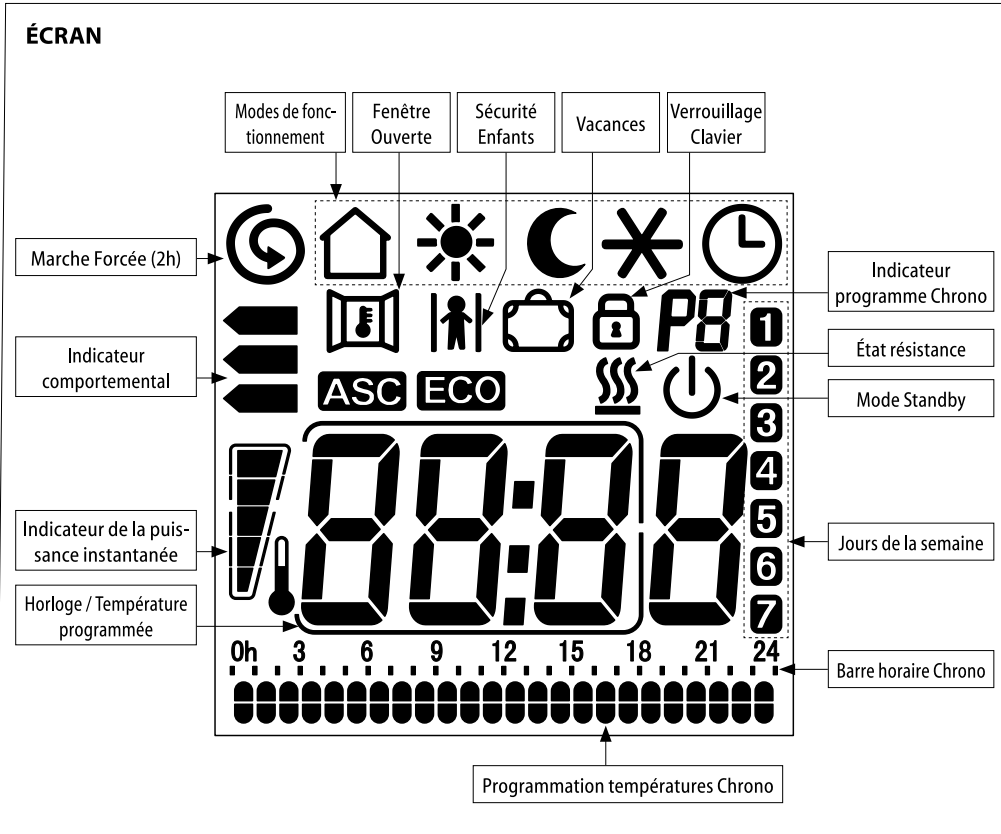
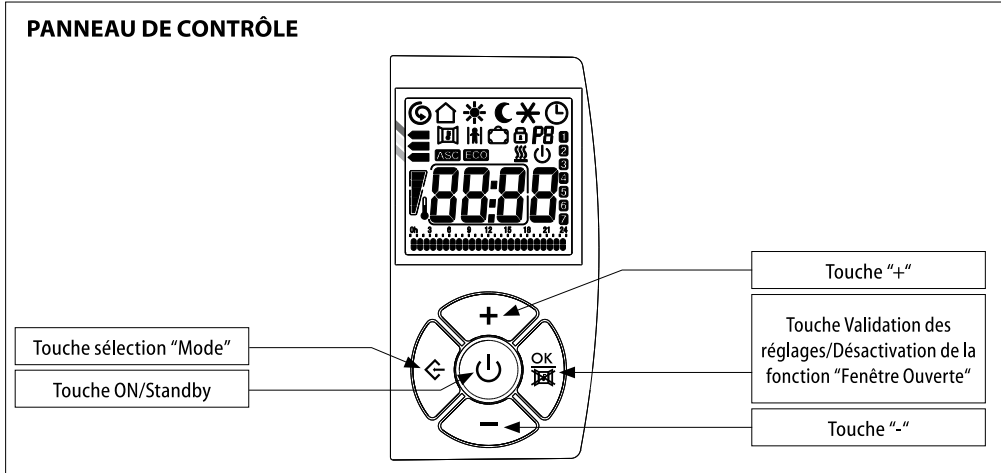

4.1 MODE ON/STANDBY



En mode "Standby" l'écran affiche l'icône , l'heure et le jour de la semaine. Tous les modes, y compris le "Fil Pilote" sont désactivés mais l'appareil reste sous tension dans l'attente d'une commande.



Pour allumer ou éteindre l'appareil appuyer sur la touche "Standby". Le radiateur se met en marche dans le mode de fonctionnement sélectionné avant l'arrêt et émet un signal sonore.

L'écran montre l'heure dans le mode "Chrono", la température réglée est montrée dans les autres modes.

L'appareil indique par un double signal sonore l'entrée en mode "Standby" et par un signal sonore prolongé la sortie de celui-ci.



CHRONO

Ce mode permet de sélectionner l'un des trois programmes de chronothermostat prédéfinis ou le programme personnalisable. Ce dernier permet une programmation journalière et hebdomadaire avec deux niveaux de température ("Confort" et "Nuit/Eco").

Toutes les commandes du "Fil Pilote" sont inactives.



ENERGY SAVING

Ce mode permet de réduire les consommations, quand la pièce n'est pas occupée. La température est fixée à 17°C.

Toutes les commandes du "Fil Pilote" sont inactives.







Quand le symbole  est affiché sur l'écran la résistance est active.

4.2 MODES DE FONCTIONNEMENT

L'appareil est doté de 6 modes de fonctionnement qui permettent de chauffer la pièce selon ses besoins.



Appuyer sur la touche "Mode" pour choisir le mode de fonctionnement voulu. Une icône sur l'écran indique le mode de fonctionnement:

	Fil Pilote		Confort
	Nuit/Eco		Hors-Gel
	Chrono		Energy Saving



FIL PILOTE

La température est définie par le "Fil Pilote". Toutes les commandes du "Fil Pilote" sont actives.



CONFORT

La température de "Confort" correspond à la température souhaitée par l'utilisateur. Toutes les commandes du "Fil Pilote" sont inactives.



NUIT/ECO

Le mode "Nuit/Eco" maintient une température confortable avec une consommation d'énergie réduite. Toutes les commandes du "Fil Pilote" sont inactives.



HORS-GEL

En mode "Hors-gel" la température minimale est fixée à 7°C. L'appareil s'allume automatiquement si la température ambiante descend audessous de 7°C. Toutes les commandes du "Fil Pilote" sont inactives.

4.2.1 FIL PILOTE

Pour activer le mode "Fil Pilote":





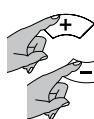



Appuyer sur la touche "Mode" jusqu'à ce que l'icône  soit visible sur l'écran.



L'utilisateur peut uniquement régler la température "Confort" sur l'appareil.

Sélectionner la température désirée à l'aide des touches "+" et "-".

L'habitation doit être équipée d'un système de gestion qui supporte ce type de technologie. Dans ce cas, pour vérifier la bonne transmission des ordres de programmation, il est possible d'utiliser le schéma suivant, selon le mode programmé:

Mode	Confort	Nuit/Eco (Confort -3,5°C)	Hors-Gel	Standby	Confort -1°C	Confort -2°C
Signal à transmettre						
Tension entre Fil Pilote et neutre	0 volt	230 volt	115 volt Négatif	115 volt Positif	230 volt Pour un intervalle de 3 s	230 volt Pour un intervalle de 7 s

L'icône du mode sélectionné par la centrale (Standby, Confort, Nuit/Eco, Hors-gel) s'affiche sur l'écran à coté de l'icône .

Si le Fil Pilote n'est pas relié, le mode "Confort" est automatiquement sélectionné.

4.2.2 CONFORT ✱

La température du "Confort" correspond à la température désirée par l'utilisateur.

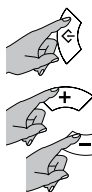

Appuyer sur la touche "Mode" jusqu'à ce que l'icône ✱ soit visible sur l'écran.

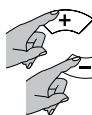

Sélectionner la température désirée à l'aide des touches "+" et "-".
L'intervalle de réglage est compris entre 7 °C et 32 °C.

4.2.3 NUIT/ECO

En mode "Nuit/Eco", la température programmée doit être égale ou inférieure à la température "Confort". Si vous voulez régler une température "Confort" inférieure à "Nuit/Eco", cette dernière variera donc en conséquence.



Appuyer sur la touche "Mode" jusqu'à ce que l'icône  soit visible sur l'écran.

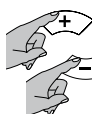

Sélectionner la température désirée à l'aide des touches "+" et "-".

Il est conseillé d'utiliser ce mode la nuit et quand la pièce n'est pas occupée pendant 2 heures ou plus.

4.2.4 HORS-GEL ✱

En mode "Hors-Gel" la température est fixée à 7 °C. L'appareil se met en marche automatiquement lorsque la température ambiante est inférieure à 7 °C et, avec une consommation minime d'énergie, empêche que la température dans la pièce n'atteigne la température de congélation.



Appuyer sur la touche "Mode" jusqu'à ce que l'icône ✱ soit visible sur l'écran.

Il est conseillé d'utiliser ce mode quand la pièce reste inoccupée pendant un ou plusieurs jours.

4.2.5 CHRONO

Le mode "Chrono" permet de sélectionner l'un des trois programmes de chronothermostat prédéfinis ou le programme personnalisable. Ce dernier permet de définir plusieurs températures ("Confort" et "Nuit/Eco") sur une période de 24 h et pour chaque jour de la semaine.

SÉLECTION DU PROGRAMME



Appuyer sur la touche "Mode" jusqu'à affichage de l'icône . Appuyer ensuite simultanément sur la touche "Mode" et sur la touche "-" pendant 3 sec. minimum.

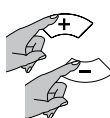

Le numéro qui indique le programme (P1, P2, P3 et P4) clignote: appuyer sur les touches "+" et "-" pour sélectionner le programme voulu. Appuyer sur la touche "Mode" pour confirmer.

L'icône de la fonction ASC (voir chap. 4.3.1) se met à clignoter, appuyer sur la touche  pour activer la fonction ou sur la touche "-" pour la désactiver.

PROGRAMME P1	HEURES	MODE
DU LUNDI AU VENDREDI	0 - 6	Nuit/Eco
	6 - 9	Confort
	9 - 16	Nuit/Eco
	16 - 23	Confort
	23 - 0	Nuit/Eco
SAMEDI ET DIMANCHE	0 - 7	Nuit/Eco
	7 - 23	Confort
	23 - 0	Nuit/Eco

PROGRAMME P2	HEURES	MODE
DU LUNDI AU DIMANCHE	0 - 7	Nuit/Eco
	7 - 23	Confort
	23 - 0	Nuit/Eco

PROGRAMME P3	HEURES	MODE
DU LUNDI AU VENDREDI	0 - 6	Nuit/Eco
	6 - 9	Confort
	9 - 13	Nuit/Eco
	13 - 23	Confort
	23 - 0	Nuit/Eco
SAMEDI ET DIMANCHE	0 - 7	Nuit/Eco
	7 - 23	Confort
	23 - 0	Nuit/Eco

PROGRAMME P4 - PERSONNALISÉ

Le programme P4 permet de configurer différentes températures ("Confort" et "Nuit/Eco") sur une période de 24 h et pour chaque jour de la semaine.

SÉLECTIONNER LE JOUR ET L'HEURE

Avant de configurer le programme personnalisable P4 vérifier que l'heure et le jour de la semaine sont exacts.



Si ce n'est pas le cas, appuyer sur la touche "Mode" jusqu'à ce que l'icône ☹ s'affiche. Puis appuyer de nouveau sur la touche "Mode" en la maintenant enfoncée jusqu'à ce que le nombre qui indique le jour clignote.

- 1
- 2
- 3
- 4

Appuyer sur les touches "+" et "-" pour définir le jour de la semaine (1=LUN,2=MAR,... 7=DIM). Appuyer sur la touche "Mode" pour valider.

20:30

Répéter cette même procédure pour régler l'heure.

20:30

Les minutes clignotent, utiliser les touches "+" et "-" pour les régler et appuyer sur pour confirmer et quitter ou sur la touche "Mode" pour entrer dans la configuration du programme P4.

CONFIGURATION DU PROGRAMME P4

Pour paramétrer le programme personnalisé P4 appuyer sur la touche "MODE" à la fin du réglage des minutes (voir RÉGLAGE DE L'HEURE).

En partant du premier jour sélectionner la séquence horaire voulue à l'aide des touches "+" et "-" en choisissant, pour chaque heure, entre la température "Confort" (double cran) et la température "Nuit/Eco" (simple cran).

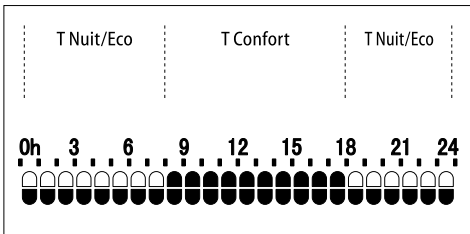

Appuyer sur la touche "Mode" pour confirmer et répéter la procédure pour chaque jour de la semaine. La programmation hebdomadaire est alors réglée.

L'icône de la fonction ASC (voir chap 4.3.1) clignote, appuyer sur la touche pour activer la fonction ou sur la touche "-" pour la désactiver.

4.2.6 ENERGY SAVING

De cette manière la température est fixée à 17°C. L'"Energy Saving" permet de réduire les consommations lorsque la pièce n'est pas occupée tout en maintenant une température confortable.



Pour activer l'"Energy Saving" appuyer sur la touche "Mode", jusqu'à ce que le symbole "E S" s'affiche sur l'écran à la place de l'heure/température.

4.3 FONCTIONS

L'appareil est muni de fonctions spéciales qui permettent de personnaliser et d'optimiser l'utilisation de l'appareil.

4.3.1 ASC

Cette fonction mesure l'inertie de la pièce pour atteindre la température programmée et avance la mise en marche du radiateur pour que la température "Confort" soit obtenue à l'heure programmée.

La fonction peut avancer la mise en marche de l'appareil de 2 heures au maximum.



Cette fonction ne peut être activée et n'est opérationnelle qu'en mode "Chrono" (voir Chap. 4.2.5).



Quelques jours d'acquisition des données sont nécessaires pour un fonctionnement optimal de l'ASC.

4.3.2 FENÊTRE OUVERTE

La fonction "Fenêtre Ouverte" permet à l'appareil de détecter de façon autonome l'ouverture d'une fenêtre à proximité du radiateur (par exemple lorsqu'on fait le ménage) et de se mettre en mode "Hors-Gel" afin d'éviter de chauffer inutilement la pièce et donc de gaspiller l'énergie. De la même façon il est en mesure de détecter la fermeture de la fenêtre et de rétablir le mode de fonctionnement précédemment programmé.

Lors de l'allumage de l'appareil la fonction est active, prête à détecter l'ouverture d'une fenêtre.



Pour activer ou désactiver la fonction appuyer sur la touche et la maintenir enfoncée jusqu'à ce que l'icône s'affiche ou disparaisse de l'écran.

Quand l'ouverture d'une fenêtre est détectée l'icône "Fenêtre ouverte" clignote.

Il est alors possible, en appuyant sur la touche , d'annuler l'action de "Fenêtre ouverte" jusqu'à ce qu'une fenêtre ouverte soit de nouveau détectée.

L'icône arrête de clignoter.



Pour assurer une action optimale de la fonction il est conseillé d'installer l'appareil près d'une fenêtre (Fig. 9).

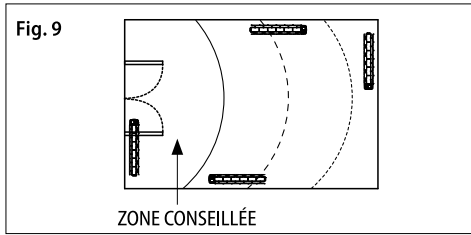

La réponse de l'appareil à l'ouverture et à la fermeture de la fenêtre dépend de divers facteurs comme par exemple la température programmée sur l'appareil, la température extérieure, le degré de ventilation de la pièce où est installé le radiateur, la position du radiateur dans la pièce, la présence d'autres sources de chaleur.



La fonction "Fenêtre Ouverte" ne peut pas être activée ou désactivée en mode "Standby".



Si l'appareil a détecté l'ouverture d'une fenêtre tous les modes de fonctionnement et la fonction "Marche Forcée (2h)" peuvent être sélectionnés mais ils ne sont activés que lorsque la fermeture de la fenêtre a été détectée ou que la fonction "Fenêtre ouverte" a été annulée. Les fonctions "Sécurité Enfants" et "Verrouillage Clavier" restent actives et peuvent être activées ou désactivées même quand l'appareil a détecté l'ouverture d'une fenêtre.

4.3.3 SÉCURITÉ ENFANTS

Quand on active la fonction "Sécurité Enfants" la température superficielle de l'appareil est réduite par rapport au fonctionnement normal du mode activé ("Confort", "Nuit/Eco",...) de façon à diminuer le risque de brûlures en cas de contact rapide et accidentel.

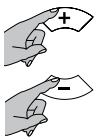

Pour activer la fonction appuyer simultanément sur les touches "+" et "-" en les maintenant enfoncées jusqu'à ce que l'icône  s'affiche sur l'écran.

Effectuer la même opération pour désactiver la fonction.

La "Sécurité Enfants" peut être activée dans tous les modes de fonctionnement et également dans la fonction "Marche Forcée (2h)". La fonction ne peut pas être activée si l'appareil est en "Standby".

REMARQUES IMPORTANTES:

Cette fonction réduit l'énergie thermique dégagée par l'appareil et le chauffage de la pièce est donc plus lent.

L'utilisation de cette fonction ne dispense pas de surveiller les enfants pour éviter tout risque d'accident.



Éviter dans tous les cas un contact prolongé avec l'appareil.

Si l'appareil est déjà en fonction ou est encore chaud lors de l'activation de la "Sécurité Enfants", deux heures min. sont nécessaires pour l'abaissement de la température et l'opérationnalité de la fonction.

4.3.4 MARCHÉ FORCÉE (2H)

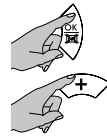
La fonction "Marche Forcée (2h)" permet de chauffer rapidement la pièce.



Pour activer la fonction appuyer simultanément sur les touches  et "+" en les maintenant enfoncées jusqu'à ce que le symbole  s'affiche sur l'écran.

Les minutes restantes avant la fin des deux heures sont affichées sur l'écran à la place de l'heure.

L'appareil chauffe pendant deux heures à la puissance maximale en ignorant la programmation de température précédente.

Pour désactiver la fonction "Marche Forcée (2h)", appuyer simultanément sur les deux touches comme précédemment. Deux heures après son activation, la fonction "Marche Forcée (2h)" est automatiquement désactivée et l'appareil revient au mode de fonctionnement précédemment sélectionné.





La fonction "Sécurité Enfants" limite la puissance du radiateur également lorsque la fonction "Marche Forcée (2h)" est activée.



Si l'appareil a détecté l'ouverture d'une fenêtre la fonction "Marche forcée (2h)" n'est activée que lorsque la fermeture de la fenêtre a été détectée ou que la fonction "Fenêtre ouverte" a été annulée (voir Chap. 4.3.2), toutefois le compte à rebours des deux heures continue.

4.3.5 VACANCES

Si on s'absente pendant plusieurs jours il est possible de programmer le radiateur de façon à ce qu'il reste en mode "Hors-Gel" pendant toute la période d'absence et qu'il se remette en marche automatiquement dans le mode précédemment sélectionné à la fin de la durée programmée.

Pour activer la fonction appuyer simultanément sur les touches  et “-” en les maintenant enfoncées jusqu’à ce que l’icône  s’affiche sur l’écran.

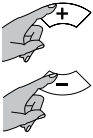

À l’aide des touches “+” et “-” programmer le nombre de jours (maximum 45 jours).

La programmation voulue est automatique-ment confirmée.

L’écran affiche l’icône  et le compte à rebours du nombre de jours restants.



Pour interrompre la fonction à tout moment appuyer simultanément sur les touches  et “-”.

4.3.6 VERROUILLAGE CLAVIER

Il est possible de verrouiller le clavier de commande pour éviter toute modification accidentelle.

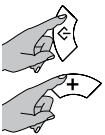

Pour activer la fonction appuyer simultanément sur les touches “Mode” et “+” en les maintenant enfoncées jusqu’à ce que l’icône  s’affiche sur l’écran.

Pour déverrouiller le clavier, appuyer simultanément sur les deux touches comme précédemment.

L’icône “Verrouillage Clavier” n’est plus affichée.

IMPORTANT: La fonction “Verrouillage Clavier” ne bloque pas la touche “Standby” qui reste donc toujours fonctionnelle même quand la fonction “Verrouillage Clavier” est activée.

4.4 INDICATEUR COMPORTEMENTAL

L’indicateur comportemental vous permet de vérifier si la température que vous avez programmée est dans la plage recommandée pour éviter les gaspillages et réduire la consommation énergétique.

Une flèche se positionnera en face d’une des trois barres colorées qui représentent qualitativement la consommation énergétique selon le schéma suivant:

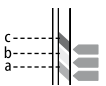

(a) **Vert:** la température choisie est inférieure à celle recommandée.

(b) **Jaune:** la température est adaptée, mais il est conseillé de la réduire légèrement.

(c) **Rouge:** la température choisie est élevée, il serait judicieux de la réduire.

ATTENTION! L’indicateur fournit une indication uniquement qualitative de la consommation d’énergie, pas une mesure absolue.

4.5 INDICATEUR DE LA PUISSANCE INSTANTANÉE

Ce diagramme indique immédiatement la puissance utilisée par le radiateur (chaque secteur correspond à 20 % de la puissance).

IMPORTANT: En cas de coupure de courant seul le réglage de la date et de l’heure est perdu, toutes les autres programmations courantes sont conservées.

Si la coupure de courant se produit en mode “Chrono” lorsque le courant est rétabli le radiateur se remet en marche en mode “Energy Saving”.

IMPORTANT: En cas de coupure de courant pendant que la fonction “Marche forcée (2h)” est activée, lorsque le courant est rétabli la programmation de la date et de l’heure est perdue et l’appareil quitte la fonction et revient au mode de fonctionnement précédemment sélectionné.

IMPORTANT: En cas de coupure de courant pendant que la fonction “Vacances” est activée lorsque le courant est rétabli la fonction reste active et reprend le compte à rebours des jours manquant au moment de l’interruption.

IMPORTANT: En cas de coupure de courant pendant que la fonction “ASC” est active lorsque le courant est rétabli la fonction reste active et a besoin de quelques jours pour redevenir pleinement opérationnelle.

5. NETTOYAGE



Avant toute opération de nettoyage, s’assurer que l’appareil est éteint et froid.



Pour le nettoyage, il suffit de passer un chiffon humide et doux avec un peu de détergent neutre. Ne pas utiliser de détergents abrasifs, corrosifs ou de solvants.



Pour garantir le bon fonctionnement de l’appareil, éliminer la poussière sur la surface et à l’intérieur de l’appareil au moins deux fois par an à l’aide d’un aspirateur.

6. ENTRETIEN



En cas de problèmes techniques, s'adresser à un professionnel qualifié (agréé par le vendeur ou le fabricant) ou contacter le vendeur.



Toute intervention sur l'appareil doit être effectuée par un professionnel qualifié qui, avant toute opération d'entretien, doit s'assurer que l'appareil est éteint, froid et déconnecté électriquement.

FR

7. PROBLÈMES ET SOLUTIONS

L'appareil ne chauffe pas.	<ul style="list-style-type: none"> • Contrôler qu'il y ait du courant et que l'appareil soit branché correctement. • Vérifier la position de l'interrupteur général. • Augmenter la température programmée sur le régulateur de l'appareil. • Avec ce type de résistance il faut plusieurs dizaines de minutes avant que l'appareil ne chauffe. Attendre le temps nécessaire. • Le dispositif de sécurité s'est déclenché. Eliminer la cause de la surchauffe (par exemple obstructions, couvertures).  • Déconnecter électriquement l'appareil pendant quelques minutes de façon à réinitialiser le système électronique. • S'il ne chauffe toujours pas, contacter le vendeur ou un professionnel qualifié.
L'appareil chauffe continuellement.	<ul style="list-style-type: none"> • Diminuer la température programmée sur le régulateur de l'appareil. • Vérifier que la fonction "Marche Forcée (2h)" n'a pas été activée par inadvertance. • S'il chauffe encore, contacter le vendeur ou un professionnel qualifié.
La pièce reste froide.	<ul style="list-style-type: none"> • Vérifier que la puissance de l'appareil est adaptée à la pièce à chauffer. • Lors de première mise en route, il faut environ une paire des heures pour atteindre la température programmée (mettre la régulation au maximum ne fait pas augmenter la température plus vite).
L'appareil ne refroidit pas.	<ul style="list-style-type: none"> • Avec ce type de résistance il faut quelques dizaines de minutes à l'appareil pour refroidir. Attendre le temps nécessaire.
Fuites du liquide contenu dans l'appareil.	<ul style="list-style-type: none"> • Éteindre l'appareil et contacter le revendeur. • Essuyer les fuites en revêtant des gants de protection contre les produits chimiques. Éloigner les enfants et les animaux domestiques du liquide.
L'appareil ne répond pas correctement aux ordres provenant du boîtier Fil Pilote.	<ul style="list-style-type: none"> • Déconnecter l'appareil (mettre l'interrupteur général de l'installation sur la position "0"). S'assurer que le branchement est correct (Fig.8) et que le boîtier fonctionne correctement. • Contacter un professionnel qualifié.
L'appareil continue à chauffer bien que la fenêtre soit ouverte alors que la fonction "Fenêtre Ouverte" est activée.	<ul style="list-style-type: none"> • Quelques minutes peuvent être nécessaires avant que la fonction ne soit active. • Il se peut que la différence entre température extérieure et température intérieure ne soit pas suffisante pour rendre la fonction opérationnelle. • Vérifier que le positionnement de l'appareil est conforme aux prescriptions indiquées au Chap 4.3.2 de cette notice. • Vérifier que l'espace autour du boîtier de commande du radiateur est dégagé. • Si le problème persiste contacter le vendeur ou un professionnel qualifié.
L'appareil ne redémarre pas après la fermeture de la fenêtre alors que la fonction "Fenêtre Ouverte" est activée.	<ul style="list-style-type: none"> • Quelques minutes peuvent être nécessaires avant que le capteur détecte la fermeture de la fenêtre. • Vérifier que l'espace autour du boîtier de commande du radiateur est dégagé. • Désactiver et réactiver la fonction. • Si le délai de réponse de la fonction est excessif, vous pouvez néanmoins remettre le radiateur en marche manuellement. • Si le problème persiste contacter le vendeur ou un professionnel qualifié.
L'écran paraît un message "ALL".	<ul style="list-style-type: none"> • La sonde de température est détériorée. Eteindre l'appareil et contacter votre vendeur.

8. GARANTIE



Il est recommandé de garder tous les éléments de l'emballage en cas de retour de l'appareil au revendeur, l'appareil doit parvenir intact afin de maintenir les conditions de garantie.

Le constructeur garantit à ses clients tous les droits spécifiés dans la directive européenne 1999/44/CE ainsi que les droits des consommateurs reconnus par les législations nationales. La garantie couvre notamment les non-conformités et les défauts de production existant au moment de la vente du produit et constatés avant deux ans à compter de la date d'achat. Elle donne le droit au client d'obtenir la réparation gratuite du produit défectueux ou son remplacement s'il n'est pas réparable.

Les droits susmentionnés sont annulés dans les cas suivants:

- défauts causés par une utilisation autre que celles spécifiées dans cette notice, qui fait partie intégrante du contrat de vente;
- défauts causés par une rupture accidentelle, par négligence ou effraction.

Les opérations relatives à l'installation, au branchement aux installations d'alimentation et à l'entretien cités dans la notice sont exclues de la garantie.

Le fabricant décline toute responsabilité pour les dommages ou blessures provoqués directement ou indirectement aux personnes, biens ou animaux domestiques et dus au non-respect des prescriptions indiquées dans cette notice, en particulier les avertissements concernant l'installation, la mise en service et l'utilisation de l'appareil.

Pour bénéficier des droits susmentionnés, le Client doit contacter son revendeur et présenter une preuve d'achat délivrée par le vendeur et établissant la date d'achat du produit.

9. ÉLIMINATION



S'assurer que le câble d'alimentation est déconnecté de la ligne électrique avant toute opération. Pour le démontage procéder dans le sens inverse de l'installation (Schéma 1).

Lorsque l'appareil de chauffage est mis au rebut, respecter les réglementations concernant l'élimination et la gestion des déchets.



Avertissements pour l'élimination correcte du produit aux termes de la Directive européenne 2012/19/EC.

Au terme de son utilisation, le produit ne doit pas être éliminé avec les déchets urbains.

Le produit doit être remis à l'un des centres de collecte sélective prévus par l'administration communale ou auprès des revendeurs assurant ce service.



Cet appareil est conforme aux Directives européennes:

2014/30/EU sur la compatibilité électromagnétique

2014/35/EU sur la basse tension

2011/65/EU sur la limitation de l'utilisation de certaines substances dangereuses.

CET APPAREIL EST CONFORME À LA DIRECTIVE EUROPÉENNE 2009/125/CE ET AU RÈGLEMENT (UE) 2015/1188 PORTANT APPLICATION DE CETTE DIRECTIVE

Exigences d'informations applicables aux dispositifs de chauffage décentralisés électriques

Référence(s) du modèle: (voir étiquette des caractéristiques sur le produit)

Coordonnées de contact:

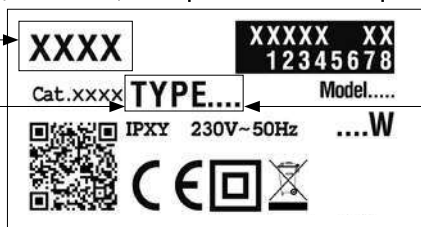

PUISSANCE THERMIQUE	TYPE	VALEUR	UNITÉ
Puissance thermique nominale (P_{nom})	xVExx07x	0,7	kW
	xVExx09x	0,9	
	xVExx10x	1,0	
	xVExx12x	1,2	
	xVExx15x	1,5	
	xVExx18x	1,8	
	xVExx20x	2,0	
Puissance thermique minimale (indicative) (P_{min})	xVExx07x	0,0	kW
	xVExx09x		
	xVExx10x		
	xVExx12x		
	xVExx15x		
	xVExx18x		
	xVExx20x		
Puissance thermique maximale continue ($P_{max,c}$)	xVExx07x	0,7	kW
	xVExx09x	0,9	
	xVExx10x	1,0	
	xVExx12x	1,2	
	xVExx15x	1,5	
	xVExx18x	1,8	
	xVExx20x	2,0	

CONSOMMATION AUXILIAIRE D'ELECTRICITE	TYPE	VALEUR	UNITÉ
À la puissance thermique nominale ($e_{l,max}$)	xVExx07x	0,000	kW
	xVExx09x		
	xVExx10x		
	xVExx12x		
	xVExx15x		
	xVExx18x		
	xVExx20x		
À la puissance thermique minimale ($e_{l,min}$)	xVExx07x	0,000	kW
	xVExx09x		
	xVExx10x		
	xVExx12x		
	xVExx15x		
	xVExx18x		
	xVExx20x		
En mode veille ($e_{l,sp}$)	xVExx07x	0,000	kW
	xVExx09x		
	xVExx10x		
	xVExx12x		
	xVExx15x		
	xVExx18x		
	xVExx20x		

Type de contrôle de la puissance thermique/de la température de la pièce

- contrôle de la puissance thermique à un palier, pas de contrôle de la température de la pièce [NON]
- contrôle à deux ou plusieurs paliers manuels, pas de contrôle de la température de la pièce [NON]
- contrôle de la température de la pièce avec thermostat mécanique [NON]
- contrôle électronique de la température de la pièce [NON]
- contrôle électronique de la température de la pièce et programmeur journalier [NON]
- contrôle électronique de la température de la pièce et programmeur hebdomadaire [OUI]

Autres options de contrôle

- contrôle de la température de la pièce, avec détecteur de présence [NON]
- contrôle de la température de la pièce, avec détecteur de fenêtre ouverte [OUI]
- option contrôle à distance [NON]
- contrôle adaptatif de l'activation [OUI]
- limitation de la durée d'activation [NON]
- capteur à globe noir [NON]

SYMBOLE WYKORZYSTANE W INSTRUKCJI



UWAGA!
ZAGROŻENIE BEZPIECZEŃSTWA OSÓB, ZWIERZĄT
DOMOWYCH I RZECZY.



UWAGA!
NIEBEZPIECZEŃSTWO PORĄŻENIA PRĄDEM.



UWAGA!
NIEBEZPIECZEŃSTWO USZKODZENIA PRODUKTU.



UWAGA!
WYSOKIE TEMPERATURY.
NIEBEZPIECZEŃSTWO OPARZEŃ.



PORADA DLA DOBREGO
FUNKCJONOWANIA.



NIE ZAKRYWAĆ!

UWAGA



OSTRZEŻENIE - Niektóre części produktu mogą stać się bardzo gorące i mogą być przyczyną oparzeń. Należy zachować szczególną ostrożność w obecności dzieci lub osób wrażliwych.



Dzieci poniżej 3 roku życia, jeśli nie są pod nadzorem, muszą znajdować się w odpowiedniej odległości od grzejnika.

Dzieci w wieku między 3 a 8 lat powinny wyłącznie włączać / wyłączać urządzenie, po warunkiem, że jest ono zainstalowane w normalnej pozycji funkcjonowania, a dzieci znajdują się pod nadzorem lub są odpowiednio przygotowane do bezpiecznego użytkowania urządzenia i zrozumiały ryzyko łączące się z jego użytkowaniem.

Dzieci w wieku między 3 a 8 lat mogą nie mogą odłączać urządzenia z prądu, regulować go i czyścić lub wykonywać konserwacji.

Urządzenie może być użytkowane przez dzieci w wieku powyżej 8 lat i przez osoby o ograniczonych zdolnościach psychicznych, fizycznych i ruchowych lub o niewystarczającym doświadczeniu i wiedzy, pod warunkiem, że będą uważnie nadzorowane i pouczone przez osobę, która jest za nie odpowiedzialna, o bezpiecznym użytkowaniu urządzenia i o ryzyku z nim związanym. Należy pilnować, by dzieci nie bawiły się urządzeniem. Czyszczenie i konserwacja wykonywana przez użytkownika nie może być wykonana przez dzieci, bez nadzoru dorosłych.



Nie instalować urządzenia:

- bezpośrednio pod lub przed gniazdkiem elektrycznym lub puszką rozgałęźną (Rys. 5)
- w kontakcie ze ścianą lub posadzką
- w pobliżu zasłon, innych materiałów łatwopalnych, paliw lub pojemników ciśnieniowych



UWAGA:
Przestrzegać odległości wskazanych na rysunkach 3, 4.



Instalować i użytkować urządzenie tylko zgodnie ze wskazaniami niniejszej instrukcji obsługi.



W razie uszkodzenia kabla zasilającego, należy zwrócić się o jego wymianę do producenta, do jego serwisu technicznego lub do innego wykwalifikowanego personelu, aby zapobiec jakiegokolwiek ryzyku. Nie używać urządzenia jeśli urządzenie lub centralka elektroniczna są uszkodzone.



Upewnić się, że linia zasilająca jest wyposażona w urządzenie, które pozwala na odcięcie urządzenia od elektrycznej sieci domowej, łącznie z Przewodem Sterowniczym, jeśli obecny, zgodnie z obowiązującą normą.



UWAGA: aby uniknąć niebezpiecznego przegrzania, nie należy w żadnym wypadku zakrywać urządzenia (Rys.7). Nie zakrywać przepływu powietrza, wkładając do wnętrza materiały.



Przy utylizacji urządzenia, należy przestrzegać obowiązujących przepisów normy w sprawie utylizacji i zarządzania odpadami.

1. CHARAKTERYSTYKI URZĄDZENIA

Napięcie zasilania: 230 V ~ 50 Hz

Klasa izolacji: II 

Stopień ochrony: IPx4

TYPE	Moc [W]	Długość [cm]	Wysokość [cm]	Ciężar [kg]	Prąd znamionowy [A]
CVE0610F	1000	55	58	16	4,5
CVE0915F	1500	79	58	24	6,5
CVE1220F	2000	104	58	32	9
DVE0610F	1000	55	58	11	4,5
DVE0915F	1500	79	58	16	6,5
DVE1118F	1800	95	58	19	8
EVE0610F	1000	55	58	17	4,5
EVE0915F	1500	79	58	25	6,5
EVE1220F	2000	103	58	33	9

Tabela 1



Dane techniczne urządzenia podane są na etykietce charakterystyk, umieszczonej na boku grzejnika (Rys. 1).

A	Marka/Producent	F	Podwójna izolacja
B	Model, typ, kategoria	G	Sposób utylizacji
C	Kod Dwuwymiarowy (QR)	H	Znaki jakości
D	Stopień ochrony	I	Napięcie zasilania i Moc
E	Znakowanie CE	L	Numer serijny

2. INFORMACJE OGÓLNE



Odpakować ostrożnie urządzenie, opierając je na kątownikach ze styropianu lub na dywanie.

Zawartość opakowania jest następująca:

- urządzenie
- zestaw montażowy
- instrukcja obsługi



Przeczytać uważnie i w całości instrukcję obsługi, przed rozpoczęciem instalacji i użytkowania. Przechowywać instrukcję dla konsultacji w przyszłości.



Instalować i użytkować urządzenie tylko zgodnie ze wskazaniami niniejszej instrukcji obsługi.



Instrukcje nie pokrywają wszystkich możliwych sytuacji, które mogą zaistnieć. Należy zawsze kierować się zdrowym rozsądkiem i zachować ostrożność podczas instalacji, funkcjonowania i przechowywania urządzenia.



Zabrania się modyfikacji, w jakikolwiek sposób, charakterystyk urządzenia i usuwania jakiegokolwiek stałej części, łącznie z zatyczkami. Upewnić się, że urządzenie jest całe. Nie używać urządzenia jeśli jest uszkodzone, lecz skontaktować się ze sprzedawcą lub wykwalifikowanym personelem.



Materiały użyte do pakowania nadają się do recyklingu. Dlatego też zaleca się wrzucenie ich do odpowiednich kontenerów, przeznaczonych do segregacji odpadów.

3. POZYCJONOWANIE I INSTALACJA



Urządzenie zostało wyprodukowane w celu ogrzewania pomieszczeń do użytku domowego lub podobnego. Nie może być przeznaczone do innych celów. Urządzenie musi być używane po uprzedniej instalacji na ścianie, jak opisano w niniejszej instrukcji. Zainstalować urządzenie z termostatem w dole (Rys. 2).



W łazience (w której znajduje się wanna lub prysznic), instalować urządzenie poza strefą 1. Instalować urządzenie w taki sposób, by centralka elektroniczna i inne urządzenia sterownicze nie mogły być dotknięte przez osobę znajdującą się w wannie lub pod prysznicem. Zabrania się używania wtyczki w celu podłączenia grzejnika.



Dla grzejników z wtyczką, należy zapoznać się z ostrzeżeniami podanymi na stronie 53.



Przestrzegać odległości wskazanych na rysunkach 3, 4.



Nie instalować urządzenia:

- bezpośrednio pod lub przed gniazdkiem elektrycznym lub puszką rozgałęźną (Rys. 5)
- w kontakcie ze ścianą lub posadzką
- w pobliżu zaston, innych materiałów łatwopalnych, paliw lub pojemników ciśnieniowych



Sprawdzić czy w ścianie, na której chce się zamontować grzejnik, nie znajdują się przewody lub kable elektryczne, które mogłyby zostać uszkodzone podczas instalacji.



Urządzenie wyposażone jest w czujnik będący w stanie wykrywać otwarcie ewentualnego okna, obecnego nad nim. Dla prawidłowego funkcjonowania funkcji "Otwarte Okno", zaleca się sprawdzenie i przestrzeganie wskazań podanych w Rozdz. 4.3.2 przed jego zamontowaniem na ścianie.

3.1 MONTAŻ NA ŚCIANIE



Upewnić się, że śruby i kołki zawarte w opakowaniu, nadają się do typu ściany, na której zostanie zainstalowany grzejnik. W razie jakichkolwiek wątpliwości należy zwrócić się do wykwalifikowanego personelu lub do sprzedawcy.



Śledzić sekwencję instalacji, znajdującą się w składowanej części okładki (Schemat 1), przestrzegając minimalnej odległości między dolną częścią grzejnika a posadzką (Rys. 3).



Podczas instalacji należy upewnić się, że kabel zasilający jest odłączony od linii elektrycznej.

3.2 PODŁĄCZENIE ELEKTRYCZNE



UWAGA

Instalacja musi zostać wykonana przez wyspecjalizowanego technika i zgodnie z normami obowiązującymi w danym kraju.

Kiedy urządzenie zostaje zainstalowane, należy upewnić się, że nie jest zasilane elektrycznie i że główny wyłącznik jest ustawiony na pozycji "0".



Zasilanie urządzenia to 230 V ~ 50 Hz. Upewnić się, że linia elektryczna jest zgodna z danymi zamieszczonymi w tabeli 1.



Upewnić się, że linia zasilająca jest wyposażona w urządzenie, które pozwala na odcięcie urządzenia od elektrycznej sieci domowej, łącznie z Przewodem Sterowniczym, jeśli obecny, zgodnie z obowiązującą normą.

W przypadku instalacji w łazienkach, linia elektryczna musi zostać wyposażona w urządzenie zabezpieczające różnicowoprądowe o dużej wrażliwości z znamionowym różnicowym prądem zadziałania równym 30 mA. Linia zasilająca i centralka Przewodu Sterowniczego muszą być zawsze chronione tym samym wyłącznikiem różnicowoprądowym.

Wykonać podłączenie elektryczne wewnątrz puszkii rozgałęźnej.

W przypadku wilgotnych pomieszczeń (kuchnia łazienka), podłączenie urządzenia do obwodu musi znajdować się przynajmniej 25 cm od posadzki.

Należy rygorystycznie przestrzegać schematu podłączenia elektrycznego, przedstawionego na rysunku 8.



Jeśli Przewód Sterowniczy nie jest podłączony do centralki programowania, musi zostać zizolowany. W żadnym przypadku nie podłączać Przewodu Sterowniczego do uziemienia.



Upewnić się, że kabel zasilający nie może w żaden sposób wejść w kontakt z powierzchnią urządzenia (Rys. 6).

4. REGULACJA I FUNKCJONOWANIE



Urządzenie zostało skonstruowane do ogrzewania otoczenia. Niektóre części produktu mogą stać się bardzo gorące i mogą być przyczyną oparzeń. Należy zachować szczególną ostrożność w obecności dzieci lub osób wrażliwych.



Trzymać paliwa, materiały łatwopalne i zbiorniki ciśnieniowe (na przykład aerozole, gaśnice) przynajmniej 50 cm od urządzenia. Nie rozpylać substancji żadnego typu na powierzchni urządzenia.



Nie dotykać urządzenia wilgotnymi czy mokrymi rękami lub stopami. Nie moczyć centralki elektronicznej wodą lub innymi płynami. W przypadku, gdy dojdzie do zamoczenia, odłączyć zasilanie prądem i pozostawić urządzenie do całkowitego wyschnięcia.



Instalacja urządzenia na dużych wysokościach geograficznych powoduje zwiększenie temperatury ogrzewanego powietrza.



Przy okazji pierwszego włączenia, normalną rzeczą jest, że z urządzenia wydobywać się będzie zapach, który zniknie w krótkim czasie. Zaleca się przewietrzenie pomieszczenia po pierwszym użyciu.



Podczas włączania urządzenia w zimnych pomieszczeniach, może ono wydawać metalowe hałasy, spowodowane rozszerzaniem się materiałów.



W przypadku, gdy na etapie mocowania lub przy okazji pierwszego włączenia, pojawiają się oleiste ślady w dolnej części urządzenia, prawdopodobnie jest to pozostałość obróbki. Wyczyścić daną część, zachowując odpowiednie środki ostrożności, w odstępach kilkudniowych. Jeśli zjawisko utrzymuje się, należy śledzić wskazówki podane w Rozdz. 7.

PL

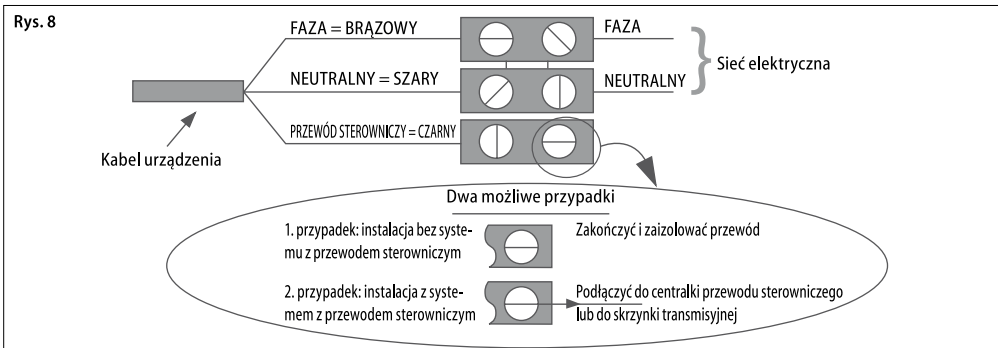

UŻYTKOWANIE GRZEJNIKA Z PANELU STEROWNICZEGO:

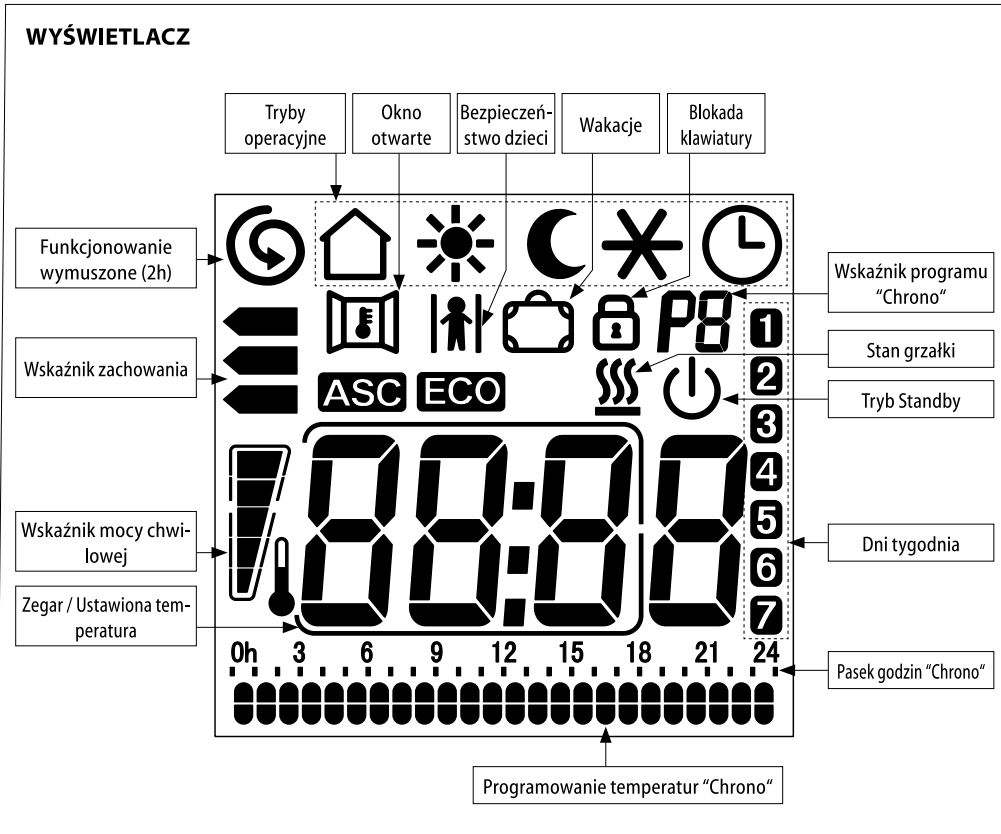
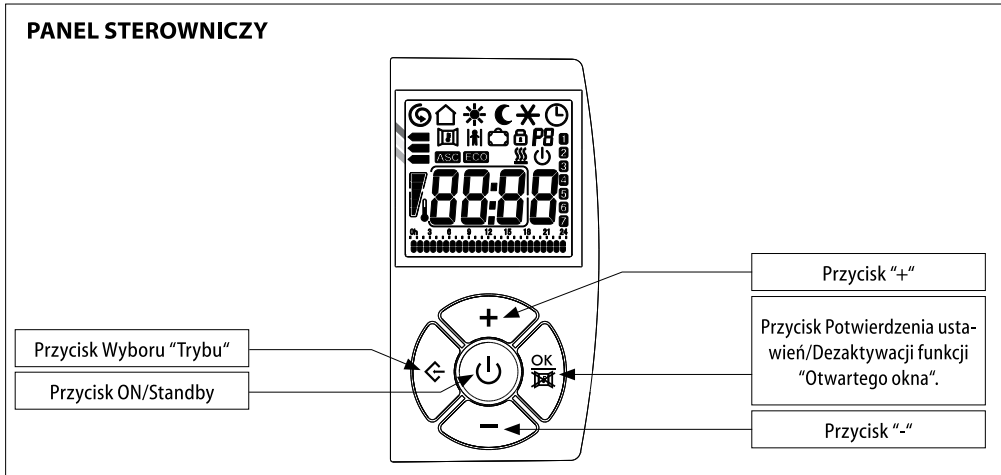

PL

4.1 TRYB ON/STANDBY



W trybie "Standby", wyświetlacz pokazuje ikonę , godzinę i dzień tygodnia.

Wszystkie tryby, łącznie z "przewodem sterowniczym" są nieaktywne, lecz urządzenie pozostaje pod napięciem w oczekiwaniu na otrzymanie polecenia.



Aby włączyć lub wyłączyć urządzenie, należy wcisnąć przycisk "Stanby". Grzejnik włącza się w trybie operacyjnym, wybranym przed wyłączeniem i wydaje sygnał akustyczny.

Wyświetlacz pokaże godzinę trybu "Chrono", podczas gdy w innych trybach pokazuje ustawioną temperaturę.







Urządzenie ostrzega, podwójnym sygnałem akustycznym, wejście w tryb "Standby" i przedłużonym sygnałem akustycznym, wyjście z trybu.

4.2 TRYBY OPERACYJNE

Urządzenie oddaje do dyspozycji 6 trybów operacyjnych, które pozwalają na ogrzewanie otoczenia w sposób najbardziej odpowiadający potrzebom użytkownika.



Wcisnąć przycisk "Tryb", aby wybrać żądany tryb operacyjny. Ikona na wyświetlaczu pokazuje tryb operacyjny:

	Przewód sterujący		Comfort
	Noc/Eco		Przeciw zamarzaniu
	"Chrono"		Energy Saving



PRZEWÓD STERUJĄCY

Temperatura programowana jest przy użyciu poleceń "Przewodu sterowniczego".

Wszystkie polecenia "Przewodu sterowniczego" są aktywne.



COMFORT

Temperatura w trybie "Comfort" odpowiada temperaturze żądanej przez klienta.

Wszystkie polecenia "Przewodu sterowniczego" są dezaktywowane.



NOC/ECO

Tryb "Noc/Eco" utrzymuje komfortową temperaturę przy ograniczonym zużyciu energii.

Wszystkie polecenia "Przewodu sterowniczego" są dezaktywowane.



PRZECIW ZAMARZANIU

W trybie "Przeciw zamarzaniu" minimalna temperatura ustawiona jest na 7 °C.

Urządzenie włącza się automatycznie, gdy tempe-

ratura otoczenia spada poniżej 7 °C.

Wszystkie polecenia "Przewodu sterowniczego" są dezaktywowane.



"CHRONO"

Tryb ten" pozwala na wybór jednego z trzech, wstępnie ustawionych programów czasowych lub też programu dostosowanego indywidualnie. Ten ostatni umożliwia programowanie dzienne i tygodniowe, z dwoma poziomami temperatury (tryb "Comfort" i "Noc/Eco"). Wszystkie polecenia "Przewodu sterowniczego" są dezaktywowane.



ENERGY SAVING

Tryb ten pozwala na zmniejszenie zużycia energii, w przypadku, gdy pomieszczenie pozostaje puste. Temperatura ustawiona jest na 17 °C.

Wszystkie polecenia "Przewodu sterowniczego" są dezaktywowane.

Kiedy na wyświetlaczu pokazana jest ikona , aktywna jest grzałka.

4.2.1 PRZEWÓD STERUJĄCY

Aby aktywować tryb "Przewodu sterowniczego":







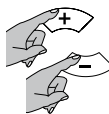

Wcisnąć i trzymać wciśnięty przycisk "Tryb" do momentu, gdy na wyświetlaczu pojawi się ikona .

Użytkownik może regulować tylko temperaturę w trybie "Comfort" urządzenia.



Wybrać żądaną temperaturę przy użyciu przycisków "+" i "-".

Mieszkanie musi być wyposażone w system zarządzania, który obsługuje tego typu technologię. W tym przypadku, aby sprawdzić prawidłowe przekazywanie poleceń programowania, można użyć następującego schematu, w zależności od ustawionego trybu:

Tryb	Comfort	Noc/Eco (Comfort -3,5 °C)	Przeciw zamarzaniu	Standby	Comfort -1 °C	Comfort -2 °C
Sygnal do przekazania						
Napięcie między przewodem sterowniczym a neutralnym	0 volt	230 volt	115 volt ujemne	115 volt dodatnie	230 volt przez okres 3 s	230 volt przez okres 7 s

Ikona wybranego z centralki trybu (Standby, Comfort, Noc/Eco, Przeciw Zamarzaniu) pojawia się na wyświetlaczu obok ikony .

Jeśli Przewód sterowniczy nie jest podłączony, zostaje automatycznie wybrany tryb "Comfort".

4.2.2 COMFORT ✱

Temperatura w trybie "Comfort" odpowiada temperaturze żądanej przez użytkownika.



Wcisnąć i trzymać wciśnięty przycisk "Tryb" do momentu, gdy na wyświetlaczu pojawi się ikona ✱



Wybrać żądaną temperaturę przy użyciu przycisków "+" i "-".



Zakres regulacji temperatury wynosi od 7 °C do 32 °C.

4.2.3 NOC/ECO

W trybie "Noc/Eco" ustawiona temperatura musi być równa lub niższa od temperatury w trybie "Comfort". Jeśli próbuje się ustawić temperaturę w trybie "Comfort" niższą niż w trybie "Noc/Eco", ta ostatnia zostanie zmieniona.



Wcisnąć i trzymać wciśnięty przycisk "Tryb" do momentu, gdy na wyświetlaczu pojawi się ikona 

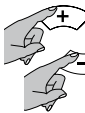

Wybrać żądaną temperaturę przy użyciu przycisków "+" i "-".

Tryb ten zalecany jest w godzinach nocnych i w przypadku, gdy pomieszczenie pozostaje puste przez 2 lub więcej godzin.

4.2.4 PRZECIW ZAMARZANIU ✱

W trybie "Przeciw zamarzaniu", stała temperatura wynosi 7 °C. Urządzenie uruchamia się automatycznie, gdy temperatura schodzi poniżej 7 °C i, przy minimalnym zużyciu energii, zapobiega osiągnięciu w pomieszczeniu temperatury zamarzania.



Wcisnąć i trzymać wciśnięty przycisk "Tryb" do momentu, gdy na wyświetlaczu pojawi się ikona ✱

Tryb ten zalecany jest w przypadku, gdy pomieszczenie pozostaje puste przez jeden lub kilka dni.

4.2.5 CHRONO

Tryb "Chrono" pozwala użytkownikowi na wybór jednego z trzech, wstępnie ustawionych programów czasowych lub też programu dostosowanego indywidualnie. Ten ostatni pozwala na ustawienie różnych temperatur ("Comfort" i "Noc/Eco") w ciągu 24 godzin, dla każdego dnia tygodnia.

WYBÓR PROGRAMU



Wcisnąć i trzymać wciśnięty przycisk "Tryb" do momentu, gdy na wyświetlaczu pojawi się ikona . Następnie wcisnąć jednocześnie przyciski "Tryb" i "-", trzymając je oba wciśnięte przez przynajmniej 3 sekundy.

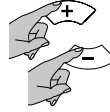

Numer wskazujący program (P1, P2, P3 i P4) zaczyna migać: wcisnąć przyciski "+" i "-", w celu ustawienia żądanego programu. Wcisnąć przycisk "Tryb", aby potwierdzić.

W tym momencie zaczyna migać ikona funkcji ASC (zobacz rozdz. 4.3.1), wcisnąć przycisk , aby aktywować funkcję lub przycisk "-" aby ją dezaktywować.

PROGRAM P1	GODZINY	TRYB
OD PONIEDZIAŁKU DO PIĄTKU	0 - 6	Noc/Eco
	6 - 9	Comfort
	9 - 16	Noc/Eco
	16 - 23	Comfort
	23 - 0	Noc/Eco
SOBOTA I NIEDZIELA	0 - 7	Noc/Eco
	7 - 23	Comfort
	23 - 0	Noc/Eco

PROGRAM P2	GODZINY	TRYB
OD PONIEDZIAŁKU DO NIEDZIELI	0 - 7	Noc/Eco
	7 - 23	Comfort
	23 - 0	Noc/Eco

PROGRAM P3	GODZINY	TRYB
OD PONIEDZIAŁKU DO PIĄTKU	0 - 6	Noc/Eco
	6 - 9	Comfort
	9 - 13	Noc/Eco
	13 - 23	Comfort
	23 - 0	Noc/Eco
SOBOTA I NIEDZIELA	0 - 7	Noc/Eco
	7 - 23	Comfort
	23 - 0	Noc/Eco

PROGRAM P4 - DOSTOSOWANY INDYWIDUALNIE

Program "P4" pozwala użytkownikowi na ustawienie różnych temperatur ("Comfort" i "Noc/Eco") w ciągu 24 godzin, dla każdego dnia tygodnia.

REGULACJA DATY I GODZINY

Przed przystąpieniem do ustawienia programu dostosowanego indywidualnie P4, należy sprawdzić czy godzina i dzień tygodnia są prawidłowe.



Jeśli tak nie jest, należy wcisnąć i trzymać wciśnięty przycisk "Tryb" do momentu, gdy na wyświetlaczu pojawi się ikona ☺.

Następnie należy ponownie wcisnąć przycisk "Tryb" i trzymać wciśnięty do momentu, gdy numer wskazujący dzień zaczyna migać.

1
2
3

Wcisnąć przyciski "+" i "-" aby ustawić prawidłowy dzień tygodnia (1=PON, 2=WT,... 7=NIEDZ). Wcisnąć przycisk "Tryb", aby potwierdzić.

20:30

Powtórzyć tę samą procedurę dla regulacji godziny.

20:30

W tym momencie zaczynają migać minuty, użyć przycisków "+" i "-", aby je ustawić i wcisnąć przycisk , aby potwierdzić i wyjść lub przycisk "Tryb", by wejść do ustawień programu P4.

USTAWIENIE PROGRAMU P4

Aby wejść do ustawień programu dostosowanego indywidualnie P4, należy wcisnąć przycisk "TRYB", po zakończeniu regulacji minut (zobacz REGULACJA GODZINY).

Zaczynając od pierwszego dnia, wybrać żądaną sekwencję godzin, przy użyciu przycisków "+" i "-", wybierając dla każdej godziny, między temperaturą w trybie "Comfort" (podwójne nacięcie) a temperaturą w trybie "Noc/Eco" (pojedyncze nacięcie).

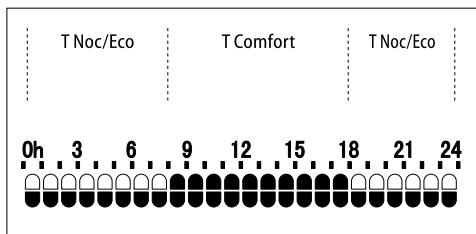

Wcisnąć przycisk "Tryb", by potwierdzić i powtórzyć tę samą procedurę dla każdego dnia tygodnia.

Programowanie tygodniowe zostało ustawione.

W tym momencie zaczyna migać ikona funkcji ASC (zobacz rozdz. 4.3.1), wcisnąć przycisk , aby aktywować funkcję lub przycisk "-" aby ją dezaktywować.

4.2.6 ENERGY SAVING

W ten sposób temperatura ustawiona jest na 17 °C. Funkcja "Energy Saving" pozwala na zmniejszenie zużycia, w przypadku, gdy pomieszczenie pozostaje puste, lecz chce się utrzymać komfortową temperaturę.



Aby aktywować "Energy Saving", należy wcisnąć przycisk "Tryb" do momentu, gdy pojawi się na wyświetlaczu napis "ES", zastępując godzinę/temperaturę.

4.3 FUNKCJONUJE

Urządzenie wyposażone jest w specjalne funkcje, które pozwalają na indywidualne dostosowanie i optymalizację użytkownika urządzenia.

4.3.1 ASC

Funkcja wykrywa inercję w pomieszczeniu, by osiągnąć ustaloną temperaturę i wyprzedza włączenie grzejnika, by zapewnić osiągnięcie temperatury "Comfort" o ustawionej godzinie. Funkcja ta może wyprzedzić włączenie urządzenia o maksymalnie 2 godziny.



Funkcja ta może być aktywowana i operatywna tylko w trybie "Chrono". (zobacz Rozdz. 4.2.5)





Dla optymalnego funkcjonowania ASC koniecznych jest kilka dni dla nabycia danych.

4.3.2 OKNO OTWARTE

Funkcja "Otwarte Okno" pozwala urządzeniowi na autonomiczne wykrywanie ewentualnego otwarcia okna w pobliżu grzejnika (na przykład podczas sprzątania domu) i na ustawianie się w trybie "Przeciw Zamarzaniu", w celu zapobiegania niepotrzebnemu ogrzewaniu i unikania strat energii. W ten sam sposób, funkcja wykrywa zamknięcie okna i przywraca poprzednio ustawiony tryb operacyjny.

Przy włączeniu urządzenia, funkcja jest już aktywna, w oczekiwaniu na wykrycie ewentualnego otwarcia okna.



Aby aktywować lub dezaktywować funkcję, należy wcisnąć przycisk  i trzymać wciśnięty do momentu, gdy na wyświetlaczu pojawi się lub zniknie ikona .

Kiedy zostaje wykryte otwarcie okna, ikona "Otwarte Okna" zaczyna migać.

W tym momencie można anulować funkcję, poprzez wciśnięcie przycisku , do momentu wykrycia kolejnego otwarcia.

Ikona  przestaje migać.



Aby zagwarantować optymalne działanie funkcji, zaleca się instalację urządzenia w pobliżu okna (Rys. 9).

Rys. 9

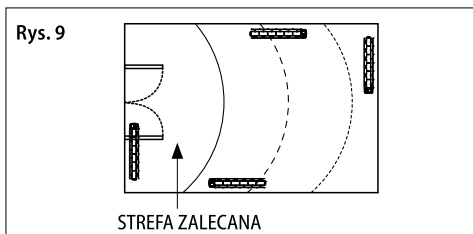

Odpowiedź urządzenia na otwarcie i zamknięcie okna zależy od wielu czynników, takich jak temperatura ustawiona na urządzeniu, temperatura na zewnątrz, stopień wentylacji pomieszczenia, w którym zainstalowany jest grzejnik, pozycja grzejnika w pomieszczeniu, obecność innych źródeł ciepła.



Funkcja "Otwarte Okno" nie jest aktywowana lub dezaktywowana w trybie "Standby".



Jeśli urządzenie wykryło otwarcie okna, wszystkie tryby i funkcja "Wymuszonego Funkcjonowania (2h)" mogą zostać wybrane, lecz nie są aktywne do momentu zamknięcia okna lub anulowania funkcji "Otwartego Okna". Funkcje "Bezpieczeństwo Dzieci" i "Blokada Klawiatury" pozostają aktywne i są aktywowane lub dezaktywowane, również wtedy, gdy urządzenie wykryło otwarcie okna.

Również przy tej funkcji dzieci muszą być nadzorowane, by nie zdarzały się niebezpieczne sytuacje.



Należy w każdym razie unikać jakiegokolwiek, przedłużonego kontaktu części ciała z urządzeniem.

Jeśli urządzenie już funkcjonuje lub jest jeszcze gorące po niedawnym użytkowaniu, gdy aktywuje się funkcję "Bezpieczeństwo Dzieci", konieczne są przynajmniej dwie godziny, by temperatura zeszała do zmniejszonej wartości i funkcja stała się aktywna.

4.3.4 FUNKCJONOWANIE WYMUSZONE (2H)

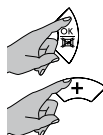
Funkcja "Wymuszone funkcjonowanie (2h)" służy do szybszego ogrzewania pomieszczenia.



Aby aktywować funkcję, należy wcisnąć jednocześnie przyciski  i "+", trzymając je wciśnięte do momentu pojawienia się na wyświetlaczu symbolu .

Minuty brakujące do zakończenia dwóch godzin, pokazane są na wyświetlaczu.

Urządzenie ogrzewa przez dwie godziny na pełnej mocy, ignorując poprzednie ustawienie temperatury.

Aby dezaktywować funkcję "Wymuszonego funkcjonowania (2h)", należy jednocześnie wcisnąć dwa przyciski, jak poprzednio. Po dwóch godzinach od aktywacji, funkcja "Wymuszone funkcjonowanie (2h)" dezaktywuje się automatycznie, a urządzenie powraca do poprzednio wybranego trybu.



Funkcja "Bezpieczeństwa Dzieci" ogranicza moc grzejnika również w funkcji "Wymuszonego Funkcjonowania (2h)".



Jeśli urządzenie wykryło otwarcie okna, funkcja "Wymuszonego Funkcjonowania (2h)" nie może być aktywowana do momentu zamknięcia okna lub anulowania funkcji "Otwartego Okna" (zobacz Rozdz. 4.3.2), podczas gdy odliczanie kontynuuje, po upływie dwóch godzin .

4.3.3 BEZPIECZEŃSTWO DZIECI

Po aktywacji funkcji "Bezpieczeństwo Dzieci", temperatura powierzchni urządzenia zostaje zmniejszona w stosunku do normalnego funkcjonowania aktywnego trybu ("Comfort", "Noc/Eco",...), tak by zmniejszyć ryzyko oparzeń, w razie przypadkowego i krótkiego kontaktu.

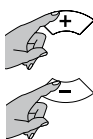

Aby aktywować funkcję, należy wcisnąć jednocześnie przyciski "+" i "-", trzymając je wciśnięte do momentu pojawienia się na wyświetlaczu ikony .

Aby dezaktywować funkcję, należy powtórzyć tę sam



Funkcja "Bezpieczeństwo Dzieci" jest aktywowana w każdym trybie operacyjnym i również w funkcji "Wymuszonego Funkcjonowania (2h)". Funkcja nie może być aktywowana, jeśli urządzenie znajduje się w "Standby".

WAŻNE UWAGI:

W funkcji tej, energia termiczna, uwolniona przez urządzenie, zostaje zmniejszana i dlatego też konieczny jest dłuższy czas dla ogrzania pomieszczeń.

4.3.5 WAKACJE

W przypadku, gdy opuszcza się mieszkanie na określoną liczbę dni, można ustawić grzejnik w trybie "Przeciw Zamarzaniu", na cały okres nieobecności, po którym to grzejnik powraca do normalnego trybu funkcjonowania.

Aby aktywować funkcję, należy wcisnąć jednocześnie przyciski  i "+", trzymając je wciśnięte do momentu pojawienia się na wyświetlaczu ikony .

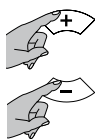

Użyć przycisków "+" i "-", by ustawić liczbę dni (maksymalnie 45 dni).

Żądane ustawienie zostaje potwierdzone automatycznie.

W tym momencie na wyświetlaczu pojawia się ikona  i liczba ustawionych dni, która zmniejsza się progresywnie, wraz z upływem dni.

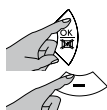

Aby dezaktywować, w jakimkolwiek momencie funkcję, należy wcisnąć jednocześnie przyciski  i "-".

4.3.6 BLOKADA KLAWIATURY

Można zablokować klawiaturę sterowniczą, by uniknąć przypadkowych modyfikacji funkcjonowania.

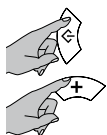

Aby aktywować funkcję, należy wcisnąć jednocześnie przyciski "Tryb" i "+", trzymając je wciśnięte do momentu pojawienia się na wyświetlaczu ikony .

Aby odblokować klawiaturę, należy wcisnąć jednocześnie dwa przyciski, jak opisano poprzednio. Ikona "Blokady klawiatury" zniknie z wyświetlacza.

WAŻNE: Funkcja "Blokada Klawiatury" nie blokuje przycisku "Standby", który jest zawsze aktywny, również gdy funkcja "Blokada Klawiatury" jest aktywna.

4.4 WSKAŹNIK ZACHOWANIA

Wskaźnik zachowania pozwala na kontrolę, czy ustawiona temperatura zgadza się z tymi zalecanymi, w celu uniknięcia strat i zmniejszenia zużycia energii.

Strzałka ustawi się przy jednym z trzech kolorowych pasków, które przedstawiają jakościowo, zużycie energii, zgodnie z następującym schematem:



(a) **Zielona:** Wybrana temperatura jest już niższa od tej zalecanej.

(b) **Żółta:** Temperatura jest odpowiednia, się lecz zaleca się obniżyć ją lekko.

(c) **Czerwona:** Wybrana temperatura jest wysoka, dobrze byłoby ją obniżyć.

UWAGA: wskaźnik dostarcza tylko jakościowych wskazań, dotyczących zużycia energii, a nie pomiarów absolutnych.

4.5 WSKAŹNIK MOCY CHWILOWEJ

Wykres ten pokazuje chwilowe przedstawienie wykorzystywania mocy grzejnika (każdy sektor przedstawia 20% mocy).

WAŻNE: W przypadku braku zasilania, wszystkie aktualne ustawienia pozostają utrzymane, tracąc jednak ustawienie daty i godziny.

Jeśli brak zasilania następuje przy aktywnym trybie "Chrono", po przywróceniu działania grzejnika, zostaje aktywowany tryb "Energy Saving".

WAŻNE: W przypadku braku zasilania przy aktywnej funkcji "Wymuszonego Funkcjonowania (2h)", po przywróceniu zasilania, ustawienie daty i godziny zostaje stracone, a urządzenie wychodzi z funkcji, ustawiając się w poprzednio wybranym trybie operacyjnym.

WAŻNE: W przypadku braku zasilania przy aktywnej funkcji "Wakacje", funkcja ta będzie aktywna przy ponownym włączeniu i zacznie kontynuować odliczanie brakujących dni, od momentu przerwania zasilania.

WAŻNE: W przypadku braku zasilania przy aktywnej funkcji "ASC", funkcja ta będzie aktywna przy ponownym włączeniu i będzie potrzebowała kilku dni, by powrócić w pełni operacyjna.

5. CZYSZCZENIE



Przed każdą czynnością czyszczenia należy upewnić się, że urządzenie jest wyłączone, zimne i odłączone elektrycznie.



W celu czyszczenia wystarczy użyć wilgotnej i miękkiej szmatki z neutralnym środkiem czyszczącym. Nie używać ciernych, korozyjnych środków czyszczących lub rozpuszczalników.



Aby utrzymać wydajność urządzenia, należy usuwać pył z jego powierzchni i wnętrza, przynajmniej dwa razy w roku, przy użyciu odkurzacza.

6. KONSERWACJA



W przypadku problemów technicznych należy zwrócić się do wykwalifikowanego personelu (uznanego i autoryzowanego przez sprzedawcę lub producenta) lub skontaktować się ze sprzedawcą.



Jakiegolwiek typ interwencji na urządzeniu musi zostać wykonany przez wykwalifikowany personel, który przed wykonaniem jakiegokolwiek czynności konserwacji, musi upewnić się, że urządzenie jest wyłączone, zimne i odłączone elektrycznie.

7. PROBLEMY I ROZWIĄZANIA

Urządzenie nie grzeje.	<ul style="list-style-type: none"> • Sprawdzić czy włączone jest zasilanie elektryczne i czy urządzenie jest podłączone w prawidłowy sposób. • Sprawdzić pozycję głównego wyłącznika. • Zwiększyć temperaturę ustawioną na regulatorze temperatury urządzenia. • Ze względu na typ grzałki, urządzenie staje się gorące po kilkudziesięciu minutach. Odczekać niezbędny czas. • Zainterweniowało urządzenie zabezpieczające. Wyeliminować przyczynę przegrzania (na przykład zatory, zakrycie)  • Odłączyć połączenie elektryczne urządzenia przez kilka minut, w celu zresetowania systemu elektronicznego. • Jeśli urządzenie w dalszym ciągu nie grzeje, należy skontaktować się ze sprzedawcą lub wykwalifikowanym personelem.
Urządzenie grzeje bez przerwy.	<ul style="list-style-type: none"> • Zmniejszyć temperaturę ustawioną na regulatorze temperatury urządzenia. • Sprawdzić czy uruchomiło się przez przypadek funkcji "Wymuszone funkcjonowanie (2h)". • Jeśli urządzenie w dalszym ciągu grzeje, należy skontaktować się ze sprzedawcą lub wykwalifikowanym personelem.
Pomieszczenie pozostaje zimne.	<ul style="list-style-type: none"> • Sprawdzić czy moc urządzenia jest odpowiednia do potrzeb pomieszczenia do ogrzania. • W przypadku pierwszego uruchomienia, pomieszczenie wymaga kilku godzin dla osiągnięcia żądanej temperatury (ustawić temperaturę na maksymalną wartość, by jak najszybciej zwiększyć temperaturę).
Urządzenie nie ochładza się.	<ul style="list-style-type: none"> • Ze względu na typ grzałki, urządzenie staje się zimne po kilkudziesięciu minutach. Odczekać niezbędny czas.
Wyłączyć urządzenie i skontaktować się ze sprzedawcą.	<ul style="list-style-type: none"> • Wyłączyć urządzenie i skontaktować się ze sprzedawcą. • Osuszyć wycieki, używając rękawic ochronnych, przed produktami chemicznymi. Trzymać dzieci i zwierzęta domowe z dala od płynu.
Urządzenie nie odpowiada prawidłowo na polecenia pochodzące z centralki przewodu sterowniczego.	<ul style="list-style-type: none"> • Odłączyć elektrycznie urządzenie (ustawić główny wyłącznik urządzenia w pozycji "0"). Upewnić się, że podłączenie zostało wykonane zgodnie z niniejszą instrukcją (Rys. 8) i że centralka funkcjonuje prawidłowo. • Skontaktować się z wykwalifikowanym personelem.
Urządzenie kontynuuje ogrzewanie, pomimo otwartego okna i aktywnej funkcji "Otwartego Okna".	<ul style="list-style-type: none"> • Może okazać się konieczne odczekanie kilku minut, zanim funkcja stanie się aktywna. • Może się okazać, że różnica między temperaturą zewnętrzną a wewnętrzną nie jest wystarczająca, by uruchomić tę funkcję. • Sprawdzić czy pozycjonowanie urządzenia jest zgodne z przepisami podanymi w rozdziale 4.3.2 niniejszej instrukcji. • Należy sprawdzić czy miejsce wokół panelu sterowniczego grzejnika jest wolne od wszelkich przeszkód. • Jeśli problem nie znika, należy skontaktować się ze sprzedawcą lub wykwalifikowanym personelem.
Urządzenie nie powraca do ogrzewania po zamknięciu okna, podczas gdy funkcja "Otwartego Okna" jest aktywna.	<ul style="list-style-type: none"> • Może okazać się konieczne odczekanie kilku minut, zanim czujnik wykryje zamknięcie okna. • Należy sprawdzić czy miejsce wokół panelu sterowniczego grzejnika jest wolne od wszelkich przeszkód. • Dezaktywować i ponownie aktywować funkcję. • Jeśli czas odpowiedzi funkcji okaże się nadmierny, można zawsze włączyć grzejnik ręcznie. • Jeśli problem nie znika, należy skontaktować się ze sprzedawcą lub wykwalifikowanym personelem.
Na wyświetlaczu pojawia się komunikat "ALL".	<ul style="list-style-type: none"> • Sonda temperatury jest uszkodzona. Wyłączyć urządzenie i skontaktować się z waszym sprzedawcą.

8. GWARANCJA



Zaleca się zachowanie opakowania, we wszystkich swoich częściach, dla ewentualnego oddania urządzenia sprzedawcy, urządzenie musi zostać zwrócone w całości, w celu zachowania warunków gwarancji.

Producent gwarantuje swym klientom wszystkie prawa zawarte w dyrektywie europejskiej 1999/44/WE oraz prawa konsumentów przyznane w legislacji krajowej.

Gwarancja pokrywa każdą niezgodność i wadę produkcyjną wykrytą w produkcie w momencie sprzedaży, która zostaje wykryta w ciągu dwóch lat od zakupu i daje prawo klientowi do uzyskania bezpłatnej naprawy wadliwego produktu lub jego wymiany, gdy naprawa nie jest możliwa.

Wyżej wymienione prawa przestają obowiązywać w następujących przypadkach:

- wady spowodowane użytkowaniem innym od tego opisanego w niniejszej instrukcji, która stanowi integralną część umowy kupna sprzedaży;
- wady powstałe w wyniku przypadkowego uszkodzenia, zaniedbania lub modyfikacji produktu.

Czynności instalacji, przyłączenia do zasilania i konserwacji, cytowane w niniejszej instrukcji, nie wchodzą w zakres czynności objętych gwarancją.

Producent zrzeka się wszelkiej odpowiedzialności za uszkodzenia lub obrażenia spowodowane bezpośrednio lub pośrednio wobec osób, zwierząt domowych lub rzeczy, w wyniku braku przestrzegania przepisów niniejszej instrukcji, ze szczególnym odniesieniem do ostrzeżeń dotyczących instalacji i uruchomienia produktu.

Aby móc skorzystać z przysługujących mu praw, opisanych powyżej, Klient musi skontaktować się ze sprzedawcą i przedstawić ważny dowód sprzedaży, wystawiony przez sprzedawcę, na którym widnieje data zakupu produktu.

9. UTYLIZACJA



Przed wykonaniem jakiegokolwiek operacji, należy upewnić się, że kabel zasilający jest odłączony od linii elektrycznej. W celu demontażu należy śledzić w odwrotnej kolejności etapy mocowania na ścianie (Schemat 1).

Przy utylizacji urządzenia, należy przestrzegać obowiązujących przepisów normy w sprawie utylizacji i zarządzania odpadami.



Ostrzeżenia dotyczące prawidłowej utylizacji produktu, zgodnie z Dyrektywą Europejską 2012/19/WE.

Po zakończeniu okresu eksploatacyjnego, produkt nie może być utylizowany z odpadami domowymi.

Może zostać oddany do odpowiednich ośrodków zbiórki odpadów, przewidzianych przez administrację lub do sprzedawców, którzy odbierają zużyty sprzęt.



Urządzenie jest zgodne z następującymi dyrektywami europejskimi:

2014/30/UE w sprawie kompatybilności elektromagnetycznej

2014/35/UE niskonapięciowa

2011/65/UE w sprawie ograniczenia stosowania niektórych niebezpiecznych substancji w sprzęcie elektrycznym i elektronicznym



PODŁĄCZENIE ELEKTRYCZNE Z WTYCZKĄ UWAŻNIE PRZECZYTAĆ

Przed włożeniem wtyczki do gniazdka należy dokładnie sprawdzić czy napięcie waszej sieci domowej odpowiada wartości w V, podanej na tabliczce znamionowej urządzenia i czy gniazdko i linia zasilająca są prawidłowo zwymiarowane w stosunku do mocy urządzenia (również wskazanej na tabliczce znamionowej).

Upewnić się, że linia zasilająca wyposażona jest w urządzenie, które pozwala na odcięcie urządzenia od sieci domowej, zgodnie z obowiązującą normą.

Linia elektryczna musi być obowiązkowo wyposażona w urządzenie zabezpieczające różnicowoprądowe o dużej wrażliwości z znamionowym różnicowym prądem zadziałania równym 30 mA.

Wszystkie odniesienia obecne w instrukcji, dotyczące użycia trybu "Przewodu sterowniczego" (Fil Pilote) i jego podłączeń, należy zignorować, gdyż urządzenie nie posiada tego trybu funkcji.

Wymogi w zakresie informacji dotyczące elektrycznych miejscowych ogrzewaczy pomieszczeń

Identyfikator(-y) modelu: (zobacz etykietę charakterystyki na produkcie)

Dane
teleadresowe:

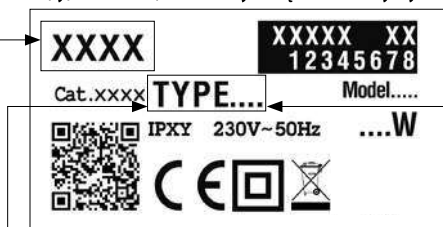

MOC CIEPLNA	TYP	WARTOŚĆ	JEDNOSTKA
Nominalna moc cieplna (P_{nom})	xVExx07x	0,7	kW
	xVExx09x	0,9	
	xVExx10x	1,0	
	xVExx12x	1,2	
	xVExx15x	1,5	
	xVExx18x	1,8	
	xVExx20x	2,0	
Minimalna moc cieplna (orientacyjna) (P_{min})	xVExx07x	0,0	kW
	xVExx09x		
	xVExx10x		
	xVExx12x		
	xVExx15x		
	xVExx18x		
	xVExx20x		
Maksymalna stała moc cieplna ($P_{max,c}$)	xVExx07x	0,7	kW
	xVExx09x	0,9	
	xVExx10x	1,0	
	xVExx12x	1,2	
	xVExx15x	1,5	
	xVExx18x	1,8	
	xVExx20x	2,0	

ZUŻYCIĘ POMOCNICZE ELEKTRYCZNOŚCI	TYP	WARTOŚĆ	JEDNOSTKA
Przy nominalnej mocy cieplnej ($e_{l,max}$)	xVExx07x	0,000	kW
	xVExx09x		
	xVExx10x		
	xVExx12x		
	xVExx15x		
	xVExx18x		
	xVExx20x		
Przy minimalnej mocy cieplnej ($e_{l,min}$)	xVExx07x	0,000	kW
	xVExx09x		
	xVExx10x		
	xVExx12x		
	xVExx15x		
	xVExx18x		
	xVExx20x		
W trybie czuwania ($e_{l,SB}$)	xVExx07x	0,000	kW
	xVExx09x		
	xVExx10x		
	xVExx12x		
	xVExx15x		
	xVExx18x		
	xVExx20x		

Rodzaj mocy cieplnej/regulacja temperatury w pomieszczeniu

- jednostopniowa moc cieplna, bez regulacji temperatury w pomieszczeniu [NIE]
- co najmniej dwa ręczne stopnie bez regulacji temperatury w pomieszczeniu [NIE]
- mechaniczna regulacja temperatury w pomieszczeniu za pomocą termostatu [NIE]
- elektryczna regulacja temperatury w pomieszczeniu [NIE]
- elektryczna regulacja temperatury w pomieszczeniu ze sterownikiem dobowym [NIE]
- elektryczna regulacja temperatury w pomieszczeniu i sterownik tygodniowy [TAK]

Inne opcje regulacji

- regulacja temperatury w pomieszczeniu z wykrywaniem obecności [NIE]
- regulacja temperatury w pomieszczeniu z wykrywaniem otwartego okna [TAK]
- z regulacją na odległość [NIE]
- z adaptacyjną regulacją startu [TAK]
- z ograniczeniem czasu pracy [NIE]
- z czujnikiem ciepła promieniowania [NIE]

SIMBOLOGIE UTILIZATĂ ÎN MANUAL



ATENȚIE!
PERICOL PENTRU SIGURANȚA PERSOANELOR,
ANIMALELOR DOMESTICE ȘI BUNURILOR MATERIALE.



ATENȚIE!
PERICOL DE ELECTROCUTARE.



ATENȚIE!
PERICOL DE DETERIORARE A PRODUSULUI.



ATENȚIE!
TEMPERATURI RIDICATE.
PERICOL DE ARSURI.



RECOMANDARE PENTRU BUNA
FUNCȚIONARE.



NU ACOPERIȚI!

ATENȚIE



AVERTISMENT - Unele părți ale acestui produs pot deveni foarte calde și pot cauza arsuri. Trebuie să se acorde o atenție deosebită când sunt prezenți copii sau persoane vulnerabile.



Copiii cu o vârstă mai mică de 3 ani nu trebuie să li se permită să fie în apropierea caloriferului dacă nu sunt supravegheați.

Copiii cu vârsta cuprinsă între 3 și 8 ani ar trebui să aibă acces doar la funcțiile de pornire/oprire ale aparatului, cu condiția ca acesta să fie instalat în poziția sa de funcționare normală și ca aceștia să fie supravegheați sau instruiți în mod corespunzător cu privire la utilizarea aparatului în condiții de siguranță și să fi înțeles riscurile asociate cu utilizarea acestuia.

Copiii cu vârsta cuprinsă între 3 și 8 ani nu trebuie să deconecteze, să regleze, să curețe aparatul sau să efectueze întreținerea acestuia.

Aparatul poate fi utilizat de copii în vârstă de minimum 8 ani și de persoane cu capacități fizice, senzoriale sau mentale reduse sau care nu dețin experiența ori cunoștințele necesare doar sub supraveghere sau după ce li s-au furnizat instrucțiuni corespunzătoare cu privire la utilizarea sigură a aparatului și la înțelegerea pericolelor presupuse de acesta. Copiii nu trebuie să se joace cu aparatul. Curățarea și întreținerea care trebuie să fie efectuate de către utilizator nu trebuie să se lase în seama copiilor nesupravegheați.



Nu instalați aparatul:

- imediat dedesubtul sau în fața unei prize de curent sau a unei cutii de joncțiuni (Fig. 5)
- în contact cu peretele sau cu podeaua
- în apropierea copertinelor, a altor materiale inflamabile, a combustibililor sau recipientelor sub presiune.



ATENȚIE:
Respectați distanțele indicate în figurile 3,4.



Instalați și utilizați aparatul doar potrivit indicațiilor din aceste instrucțiuni.



În situația în care cablul de alimentare este deteriorat, acesta trebuie să fie înlocuit de constructor sau de serviciul de asistență tehnică al acestuia ori de alte persoane calificate, pentru evitarea pericolelor. Nu utilizați aparatul dacă acesta sau controlerul electronic este defect.



Asigurați-vă că linia de alimentare este dotată cu un dispozitiv care permite separarea aparatului de la rețeaua proprie, inclusiv de la Firul Pilot, când este instalat, conform reglementărilor în vigoare.



ATENȚIE: pentru a evita supraîncălzirile periculoase, nu acoperiți în niciun caz aparatul (Fig.7). Nu împiedicați fluxul de aer introducând materiale în interior.



Pentru casarea aparatului, urmați reglementările în vigoare pentru eliminarea și gestionarea deșeurilor.

RO

1. CARACTERISTICI ALE APARATULUI

Tensiunea de alimentare: 230 V ~ 50 Hz

Clasa de izolație: II 

Grad de protecție: IPx4

TYPE	Putere [W]	Lungime [cm]	Înălțime [cm]	Greutate [kg]	Curent Nominal [A]
CVE0610F	1000	55	58	16	4,5
CVE0915F	1500	79	58	24	6,5
CVE1220F	2000	104	58	32	9
DVE0610F	1000	55	58	11	4,5
DVE0915F	1500	79	58	16	6,5
DVE1118F	1800	95	58	19	8
EVE0610F	1000	55	58	17	4,5
EVE0915F	1500	79	58	25	6,5
EVE1220F	2000	103	58	33	9

Tabel 1

 Datele tehnice ale aparatului sunt indicate pe eticheta cu funcții amplasată pe latura caloriferului (Fig. 1).

A	Marca/Producătorul	F	Izolare dublă
B	Model, tip, categorie	G	Modul de eliminare
C	Cod Bidimensional (QR)	H	Mărci de calitate
D	Grad de protecție	I	Tensiune de alimentare și Putere
E	Marcaj CE	L	Numărul de serie

2. INFORMAȚII GENERALE

 Dezambalați aparatul cu grijă, poziționându-l pe protecțiile din polistiren sau pe un covor.

Ambalajul conține:

- aparatul
- kit de fixare
- manual de instrucțiuni

 Citiți integral și cu atenție instrucțiunile mai înainte de instalare și utilizare. Păstrați-le pentru a le consulta ulterior.

 Instalați și utilizați aparatul doar potrivit indicațiilor din aceste instrucțiuni.

 Aceste instrucțiuni nu acoperă toate situațiile posibile care pot să intervină. Faceți întotdeauna uz de bun-simț și de prudență la instalare, funcționarea și păstrarea aparatului.

 Se interzice modificarea, în orice mod, a caracteristicilor aparatului și îndepărtarea oricărei părți fixe a acestuia, inclusiv a capacelor. Asigurați-vă că aparatul este întreg. Nu utilizați aparatul dacă este deteriorat, însă contactați vânzătorul sau o persoană autorizată.

 Materialele utilizate pentru ambalare pot fi reciclate. Se recomandă, prin urmare, depozitarea acestora în recipiente pentru colectare separată.

3. AMPLASAREA ȘI INSTALAREA

 Aparatul este construit pentru încălzirea spațiilor din locuințe sau similare. Nu trebuie să fie folosit pentru alte scopuri. Aparatul trebuie să fie utilizat pentru instalarea fixă pe perete conform indicațiilor din aceste instrucțiuni. Instalați aparatul cu termostatul poziționat în jos (Fig. 2).

 În camera de baie (dotată cu vană sau duș) instalați aparatul în afara zonei 1. Instalați aparatul astfel încât controlerul electronic și celelalte dispozitive de comandă să nu poată fi atinse de persoana care se află în cada de baie sau la duș. Se interzice utilizarea știftului de blocare pentru conectarea radiatorului.

 **Pentru radiatoarele gata prevăzute cu ștecher, urmați instrucțiunile de la pag 65.**

 Respectați distanțele indicate în figurile 3,4.

 Nu instalați aparatul:
- imediat dedesubtul sau în fața unei prize de curent sau a unei cutii de joncțiuni (Fig. 5)
- în contact cu peretele sau cu podeaua
- în apropierea copertinelor, a altor materiale inflamabile, a combustibililor sau recipientelor sub presiune.

 Asigurați-vă că nu există țevi sau cabluri electrice în interiorul peretelui care să poată fi deteriorate în timpul fixării.

 Aparatul este dotat cu un senzor capabil să detecteze deschiderea unei eventuale ferestre amplasate deasupra acestuia. Pentru o funcționare corectă a modului "Fereastră Deschisă", se recomandă să se verifice și să se respecte indicațiile de la Cap. 4.3.2 înainte de a fixa aparatul pe perete.

3.1 FIXAREA PE PERETE

 Asigurați-vă că șuruburile și diblurile incluse în pachetul de fixare sunt compatibile cu tipul de perete pe care se va instala aparatul. Pentru orice neclaritate, adresați-vă unor persoane calificate sau vânzătorului.

 Urmați ordinea de instalare indicată pe partea pliabilă a capacului (Schema 1), respectând distanța minimă dintre partea inferioară a caloriferului și pardoseală (Fig. 3).

 În timpul instalării, cablul de alimentare nu trebuie să fie conectat la linia electrică.

3.2 CONECTAREA ELECTRICĂ



ATENȚIE

Instalarea trebuie să fie efectuată de un tehnician specializat și în conformitate cu standardele în vigoare în țara respectivă.

La instalarea aparatului, asigurați-vă că acesta nu este alimentat electric și că întrerupătorul general al instalației este deschis pe poziția "0".



Alimentarea aparatului este de 230 V ~ 50 Hz. Asigurați-vă că linia electrică corespunde datelor din tabelul 1.



Asigurați-vă că linia de alimentare este dotată cu un dispozitiv care permite separarea aparatului de la rețeaua proprie, inclusiv de la Firul Pilot, când este instalat, conform reglementărilor în vigoare.

În cazul instalării în săli de baie, linia electrică trebuie să fie dotată cu un dispozitiv de protecție diferențială de înaltă sensibilitate, cu curent nominal diferențial de intervenție de 30 mA.

Linia de alimentare și unitatea de comandă a Firului Pilot trebuie să fie protejate cu același diferențial.

Efectuați conexiunea electrică în interiorul unei cutii de joncțiune.

În cazul unor spații umede (bucătărie, baie), conexiunea aparatului la circuit trebuie să fie localizată la minimum 25 cm de la podea.

Respectați cu strictețe schema de conexiuni electrice de la figura 8.



Dacă Firul Pilot nu este conectat la unitatea de programare, trebuie terminat și izolat. Nu conectați în niciun caz Firul Pilot la sol.



Cablul de alimentare nu trebuie să intre în niciun caz în contact cu suprafața aparatului (Fig.6).

4. REGLAREA ȘI FUNCȚIONAREA



Aparatul a fost construit pentru a încălzi mediul. Unele părți ale acestui produs pot deveni foarte calde și pot cauza arsuri. Trebuie să se acorde o atenție deosebită când sunt prezenți copii sau persoane vulnerabile.



Mențineți materialele combustibile, inflamabile și recipientele sub presiune (de exemplu tuburi de spray, extincătoare) la minimum 50 de cm de aparat. Nu pulverizați niciun fel de substanțe pe suprafață.



Nu atingeți aparatul cu mâinile sau cu picioarele umede sau ude. Nu umeziți controlerul electronic cu apă sau alte lichide. În cazul în care acest lucru are loc, întrerupeți alimentarea de curent și lăsați aparatul să se usuce complet.



Instalarea aparatului la altitudini mari determină o creștere a temperaturii aerului încălzit.



La prima pornire este normal ca aparatul să elibereze un miros care va dispărea în scurt timp. Se recomandă aerisirea camerei după prima utilizare.



În timpul pornirii aparatului în medii reci, este posibil ca acesta să emită zgomote metalice datorate dilatărilor de materiale.



În situația în care, în faza de fixare sau cu ocazia primelor porniri apar urme uleioase în partea inferioară a aparatului, ar putea fi prezent un rest de prelucrare. Curățați partea respectivă cu o atenție deosebită, la intervale de câte două zile. Dacă fenomenul continuă, urmați indicațiile din Cap. 7.

RO

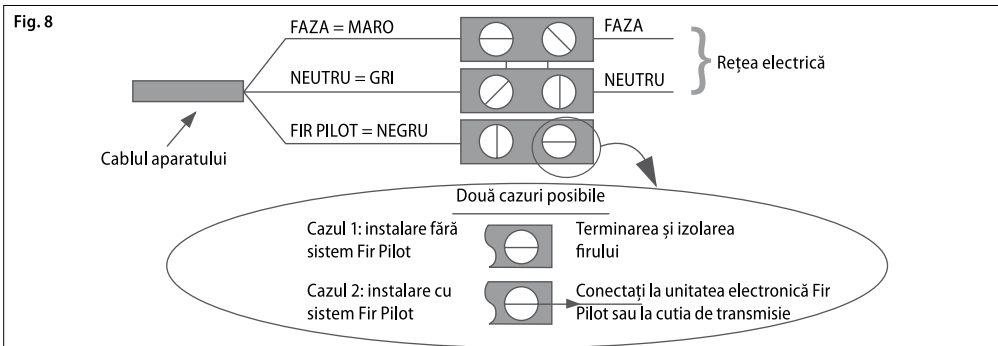

UTILIZAREA CALORIFERULUI DE LA PANOUL DE CONTROL:

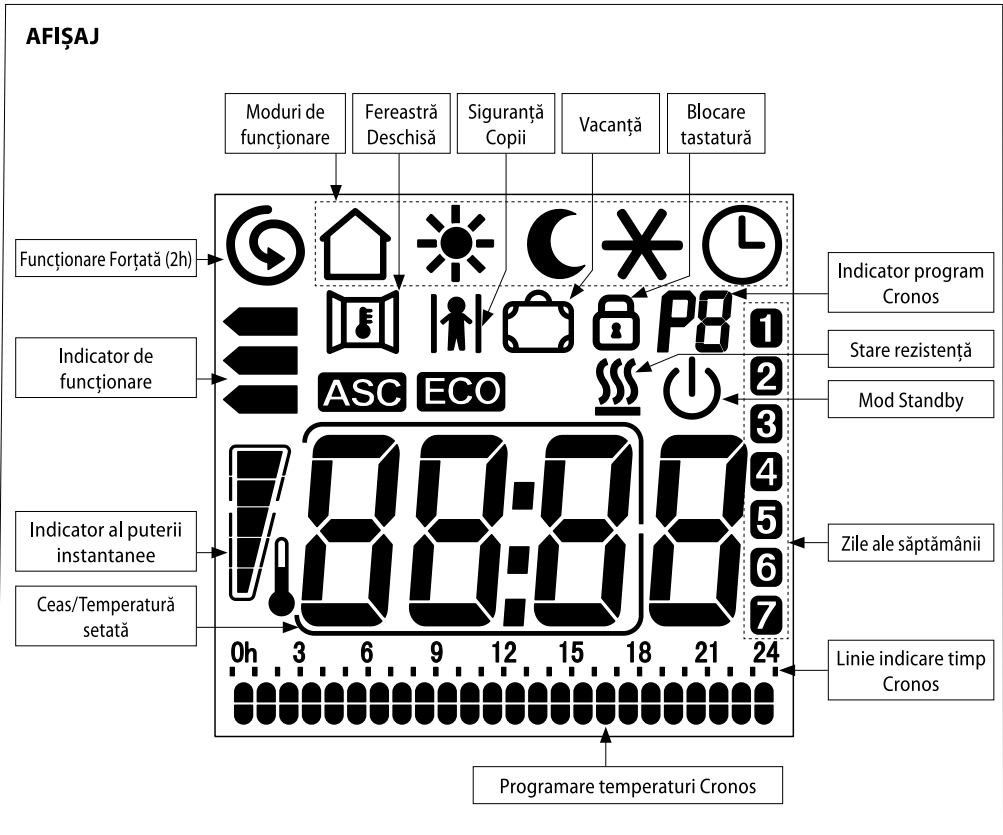
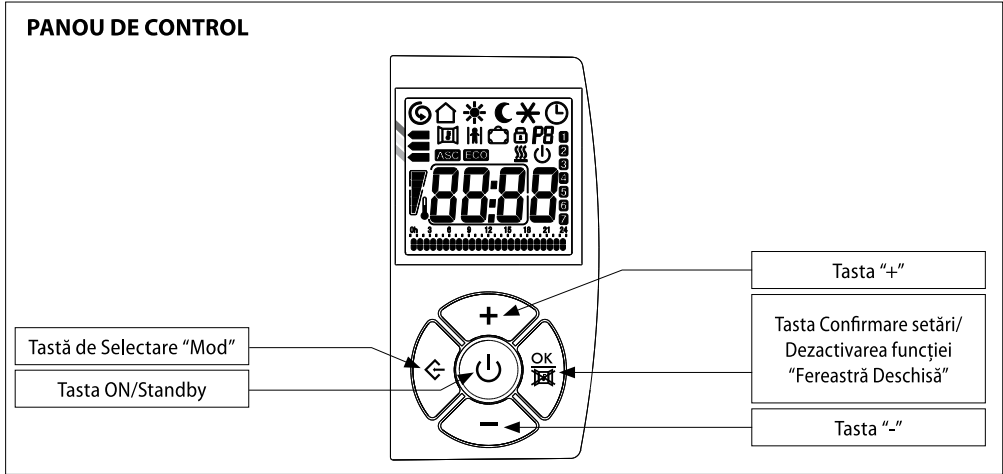

RO

4.1 MODE ON/STANDBY



În modul "Standby", afișajul vizualizează pictograma , ora și ziua săptămânii. Toate modurile, inclusiv "Fir Pilot", sunt suspendate, însă aparatul rămâne sub tensiune în așteptarea unei comenzi.



Pentru a porni sau a opri aparatul, apăsați tasta "Standby". Caloriferul pornește în modul de funcționare anterior opririi și emite un semnal acustic.

Afișajul vizualizează ora în modul "Cronos", iar în celelalte moduri afișează temperatura configurată.







Aparatul anunță, printr-un semnal acustic dublu, intrarea în modul "Standby" și, printr-un semnal acustic prelungit, ieșirea din acesta.

4.2 MODURI DE FUNCȚIONARE

Aparatul pune la dispoziție 6 moduri de funcționare care permit încălzirea mediului într-un mod corespunzător propriilor cerințe.



Apăsați tasta "Mod" pentru a alege modul de funcționare dorit. O pictogramă de pe afișaj indică modul de funcționare:

	Fir Pilot		Confort
	Noapte/Eco		Antigel
	Cronos		Energy Saving



FIR PILOT

Temperatura este programată prin comenzile "Fir Pilot".

Toate comenzile "Fir Pilot" sunt activate.



CONFORT

Temperatura "Confort" corespunde temperaturii dorite de client.

Toate comenzile "Fir Pilot" sunt dezactivate.



NOAPTE/ECO

Modul "Noapte/Eco" menține o temperatură confortabilă, cu un consum de energie redus.

Toate comenzile "Fir Pilot" sunt dezactivate.



ANTIGEL

În modul "Antigel", temperatura minimă este fixată la 7 °C.

Aparatul pornește automat în cazul unei temperaturi a camerei mai mică de 7 °C.

Toate comenzile "Fir Pilot" sunt dezactivate.



CRONOS

Acest mod permite selectarea unuia dintre cele trei programe de cronotermostat presetate sau a programului personalizabil. Acesta din urmă permite o programare zilnică și săptămânală, cu două niveluri de temperatură ("Confort" și "Noapte/Eco").

Toate comenzile "Fir Pilot" sunt dezactivate.



ENERGY SAVING

Acest mod permite reducerea consumurilor în situația în care se pleacă din cameră. Temperatura este fixată la 17 °C.

Toate comenzile "Fir Pilot" sunt dezactivate.

Când pe afișaj este vizualizată pictograma , rezistența este activă.

4.2.1 FIR PILOT

Pentru a activa modul "Fir Pilot":







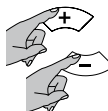

Apăsați tasta "Mod" până afișajul vizualizează pictograma .

Utilizatorul poate regla doar temperatura modului "Confort" de la aparat.



Selectați temperatura dorită folosind tastele "+" și "-".

Locuința trebuie să fie prevăzută cu un sistem de control care să accepte acest tip de tehnologie. În acest caz, pentru a verifica transmisia corectă a comenzilor de programare, este posibil să utilizați schema următoare, în funcție de modul setat:

Mod	Confort	Noapte/Eco (Confort -3,5 °C)	Antigel	Standby	Confort - 1 °C	Confort - 2 °C
Semnal de transmis						
Tensiune între Firul Pilot și neutru	0 volți	230 volți	115 volți negativ	115 volți pozitiv	230 volți pentru un interval de 3 s	230 volți pentru un interval de 7 s

Pictograma modului selectat de unitate electronică (Standby, Confort, Noapte/Eco, Antigel) apare pe display în completarea pictogramei .

Dacă Firul Pilot nu este conectat, se selectează automat modul "Confort".

RO

4.2.2 CONFORT ✱

Temperatura "Confort" corespunde temperaturii dorite de utilizator.



Apăsați tasta "Mod" până așajul vizualizează pictograma ✱



Selectați temperatura dorită folosind tastele "+" și "-".



Intervalul de reglare al temperaturii pornește de la 7 °C la 32 °C.

4.2.3 NOAPTE/ECO

În modul "Noapte/Eco", temperatura setată trebuie să fie egală sau mai mică decât temperatura "Confort". Dacă se dorește setarea unei temperaturi în modul "Confort" mai mică decât aceea din modul "Noapte/Eco", aceasta din urmă va fi modificată în consecință.



Apăsați tasta "Mod" până așajul vizualizează pictograma 

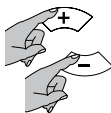

Selectați temperatura dorită folosind tastele "+" și "-".

Se recomandă folosirea acestui mod la orele nocturne, când camera este nelocuită cel puțin 2 ore.

4.2.4 ANTIGEL ✱

În modul "Antigel", temperatura este fixată la 7 °C. Aparatul pornește automat dacă sunt temperaturi ambiante mai mici de 7 °C și, printr-un consum minim de energie, nu permite ca spațiul să atingă temperaturi de îngheț.



Apăsați tasta "Mod" până așajul vizualizează pictograma ✱

Se recomandă folosirea acestui mod când camera este nelocuită cel puțin o zi.

4.2.5 CRONOS

Modul "Cronos" permite selectarea unuia dintre cele trei programe de cronotermostat presetate sau a programului personalizabil. Acesta din urmă permite setarea mai multor temperaturi ("Confort" și "Noapte/Eco") în decurs de 24 de ore, pentru fiecare zi a săptămânii.

ALEGEREA PROGRAMULUI



Apăsați tasta "Mod" până așajul vizualizează pictograma . Apoi apăsați simultan tastele "Mod" și "-", menținându-le apăsată minimum 3 secunde.

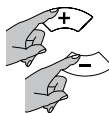

Numărul care indică programul (P1, P2, P3 și P4) clipește intermitent: apăsați butoanele "+" și "-" pentru a seta programul dorit. Apăsați butonul "Mod" pentru a confirma.

Acum clipește pictograma funcției ASC (a se vedea cap 4.3.1), apăsați tasta  pentru a activa funcția sau tasta "-" pentru a o dezactiva.

PROGRAM P1	ORE	MOD
DE LUNI PÂNĂ VINERI	0 - 6	Noapte/Eco
	6 - 9	Confort
	9 - 16	Noapte/Eco
	16 - 23	Confort
SĂMBĂTĂ ȘI DUMINICĂ	23 - 0	Noapte/Eco
	0 - 7	Noapte/Eco
	7 - 23	Confort
	23 - 0	Noapte/Eco

PROGRAM P2	ORE	MOD
DE LUNI PÂNĂ DUMINICĂ	0 - 7	Noapte/Eco
	7 - 23	Confort
	23 - 0	Noapte/Eco

PROGRAM P3	ORE	MOD
DE LUNI PÂNĂ VINERI	0 - 6	Noapte/Eco
	6 - 9	Confort
	9 - 13	Noapte/Eco
	13 - 23	Confort
SĂMBĂTĂ ȘI DUMINICĂ	23 - 0	Noapte/Eco
	0 - 7	Noapte/Eco
	7 - 23	Confort
	23 - 0	Noapte/Eco

PROGRAM P4 - PERSONALIZAT

Programul "P4" îi permite utilizatorului să seteze diverse temperaturi ("Confort" și "Noapte/Eco") în decurs de 24 de ore, pentru fiecare zi a săptămânii.

REGLAREA DATEI ȘI A OREI

Înainte de a efectua configurarea programului personalizabil P4, asigurați-vă că ora și ziua săptămânii sunt corecte.



În caz contrar, apăsați tasta "Mod" până când afișajul vizualizează pictograma ☹. Apoi apăsați din nou pe tasta "Mod" menținând-o apăsată până când numărul care indică ziua luminează intermitent.

1
2
3
4

Apăsați tastele "+" și "-" pentru a seta ziua corectă a săptămânii (1=LUN, 2=MAR,... 7=DUM). Apăsați butonul "Mod" pentru a confirma.

20:30

Repetati aceeași procedură pentru a regla orele.

20:30

Acum luminează intermitent minutele, utilizați tastele "+" și "-" pentru a le seta și apăsați tasta pentru a confirma și a ieși sau tasta "Mod" pentru a intra în modul de configurare al programului P4.

CONFIGURAREA PROGRAMULUI P4

Pentru a accesa modul de setare al programului personalizat P4, apăsați tasta "MOD" după ce ați efectuat reglarea minutelor (consultați REGLAREA OREI).

Începând cu prima zi, selectați intervalul orar dorit folosind butoanele "+" și "-" alegând, pentru fiecare oră, temperatura "Comfort" (linie dublă) sau temperatura "Noapte/Eco" (linie unică).

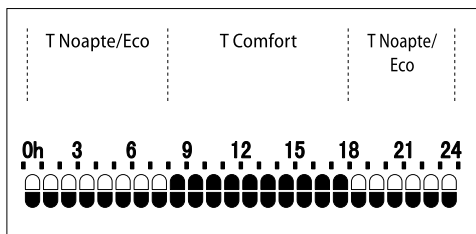

Apăsați tasta "Mod" pentru a confirma și repetați aceeași procedură pentru fiecare zi a săptămânii. Programarea săptămânală a fost setată cu succes.

Acum pictograma corespunzătoare funcției ASC luminează intermitent (a se vedea cap 4.3.1), apăsați tasta pentru a activa funcția sau tasta "-" pentru a o dezactiva.

4.2.6 ENERGY SAVING

În acest mod, temperatura este fixată la 17 °C. Modul "Energy Saving" permite reducerea consumului în cazul în care se pleacă din cameră, însă se dorește menținerea unei temperaturi confortabile.



Pentru a activa modul "Energy Saving", apăsați butonul "Mod" până ora/temperatura de pe afișaj sunt înlocuite cu mesajul "E S".

4.3 FUNCȚII

Aparatul este dotat cu funcții speciale care permit personalizarea și optimizarea utilizării aparatului.

4.3.1 ASC

Această funcție identifică inerția camerei pentru a atinge temperatura setată și anticipează pornirea caloriferului pentru ca temperatura "Comfort" să se producă la ora setată.

Pornirea aparatului poate fi anticipată de funcție cu maximum 2 ore.



Această funcție se poate activa și poate funcționa doar în modul "Cronos". (a se vedea Cap. 4.2.5)



Pentru funcționarea optimală a ASC este nevoie de câteva zile de preluare de date.

4.3.2 FEREASTRĂ DESCHISĂ

Funcția "Fereastră Deschisă" îi permite aparatului să detecteze automat dacă există ferestre deschise în apropierea caloriferului (de exemplu, în timpul curățeniei în casă) și să se seteze pe modul "Antigel" pentru a împiedica încălzirea inutilă și eventualele pierderi de energie. În același mod, poate identifica închiderea ferestrei și restabilirea condiției de funcționare configurată anterior.

La pornirea aparatului, funcția este deja activă, în așteptarea detectării unei eventuale deschideri a ferestrei.



Pentru a activa sau a dezactiva funcția, apăsați tasta și mențineți-o apăsată până când pictograma apare sau dispare de pe afișaj.

Când se detectează deschiderea unei ferestre, pictograma "Fereastră Deschisă" luminează intermitent.



În acest moment, la apăsarea tastei se poate anula acțiunea funcției "Fereastră Deschisă" până la detectarea unei deschideri ulterioare. Pictograma încetează să lumineze intermitent.

Pentru a garanta funcționarea optimală a caracteristicii, se recomandă instalarea aparatului în dreptul unei ferestre (Fig. 9).

RO

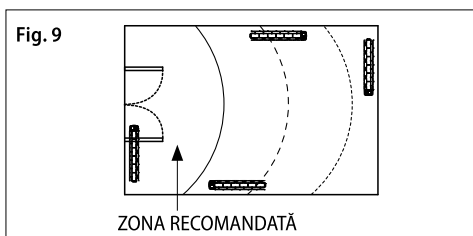

Răspunsul aparatului la deschiderile și închiderile ferestrei depinde de mai mulți factori, printre care temperatura setată pe aparat, temperatura externă, gradul de ventilație al încăperii în care este instalat caloriferul, poziția caloriferului în cameră, prezența unor altor surse de căldură.



Funcția "Fereastră Deschisă" nu se poate activa sau dezactiva din modul "Standby".



Dacă aparatul a detectat deschiderea unei ferestre, se pot selecta toate modulele și funcția "Funcționare Forțată (2h)", însă nu pot deveni active până la detectarea închiderii ferestrei sau a anulării funcției "Fereastră Deschisă". Funcțiile "Siguranță Copii" și "Blocare Tastatură" rămân în continuare active și se pot activa sau dezactiva și când aparatul a identificat deschiderea unei ferestre.

4.3.3 SIGURANȚĂ COPII

Prin activarea funcției "Siguranță Copii", temperatura superficială a aparatului se reduce față de funcționarea normală a modului activ ("Confort", "Noapte/Eco" etc.) pentru a diminua riscul de arsuri în caz de contact scurt și accidental.

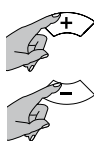

Pentru a activa funcția, apăsați simultan tastele "+" și "-" menținându-le apăstate până apare simbolul  pe afișaj.

Pentru a dezactiva funcția, repetați aceeași operațiune.

Funcția "Siguranță Copii" se poate activa din orice mod de funcționare, inclusiv în modul "Funcționare Forțată (2h)". Funcția nu se poate activa dacă aparatul se află în "Standby".

OBSERVAȚII IMPORTANTE:

În această funcție, energia termică eliberată de aparat se reduce și, prin urmare, este nevoie de un timp mai îndelungat pentru încălzirea camerelor.

Când se utilizează această funcție, copiii trebuie să fie supravegheați pentru a fi siguri că nu se află în condiții periculoase.



Totuși, trebuie să se evite orice contact prelungit între părțile corpului și aparat.

Dacă aparatul este deja în funcțiune sau este cald din cauza unei utilizări recente și se pornește funcția "Siguranță Copii", este nevoie de minimum două ore pentru ca temperatura să scadă la valoarea mai mică și funcția să poată fi utilizată.

4.3.4 FUNCȚIONARE FORȚATĂ (2H)

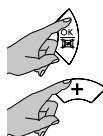
Activați funcția "Funcționare Forțată (2h)" pentru a încălzi camera mai rapid.



Pentru a activa funcția, apăsați simultan tastele  și "+" menținându-le apăstate până apare simbolul  pe afișaj.

Minutele care lipsesc până la finalul celor două ore sunt vizualizate pe display în locul orei.

Aparatul încălzește timp de două ore la putere maximă ignorând setarea anterioară de temperatură.

Pentru a dezactiva funcția "Funcționare Forțată (2h)", apăsați simultan cele două taste, așa cum ați procedat mai sus.

După două ore de la activare, funcția "Funcționare Forțată (2h)" se dezactivează automat, iar aparatul revine în modul de operare selectat anterior.





Funcția "Siguranță copii" limitează puterea caloriferului și în funcția "Funcționare Forțată (2h)".



Dacă aparatul a detectat deschiderea unei ferestre, funcția "Funcționare Forțată (2h)" nu se activează până când se detectează închiderea ferestrei sau anularea funcției "Fereastră Deschisă" (a se vedea Cap. 4.3.2), între timp, numărătoarea inversă la sfârșitul celor două ore continuă.

4.3.5 VACANȚĂ

În situația în care plecați de acasă pe un număr prestabilit de zile, caloriferul se poate seta astfel încât să se mențină pe modul "Antigel" pe întreaga perioadă a absenței și să se reactiveze automat în modul selectat anterior după terminarea zilelor setate.

Pentru a activa funcția, apăsați simultan tastele  și “-” menținându-le apăsată până apare simbolul  pe afișaj.

Folosiți tastele “+” și “-” pentru a seta numărul de zile (maximum 45 de zile).
Setarea dorită se confirmă automat.

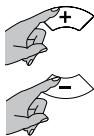

În acest punct, afișajul vizualizează pictograma  și numărul de zile configurat, care crește progresiv odată cu trecerea zilelor.

Pentru a dezactiva funcția, apăsați simultan tastele  și “-”.

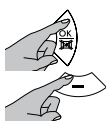

4.3.6 BLOCARE TASTATURĂ

Tastatura comenzii se poate bloca pentru a se evita modificările accidentale.

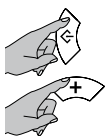

Pentru a activa funcția, apăsați simultan tastele “Mod” și “+” menținându-le apăsată până apare simbolul  pe afișaj.

Pentru a debloca tastatura, apăsați simultan cele două taste, așa cum ați procedat mai sus.

Pictograma “Blocare tastatură” nu va mai fi vizualizată pe afișaj.

IMPORTANT: Funcția “Blocare tastatură” nu inhibă tasta “Standby” care, astfel, este întotdeauna în stare de funcționare, chiar și atunci când funcția “Blocare tastatură” este activă.

4.4 INDICATOR DE FUNCȚIONARE

Indicatorul de funcționare vă permite să verificați dacă temperatura pe care ați setat-o este adecvată temperaturilor recomandate pentru a evita pierderile și a reduce consumul de energie.

O săgeată se va poziționa în dreptul uneia dintre cele trei linii colorate, care reprezintă calitativ consumul energetic conform schemei următoare:

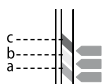

(a) **Verde:** Temperatura aleasă este deja mai mică decât aceea recomandată.

(b) **Galben:** Temperatura este potrivită, însă se recomandă să o reduceți ușor.

(c) **Roșu:** Temperatura aleasă este ridicată, ar fi bine să o reduceți.

ATENȚIE: Indicatorul oferă doar o indicație calitativă a consumului energetic, nu o valoare absolută.

4.5 INDICATOR AL PUTERII INSTANTANEE

Acest grafic oferă o reprezentare imediată a utilizării puterii caloriferului (fiecare sector reprezintă 20% din putere).

IMPORTANT: În cazul întreruperii alimentării electrice, se mențin toate setările curente, însă se pierde setarea datei și a orei.

Dacă alimentarea se întrerupe când este activat modul “Cronos”, caloriferul se va reactiva în modul “Energy Saving”.

IMPORTANT: Dacă alimentarea se întrerupe când este activat modul “Funcționare Forțată (2h)”, la restabilirea acesteia se va pierde setarea datei și a orei, iar aparatul va ieși din modul de funcționare setându-se automat pe modul selectat anterior.

IMPORTANT: În cazul întreruperii alimentării când este activată funcția “Vacanță”, la restabilirea alimentării funcția rămâne activă și reia în mod invers numărătoarea zilelor lipsă de la momentul întreruperii.

IMPORTANT: În cazul întreruperii alimentării când este activată funcția “ASC”, la restabilirea alimentării funcția este activă și necesită câteva zile pentru a redeveni complet operativă.

5. CURĂȚARE



Înainte de fiecare operațiune de curățare, asigurați-vă că aparatul este închis, rece și deconectat de la rețeaua electrică.



Pentru curățare, este suficient să utilizați o cârpă umedă și moale, cu un detergent neutru. Nu utilizați detergenți abrazivi, corozivi sau solvenți.



Pentru a menține aparatul în stare de eficiență, îndepărtați praful de pe suprafață și din interiorul acestuia cel puțin de două ori pe an cu ajutorul unui aspirator.

6. ÎNTREȚINERE



În cazul unor probleme tehnice, adresați-vă unor persoane calificate (recunoscute și autorizate de vânzător sau de producător) sau contactați vânzătorul.



Orice intervenție pe aparat trebuie să fie efectuată de personal calificat care, înainte de orice operațiune de întreținere, trebuie să se asigure că aparatul este închis, rece și deconectat de la curent.

7. PROBLEME ȘI SOLUȚII

Aparatul nu încălzește.	<ul style="list-style-type: none"> Asigurați-vă că există alimentare cu energie electrică și că aparatul este conectat corect. Verificați poziția întrerupătorului general. Măriți temperatura setată pe regulatorul de temperatură al aparatului. În funcție de tipul de rezistență instalat, aparatul devine cald după câteva zeci de minute. Așteptați cât este necesar. A intervenit dispozitivul de siguranță. Eliminați cauza supraîncălzirii (de exemplu, obstacole, acoperiri). Deconectați aparatul de la rețeaua electrică timp de câteva minute pentru a reseta sistemul electronic. Dacă nici acum nu încălzește, contactați vânzătorul sau o persoană autorizată.
Aparatul încălzește în continuare.	<ul style="list-style-type: none"> Scădeți temperatura setată pe regulatorul de temperatură al aparatului. Asigurați-vă că nu ați activat accidental funcția "Funcționare Forțată (2h)". Dacă continuă să încălzească, contactați vânzătorul sau o persoană autorizată.
Camera rămâne rece.	<ul style="list-style-type: none"> Verificați dacă puterea aparatului este corespunzătoare cerințelor camerei de încălzit. În cazul primei porniri, camera are nevoie de câteva ore pentru a atinge temperatura dorită (aducerea la maximum a reglării nu determină creșterea temperaturii mai rapid).
Aparatul nu se răcește.	<ul style="list-style-type: none"> În funcție de tipul de rezistență instalat, aparatul devine rece după câteva zeci de minute. Așteptați cât este necesar.
Pierderi de lichid din aparat.	<ul style="list-style-type: none"> Oprii aparatul și contactați vânzătorul. Uscați pierderile utilizând mănuși de protecție contra produselor chimice. Nu le permiteți copiilor sau animalelor domestice să se apropie de lichid.
Aparatul nu răspunde corect la comenzile care vin de la unitatea Fir Pilot.	<ul style="list-style-type: none"> Deconectați aparatul de la curent (poziționați întrerupătorul general al instalației pe poziția "O"). Asigurați-vă că legătura se efectuează conform indicațiilor din aceste instrucțiuni (Fig.8) și că unitatea de comandă funcționează corect. Contactați o persoană calificată.
Aparatul continuă să încălzească, chiar dacă fereastra este deschisă în timp ce funcția "Fereastră Deschisă" este activă.	<ul style="list-style-type: none"> Poate fi nevoie să așteptați câteva minute înainte ca funcția să devină operativă. Este posibil ca diferența dintre temperatura exterioară și aceea interioară să nu fie suficientă pentru ca funcția să se activeze. Asigurați-vă că aparatul este poziționat conform indicațiilor din capitolul 4.3.2 din acest manual. Asigurați-vă că în spațiul din jurul părții de comandă a caloriferului nu sunt prezente obiecte. Dacă problema continuă, contactați vânzătorul sau o persoană autorizată.
Aparatul nu reîncepe să încălzească după închiderea ferestrei în timp ce funcția "Fereastră Deschisă" este activă.	<ul style="list-style-type: none"> Se poate să fie nevoie să așteptați câteva minute înainte ca senzorul să detecteze închiderea ferestrei. Asigurați-vă că în spațiul din jurul părții de comandă a caloriferului nu sunt prezente obiecte. Dezactivați și reactivați funcția. Dacă timpul de răspuns al funcției este prea mare, puteți reporni caloriferul manual. Dacă problema continuă, contactați vânzătorul sau o persoană autorizată.
Pe display se afișează mesajul "ALL".	<ul style="list-style-type: none"> Sonda de temperatură este defectă. Oprii aparatul și contactați vânzătorul.

8. GARANȚIE



Se recomandă păstrarea ambalajului integral pentru eventuala returnare a aparatului către vânzător, aparatul trebuie să fie returnat întreg în vederea îndeplinirii condițiilor de garanție.

Producătorul garantează propriilor clienți toate drepturile menționate în directiva europeană 1999/44/CE, precum și drepturile consumatorilor recunoscute de legislațiile naționale. Garanția acoperă în mod specific orice neconformitate și viciu de producție prezent pe produs în momentul vânzării și care apare în decurs de doi ani de la data cumpărării și îi oferă clientului dreptul de a obține repararea gratuită a produsului defect sau înlocuirea acestuia în cazul în care nu mai poate fi reparat.

Drepturile sus-menționate se anulează în următoarele situații:

- defecte cauzate de utilizări diferite de cele specificate în acest manual, care face parte integrantă din contractul de vânzare;
- defecte cauzate de spargerea accidentală, neglijență sau manipulări neautorizate.

Nu se consideră prestații în garanție intervențiile privind instalarea, racordarea la instalațiile de alimentare și operațiunile de întreținere menționate în manualul de instrucțiuni.

Producătorul nu acceptă nicio responsabilitate pentru daunele sau rănile cauzate direct sau indirect persoanelor, obiectelor sau animalelor domestice ca rezultat al neaplicării indicațiilor din acest manual, cu referire specială la avertismentele privind instalarea, punerea în funcțiune și utilizarea produsului.

Pentru a beneficia de drepturile de mai sus, Clientul trebuie să contacteze vânzătorul și să facă dovada unui document de achiziționare eliberat de vânzător, pe care să fie inclusă data achiziționării produsului.

9. ELIMINAREA



Cablul de alimentare trebuie să fie deconectat de la linia electrică înainte de efectuarea oricărei operațiuni. Pentru demontare, efectuați invers fazele de fixare pe perete (Schema 1).

Pentru casarea aparatului, urmați reglementările în vigoare pentru eliminarea și gestionarea deșeurilor.



Avertismente pentru eliminarea corectă a produsului conform directivei europene 2012/19/EC.

La sfârșitul duratei sale de viață utilă, produsul nu trebuie să fie eliminat împreună cu deșeurile municipale.

Acesta poate fi predat la centrele speciale de colectare separată stabilite de administrațiile municipale sau la vânzătorii care furnizează acest serviciu.



Acest aparat este conform cu directivele europene:
2014/30/EU privind compatibilitatea electromagnetică
2014/35/EU privind joasa tensiune
2011/65/EU privind restricționarea utilizării substanțelor periculoase



CONEXIUNEA ELECTRICĂ CU ȘTECHER A SE CITI CU ATENȚIE

Înainte de a introduce ștecherul în priza de curent, verificați cu atenție dacă tensiunea rețelei de acasă corespunde cu valoarea V indicată pe plăcuța cu caracteristici a aparatului și dacă priza de curent și linia de alimentare sunt dimensionate corect față de puterea dispozitivului (și aceasta fiind indicată pe plăcuța cu caracteristici).

Asigurați-vă că linia de alimentare este dotată cu un dispozitiv care permite separarea aparatului de la rețeaua proprie conform reglementărilor în vigoare.

Linia electrică trebuie să fie dotată cu un dispozitiv de protecție diferențială de înaltă sensibilitate, cu curent nominal diferențial de intervenție care să nu depășească 30 mA.

Toate referințele din manual privind utilizarea modului "Fir Pilot" (Fil Pilote) și conexiunile aferente trebuie ignorate deoarece aparatul nu este prevăzut cu acest mod de funcționare.

Cerințe privind informațiile referitoare la aparatele electrice pentru încălzire locală

Identificatorul de model(e): (vezi eticheta cu caracteristicile produsului)

Date de contact:

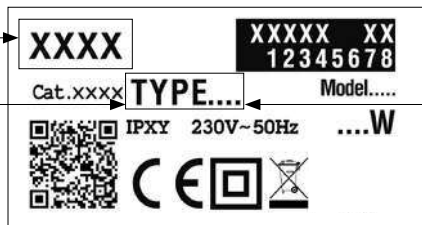

PUTEREA TERMICĂ	TIP	VALOARE	UNITATE
Puterea termică nominală (P_{nom})	xVExx07x	0,7	kW
	xVExx09x	0,9	
	xVExx10x	1,0	
	xVExx12x	1,2	
	xVExx15x	1,5	
	xVExx18x	1,8	
	xVExx20x	2,0	
Puterea termică minimă (cu titlu indicativ) (P_{min})	xVExx07x	0,0	kW
	xVExx09x		
	xVExx10x		
	xVExx12x		
	xVExx15x		
	xVExx18x		
	xVExx20x		
Puterea termică maximă continuă ($P_{max,c}$)	xVExx07x	0,7	kW
	xVExx09x	0,9	
	xVExx10x	1,0	
	xVExx12x	1,2	
	xVExx15x	1,5	
	xVExx18x	1,8	
	xVExx20x	2,0	

CONSUM AUXILIAR DE ELECTRICITATE	TIP	VALOARE	UNITATE
La putere termică nominală ($e_{l,max}$)	xVExx07x	0,000	kW
	xVExx09x		
	xVExx10x		
	xVExx12x		
	xVExx15x		
	xVExx18x		
	xVExx20x		
La putere termică minimă ($e_{l,min}$)	xVExx07x	0,000	kW
	xVExx09x		
	xVExx10x		
	xVExx12x		
	xVExx15x		
	xVExx18x		
	xVExx20x		
În modul standby ($e_{l,sg}$)	xVExx07x	0,000	kW
	xVExx09x		
	xVExx10x		
	xVExx12x		
	xVExx15x		
	xVExx18x		
	xVExx20x		

RO

Tip de putere termică/controlul temperaturii camerei

- cu o singură treaptă de putere termică, fără controlul temperaturii camerei [NU]
- două sau mai multe trepte de putere manuale, fără controlul temperaturii camerei [NU]
- cu controlul temperaturii camerei prin intermediul unui termostat mecanic [NU]
- cu control electronic al temperaturii camerei [NU]
- cu control electronic al temperaturii camerei și cu temporizator cu programare zilnică [NU]
- cu control electronic al temperaturii camerei și cu temporizator cu programare săptămânală [DA]

Alte opțiuni de control

- controlul temperaturii camerei, cu detectarea prezenței [NU]
- controlul temperaturii camerei, cu detectarea unei ferestre deschise [DA]
- cu opțiune de control la distanță [NU]
- cu demaraj adaptabil [DA]
- cu limitarea timpului de funcționare [NU]
- cu senzor cu bulb negru [NU]

Addresses

Manufacturer • Fabricant • Producent

Producător:

UK Manufacturer:

Kingfisher International Products Limited,
3 Sheldon Square, London, W2 6PX,
United Kingdom

EU Manufacturer:

Kingfisher International Products B.V.
Rapenburgerstraat 175E
1011 VM Amsterdam
The Netherlands
www.kingfisher.com/products

EN www.diy.com | www.screwfix.com | www.screwfix.ie

To view instruction manuals online,
visit www.kingfisher.com/products

FR www.castorama.fr
www.bricodepot.fr

Pour consulter les manuels d'instructions
en ligne, rendez-vous sur le site
www.kingfisher.com/products

PL www.castorama.pl

Aby zapoznać się z instrukcją obsługi online,
odwiedź stronę www.kingfisher.com/products

RO www.bricodepot.ro

Pentru a consulta manualele de instrucțiuni online,
vizitați www.kingfisher.com/products

FR Garantie

Ce produit bénéficie d'une garantie de 2 ans à partir de la date d'achat.

La garantie couvre les pannes et dysfonctionnements de l'appareil dans le cadre d'une utilisation conforme à la destination du produit et aux informations du manuel d'utilisation.

Pour être pris en charge au titre de la garantie, la preuve d'achat est obligatoire (ticket de caisse ou facture) et le produit doit être complet avec l'ensemble de ses accessoires.

La clause de garantie ne couvre pas des détériorations provenant d'une usure normale, d'un manque d'entretien, d'une négligen-

ce, d'un montage défectueux, ou d'une utilisation inappropriée (chocs, non respect des préconisations d'alimentation électrique, stockage, conditions d'utilisation...).

Sont également exclues de la garantie les conséquences néfastes dues à l'emploi d'accessoires ou de pièces de rechange non d'origine, ou non adaptées, au démontage ou à la modification de l'appareil.

Brico Dépôt et Castorama restent tenues des défauts de conformité du bien au contrat et des vices rédhibitoires dans les conditions prévues aux articles 1641 à 1649 du Code Civil.

xVExxxF/V



Cod.
5725011342/11.20