



EN Care  
 RUS Уход  
 PT Aviso

FR Entretien  
 RO Îngrijire  
 TR Bakım

PL Pielęgnacja  
 ES Advertancia

01

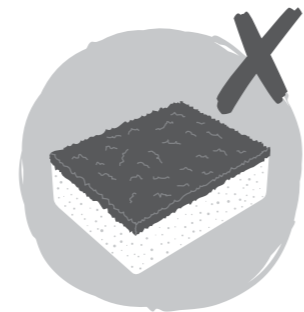
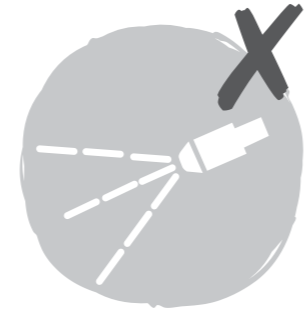
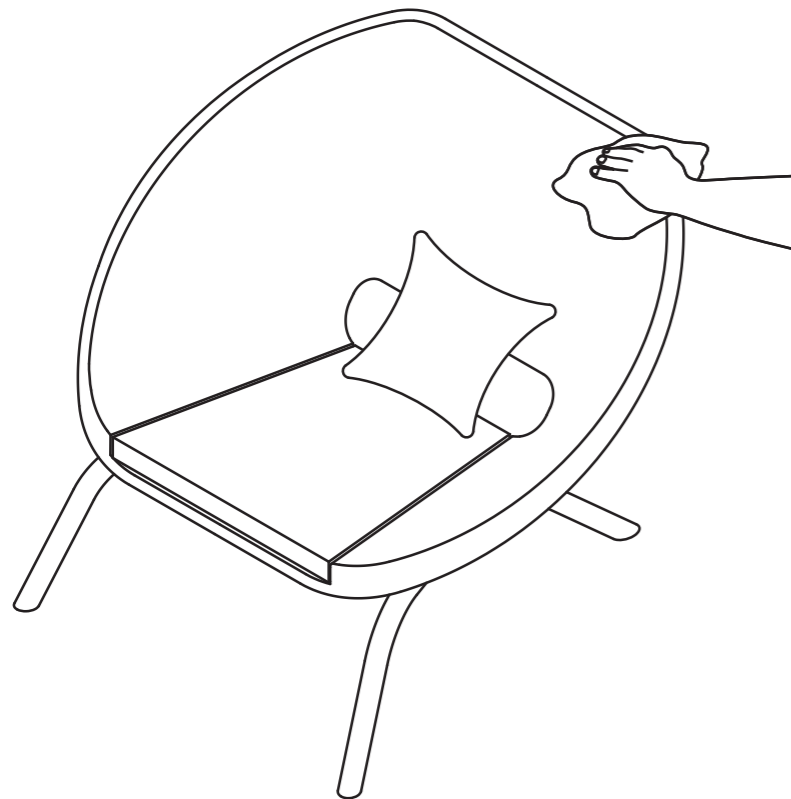
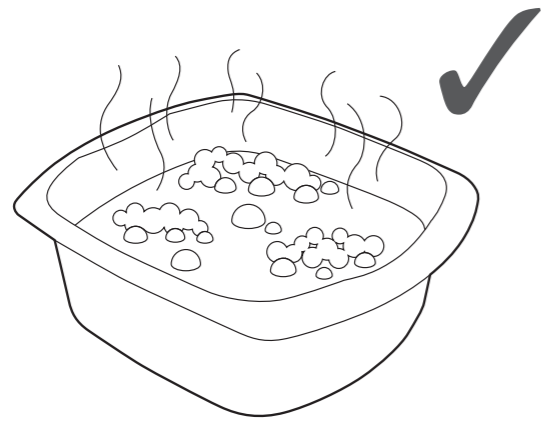
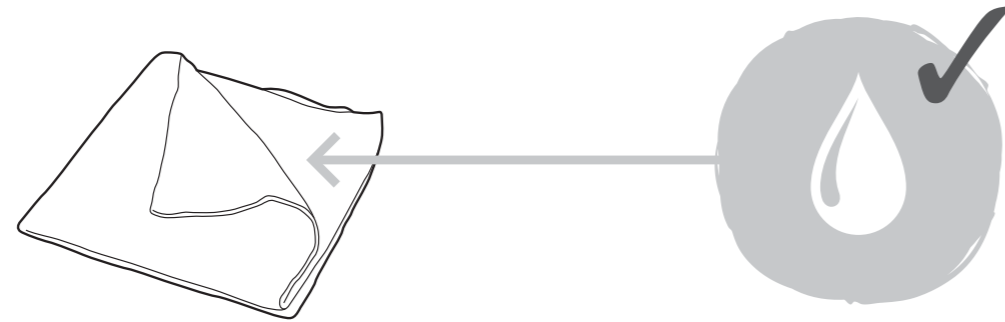

blooma 

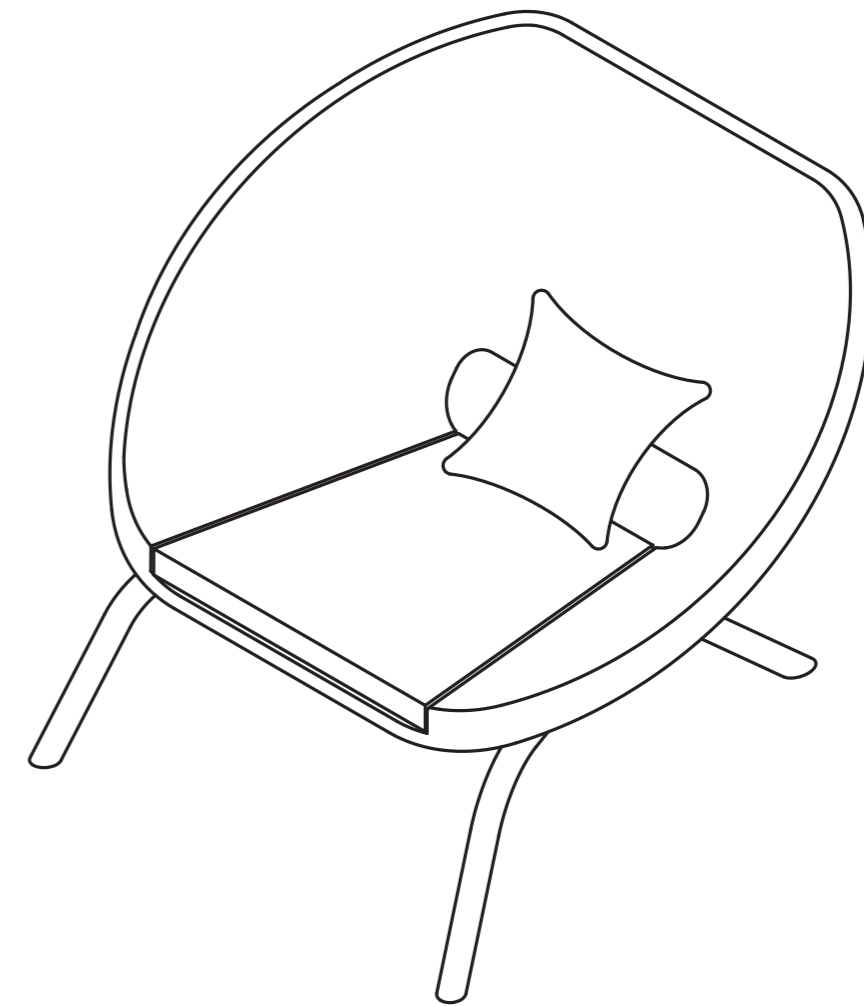

3663602936756 / 3663602937371

**Loa**

V10916



EN IMPORTANT - Please read carefully the separate safety guide before use.

FR IMPORTANT - Lire attentivement le guide de sécurité séparé avant utilisation.

PL WAŻNE - Przed użyciem proszę dokładnie zapoznać się z instrukcją bezpieczeństwa.

RUS ВАЖНО - Пожалуйста, внимательно прочитайте отдельное руководство по технике безопасности перед использованием.

RO IMPORTANT - Vă rugăm să citiți cu atenție ghidul de siguranță separat înainte de utilizare.

ES IMPORTANTE - Lea atentamente la guía de seguridad separado antes de utilizar.

PT IMPORTANTE - Leia atentamente o guia de segurança separado antes de usar.

TR ÖNEMLI - Kullanmadan önce emniyet kurallarını lütfen dikkatle okuyun.



01

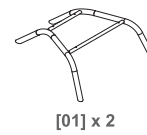

[01] x 2



[02] x 2



[05] x 8



[06] x 8



[07] x 8

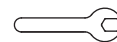

[08] x 2

EN Assembly  
RUS Сборка  
PT Montagem

FR Assemblage  
RO Asamblare  
TR Montaj

PL Montaż  
ES Montaje

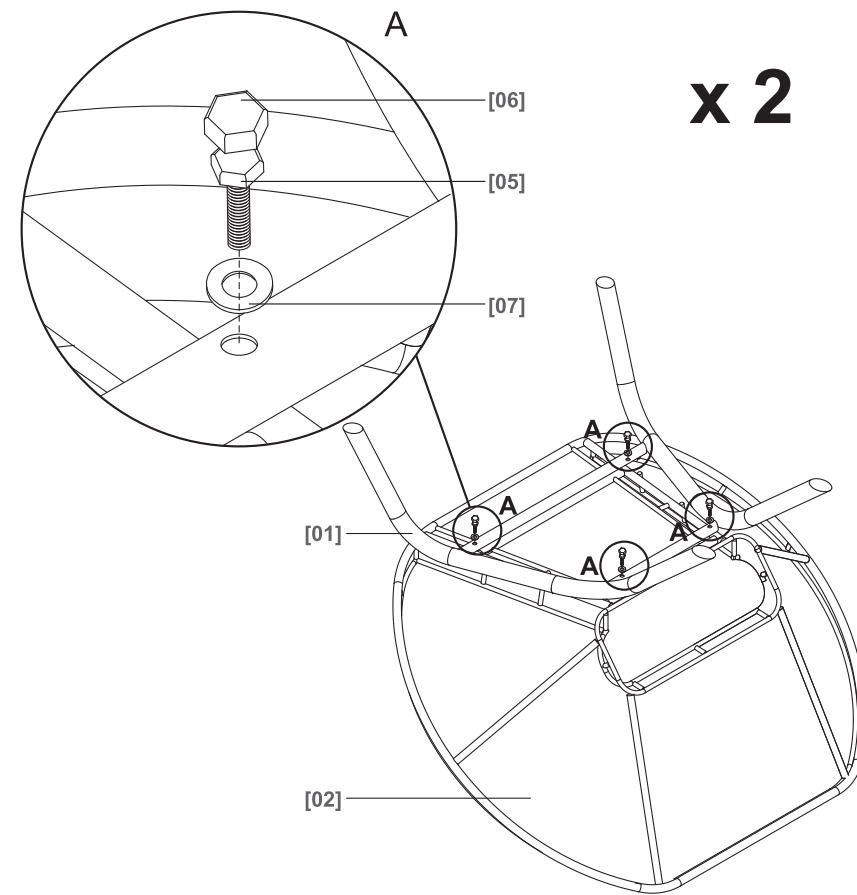

x 2

02

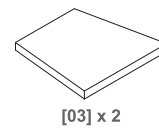

[03] x 2



[04] x 2

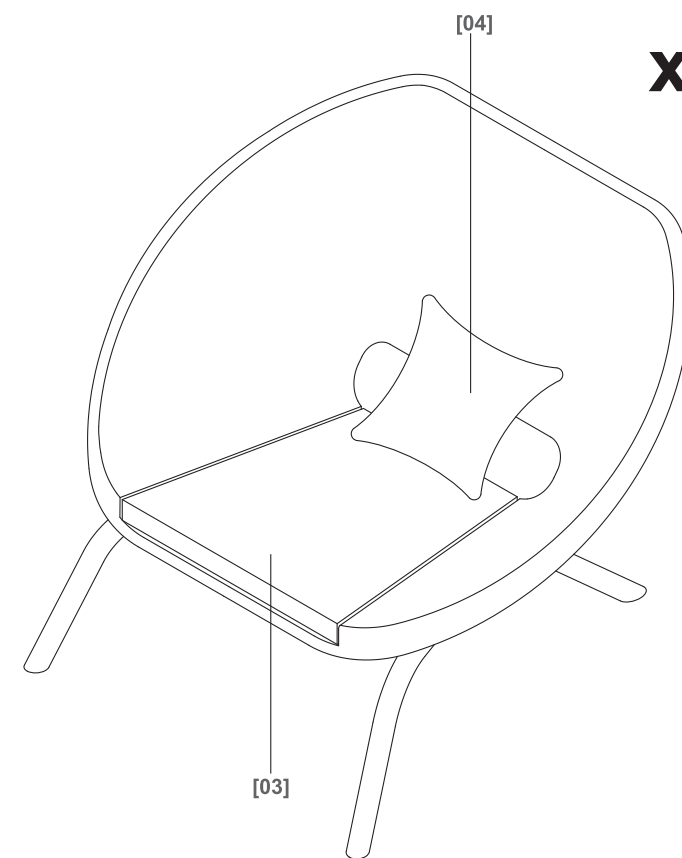

x 2

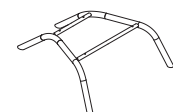

[01] x 2



[02] x 2

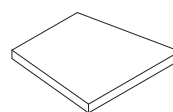

[03] x 2



[04] x 2



[05] x 8  
(M6 x 45mm)



[06] x 8  
(M6)



[07] x 8  
(M6)

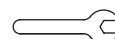

[08] x 2  
(M6)



blooma 



**3663602936749, 3663602937364, 3663602936756, 3663602937371**

# Loa

V11016

**EN****Safety**

- For domestic use only.
- Always use on firm level ground.
- Periodic structural checks of this product should be undertaken, do not use if you have any doubts about its fitness for purpose.
- Do not stand on the seat.
- Do not sit on the armrest.
- Do not let children play with this product.
- This product must be set up by a competent adult.
- Maximum load per seat: 110 kg.

**At the beginning of the season**

- Check to ensure that all components and fixings of this product are secure, do not use if you have any doubts about its fitness for purpose.

**At the end of the season**

- This product should be stored under cover during prolonged spells of adverse weather (wet or cold) and also during the winter (ideally in a garden shed or garage).
- Always clean and dry thoroughly before storage.

**Manufacturer:**

Kingfisher International Products Limited,  
3 Sheldon Square, London, W2 6PX,  
United Kingdom

**Distributor:**

B&Q plc, Chandlers Ford, Hants, SO53 3LE  
United Kingdom [www.diy.com](http://www.diy.com)  
SFD Limited, Trade House, Mead Avenue,  
Yeovil, BA22 8RT, United Kingdom

## IMPORTANT, RETAIN FOR FUTURE REFERENCE: READ CAREFULLY.

**FR****Sécurité**

- Produit à usage domestique.
- Positionnez le produit de manière stable sur une surface plane.
- Vérifiez régulièrement ce produit. En cas de doute, ne l'utilisez pas.
- Ne vous mettez pas debout sur le siège.
- Ne vous asseyez pas sur l'accoudoir.
- Ne laissez pas les enfants manipuler ce produit.
- Ce produit doit être monté par un adulte compétent.
- Charge maximale par siège : 110 kg.
- A monter soi-même.

**En début de saison**

- Vérifiez que tous les composants et fixations de ce produit soient fermement serrés. En cas de doute, ne l'utilisez pas.

**En fin de saison**

- L'hiver ou en cas d'intempéries prolongées, il est recommandé de ranger ce produit dans un garage ou une pièce aérée sans chauffage. Ne le couvrez pas.
- Nettoyez et séchez toujours le produit avant de le ranger.

**Fabricant:**

Kingfisher International Products Limited,  
3 Sheldon Square, London, W2 6PX,  
United Kingdom

**Distributeur:**

Castorama France C.S. 50101 Templemars  
59637 Wattignies CEDEX [www.castorama.fr](http://www.castorama.fr)  
BRICO DÉPÔT 30-32 rue de la Tourelle  
91310 Longpont-sur-Orge France  
[www.bricodepot.com](http://www.bricodepot.com)

## IMPORTANT – A CONSERVER POUR DE FUTURS BESOINS DE REFERENCE : A LIRE SOIGNEUSEMENT

**PL****Bezpieczeństwo**

- Meble przeznaczone do użytku prywatnego.
- Zawsze umieszczaj produkt na stabilnej, równej powierzchni.
- Należy okresowo sprawdzać stan produktu. Nie używaj go, jeśli masz jakiegokolwiek wątpliwości.
- Nie stawaj na siedzisku.
- Nie siadaj na podłokietnikach.
- Nie pozwól, aby produktem bawiły się dzieci.
- Niniejszy mebel musi zostać zmontowany przez kompetentną osobę dorosłą.
- Maksymalne obciążenie na siedzisko: 110 kg.

**Na początku sezonu**

- Przed użyciem proszę upewnić się, że wszystkie części i elementy montażowe zostały prawidłowo przymocowane. Nie używaj produktu, jeśli masz jakiegokolwiek wątpliwości na temat ich przydatności do użycia.

**Na końcu sezonu**

- Niniejszy produkt powinien być przykryty pokrowcem podczas jego przechowywania, jeśli nie zamierzone jest jego użycie przez dłuższy okres czasu lub podczas złych warunków atmosferycznych (opady deszczu lub niska temperatura otoczenia) oraz podczas zimy (najlepiej przechowywać w schowku lub w garażu).
- Zawsze wyczyść i osusz produkty przed przechowywaniem.

**Producent:**

Kingfisher International Products Limited,  
3 Sheldon Square, London, W2 6PX,  
United Kingdom

**Dystrybutor:**

Castorama Polska Sp. z o.o.  
ul. Krakowiaków 78  
02-255 Warszawa  
[www.castorama.pl](http://www.castorama.pl)

## WAŻNE – NALEŻY DOKŁADNIE PRZECZYTAĆ NINIEJSZE INFORMACJE I ZACHOWAĆ.