

CARPORT

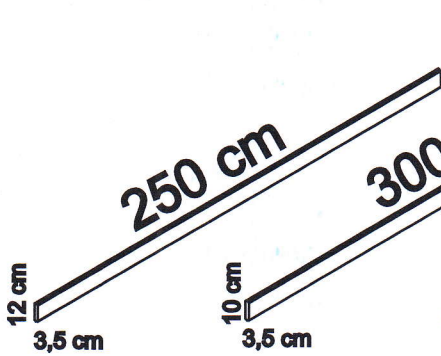

① x6 pcs



② x4 pcs

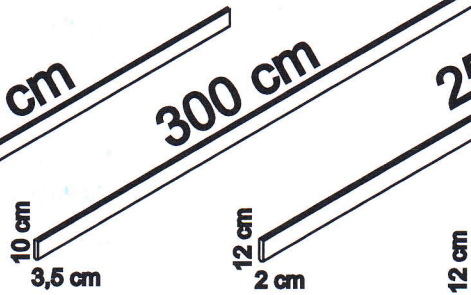

③ x7 pcs

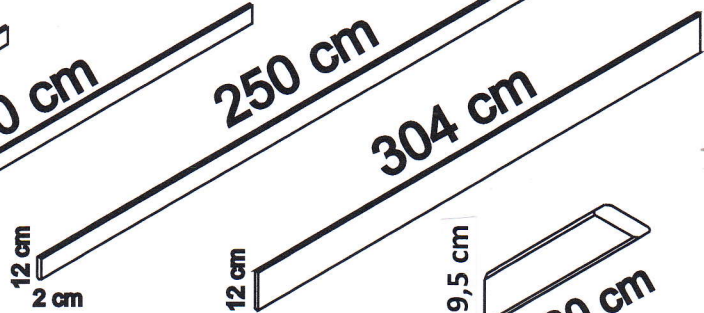

④ x4 pcs



⑤ x1 pcs

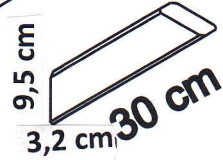

⑥ x10 pcs

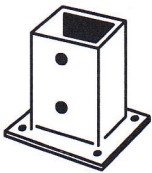

⑦ x6 pcs

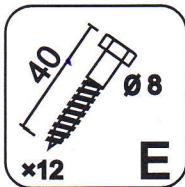
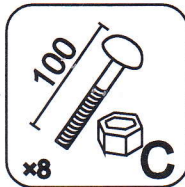
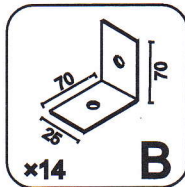

Prévoir pour le montage:



min 2 Personnes

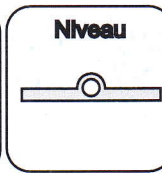

Niveau



Préperçage
ou vissage

X → φ4
Z → φ9
Y → PZ 2 x 25mm

ATTENTION: effectuer un pré-perçage des pièces afin d'éviter que le bois se fendent

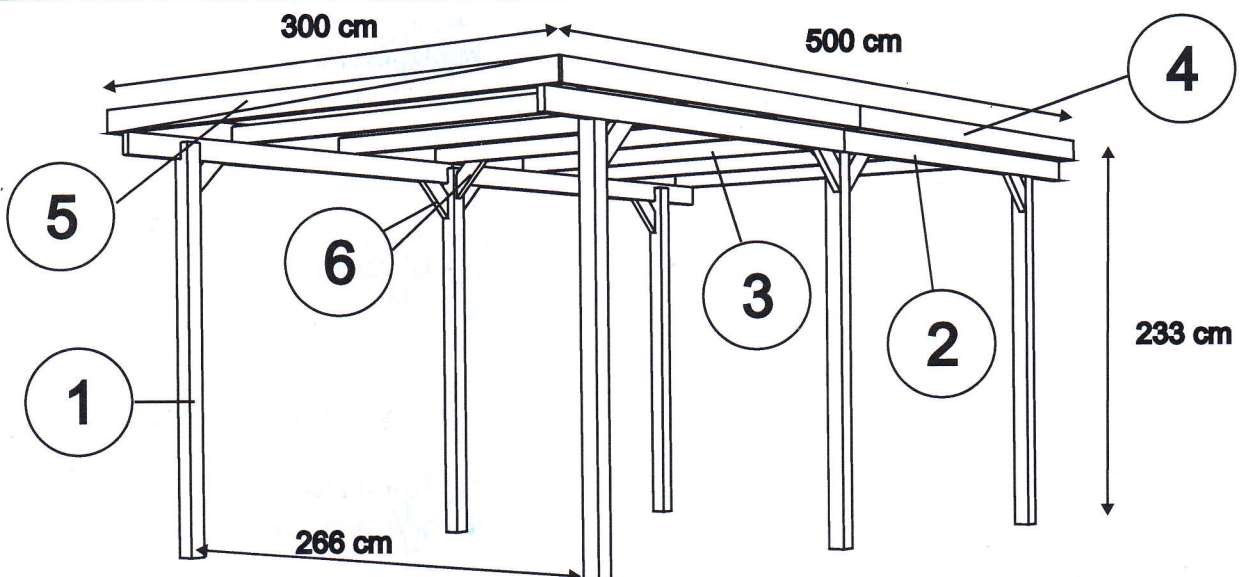

Le montage reste à la charge du client et sous sa responsabilité à ses risques et périls.
En aucun cas la société de distribution ou le fabricant ne peut être tenu responsable de quelque incident que ce soit.

1

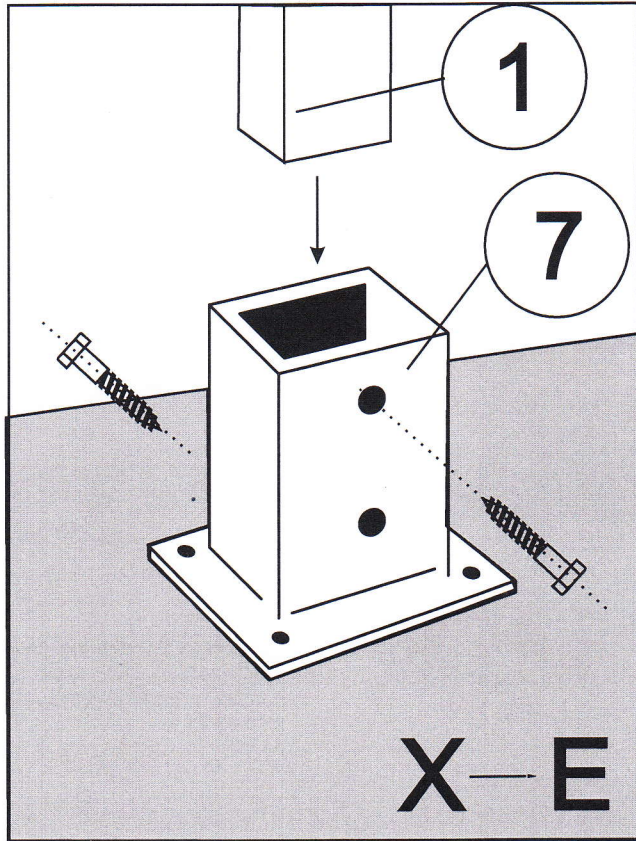
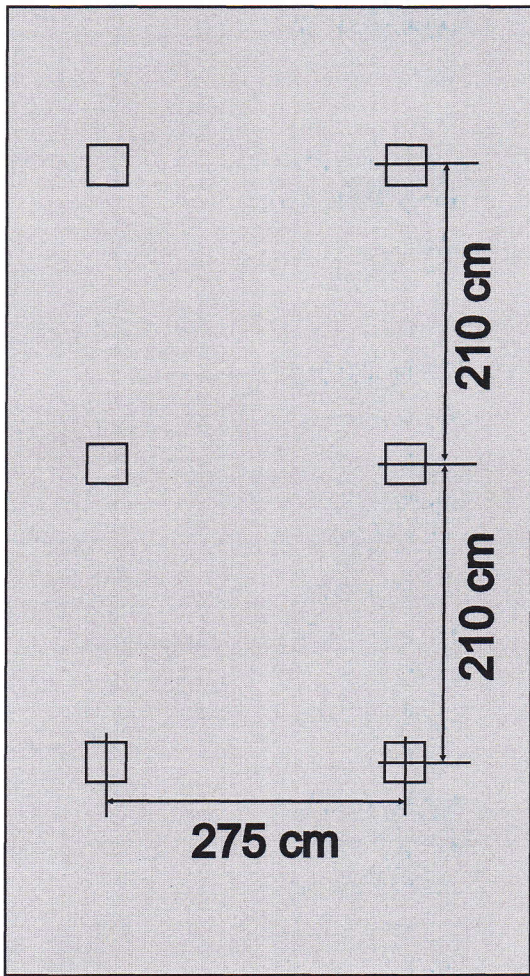

La visserie pour la fixation des platines sur le béton n'est pas fournie

2

