

GREEN OUTSIDE

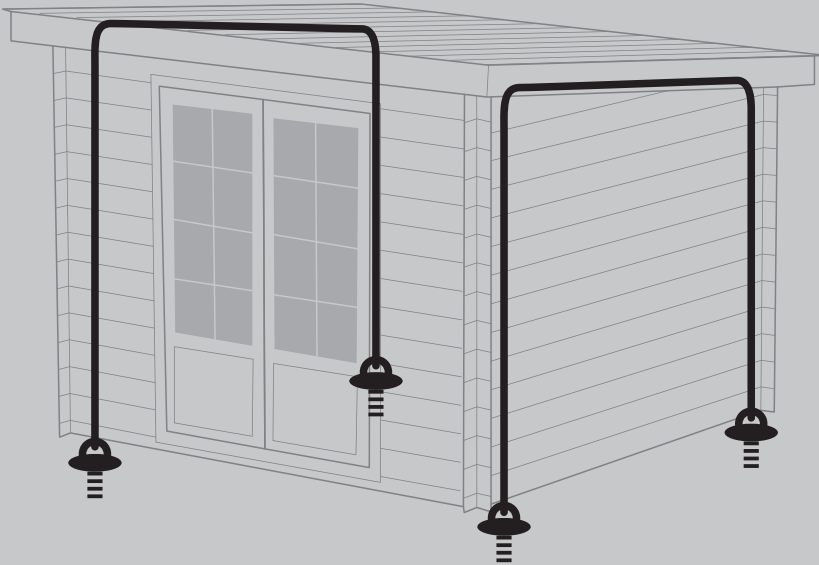

KIT ANCRAGE

Notice réalisée sur la base de l'abri 3x3 PLAT (toit monopente).
Kit compatible abri 3x6 PLAT, 3x3 TRADI (toit 2 pentes) et 3x6 TRADI .

IMPORTANT, À CONSERVER POUR CONSULTATION ULTÉRIEURE À LIRE ATTENTIVEMENT



30mn



x2



x6



x4



x4



x4



x4



x6



M8

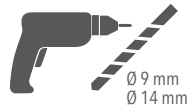

Ø 9 mm
Ø 14 mm



montage illustré pour l'abri au toit monopente
le principe est le même pour l'abri 2 pentes

L'installation des produits Green Outside sont sous votre responsabilité : Utiliser des outils adaptés, et équipez-vous des protections nécessaires (risque de coupure...). Ne pas installer en cas de vent ou de pluie. Les recommandations de prudence et de sécurité sont à mettre en œuvre pour tout travail en hauteur. Visuels non contractuels.

Pour nous contacter en cas de besoin : sav@green-outside.com

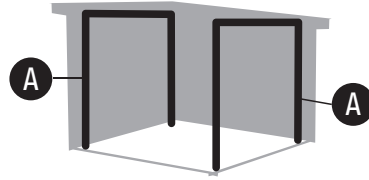
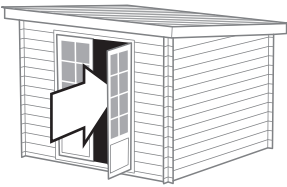

A

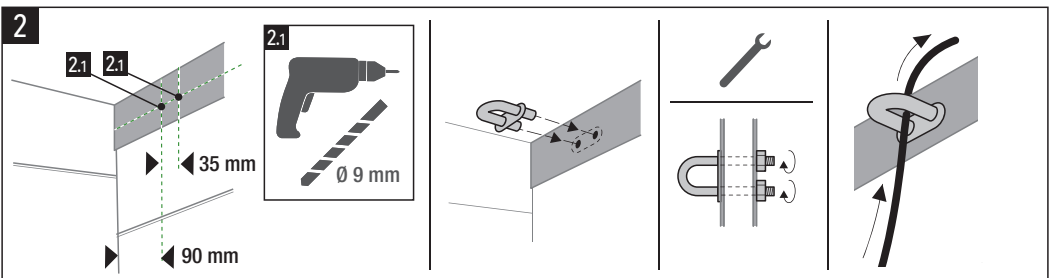
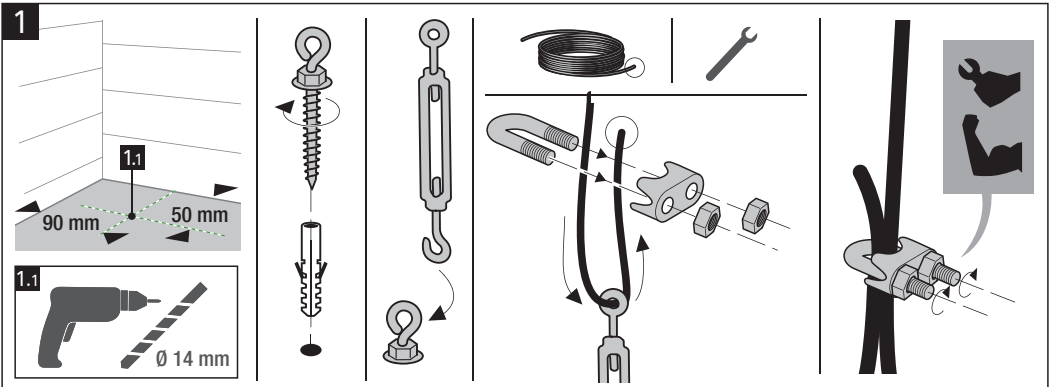
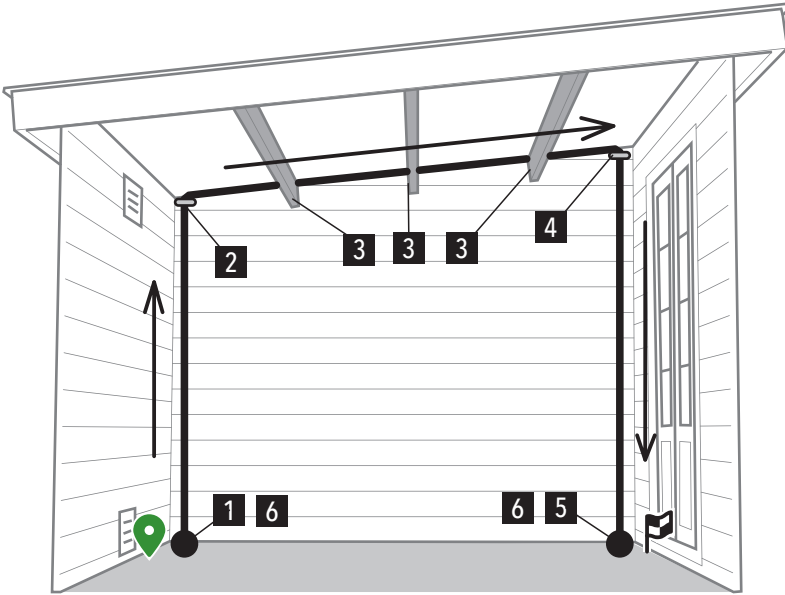

3

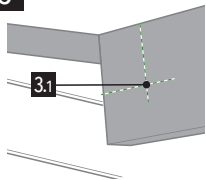

3.1

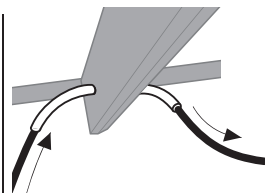
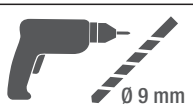

4

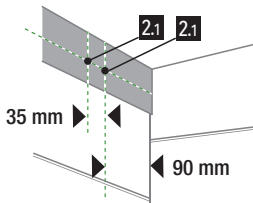

2.1

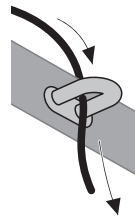
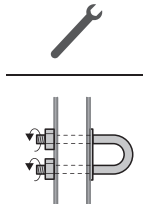
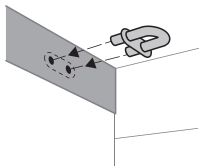

5

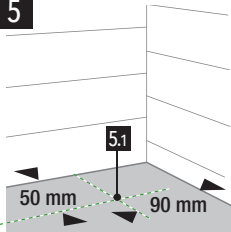

5.1

5.1

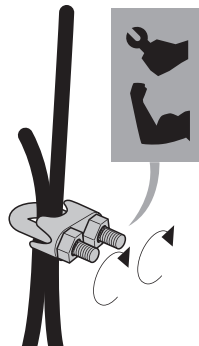
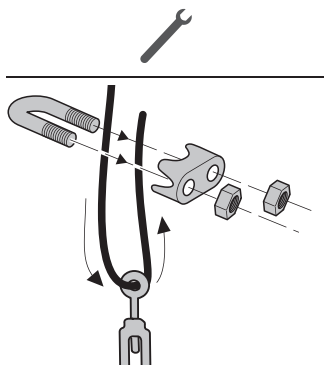
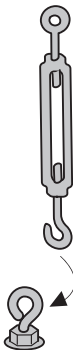

6

