

**ATTENTION!!!**  
pour éviter d'abimer vos  
pièces de bois, il faut les  
pré-percer avant de visser

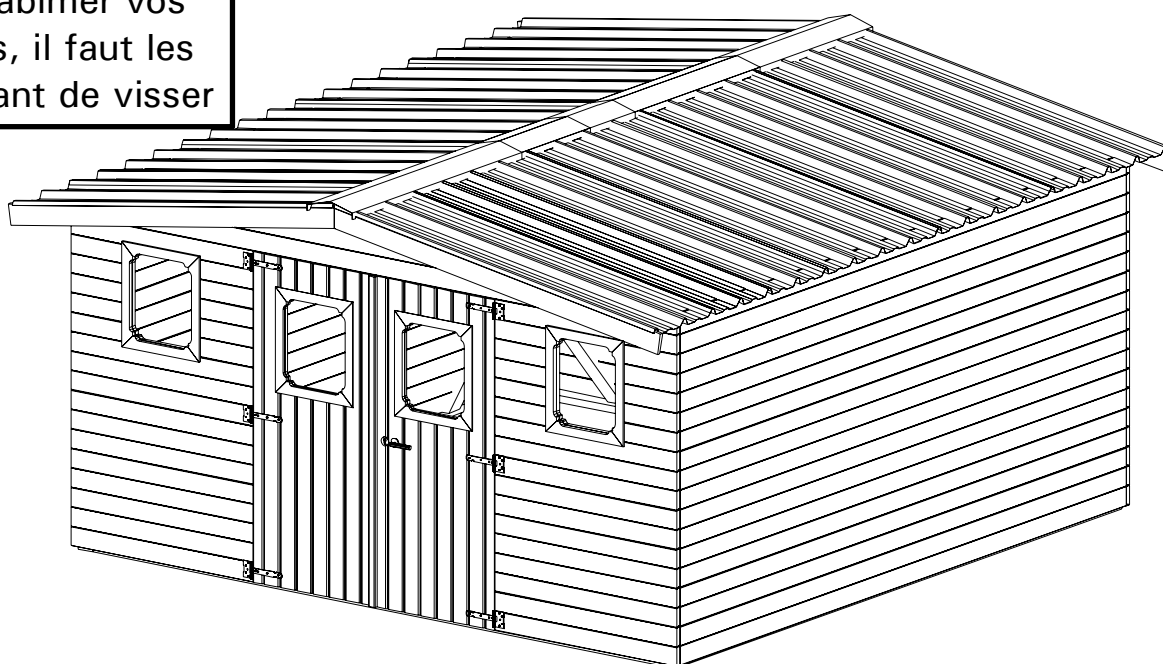

ø8 mm

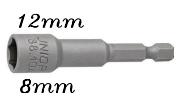
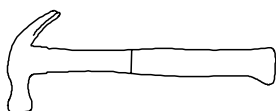

ø3 mm

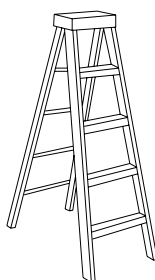
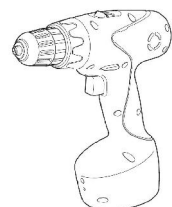

Les dimensions données sur le plan de soubassement sont les dimensions de la dalle béton à réaliser sur un sol parfaitement plat sans aucun autre objet extérieur type mur, clôture ou arbre dans l'entourage de la dalle. Si le produit est implanté près d'un mur, d'une haie ou d'un arbre il est nécessaire de l'éloigner des éléments extérieurs afin de pouvoir facilement le monter et l'entretenir. Nous nous dégageons de toute responsabilité en cas de mauvaise interprétation des dimensions de la dalle.



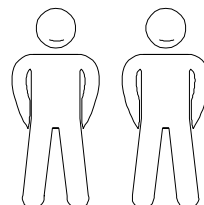





Le dimensioni del piano di base sono le dimensioni della soletta di cemento da realizzare su un terreno perfettamente piatto, senza alcun altro oggetto esterno, come un muro, una recinzione o un albero in prossimità delle solette. Se il prodotto è installato vicino ad una parete, un recinto o un albero, è necessario distanziarlo adeguatamente, in modo da poterlo facilmente montare e farne la manutenzione. Non ci assumiamo alcuna responsabilità per l'errata interpretazione delle dimensioni delle lastra.

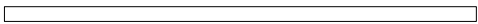
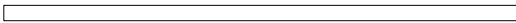

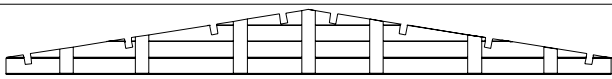
Nous garantissons la fourniture des pièces détachées durant 2 ans à compter de l'achat du produit.

Vérifier que vous avez bien toutes les pièces avant d'effectuer le montage

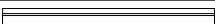
Demande sav

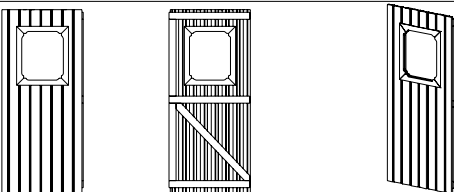
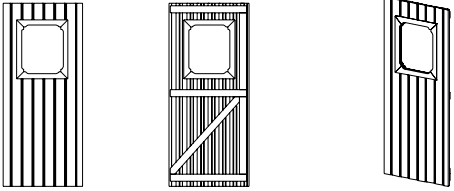
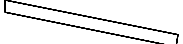
| Réf. | Qté. | Dessin pièce  | Dimensions<br>(en mm) |    |      | Observation | Qté. |
|------|------|---|-----------------------|----|------|-------------|------|
| 1    | 2    |    | 95                    | 38 | 3754 |             |      |
| 2    | 2    |    | 95                    | 38 | 3944 |             |      |
| 3    | 6    |    | 95                    | 45 | 1900 |             |      |
| 4    | 8    |    | 95                    | 45 | 4480 |             |      |
| 5    | 2    |    | 427                   | 46 | 4000 |             |      |
| 6    | 17   |    | 117                   | 28 | 4000 |             |      |
| 7    | 36   |    | 117                   | 28 | 3944 |             |      |
| 8    | 24   |    | 117                   | 28 | 1200 |             |      |
| 9    | 20   |    | 117                   | 28 | 384  |             |      |
| 10   | 2    |    | 580                   | 54 | 510  |             |      |
| 11   | 8    |    | 45                    | 45 | 900  |             |      |
|      |      |   |                       |    |      |             |      |
| 12   | 1    |  | 807                   | 38 | 1815 |             |      |
| 13   | 1    |  | 792                   | 38 | 1815 |             |      |
| 14   | 4    |  | 95                    | 19 | 2180 |             |      |

A compléter impérativement pour toute demande SAV et à envoyer par mail à  
sav@foresta.fr + photo des pièces abîmées

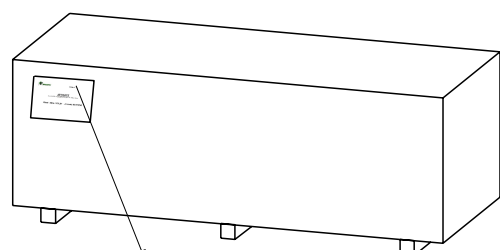

Colis n°: \_\_\_\_\_

THA4040.02T

Colis n°: \_\_\_\_\_

NOM DU MAGASIN  
(où l'abri a été acheté)

NOM DU CLIENT











PRENOM DU CLIENT

N° de téléphone

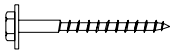
Nous garantissons la fourniture des pièces détachées durant 2 ans à compter de l'achat du produit.

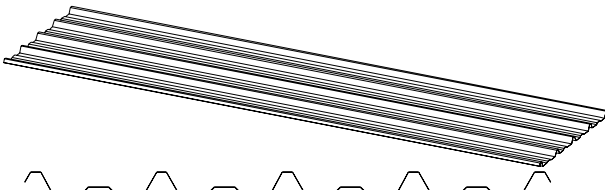
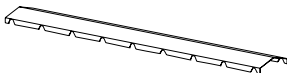
Vérifier que vous avez bien toutes les pièces avant d'effectuer le montage

Demande sav

| Réf. | Qté. | Dessin pièce  | Dimensions (en mm) |       |      | Observation | Qté. |
|------|------|---|--------------------|-------|------|-------------|------|
|      |      |   |                    |       |      |             |      |
| q1   | 20   |    |                    | ø 8   | 110  |             |      |
| q2   | 300  |    |                    | ø 5   | 60   |             |      |
| q3   | 130  |    |                    | ø 4   | 40   |             |      |
| q4   | 20   |    |                    | ø 3.5 | 30   |             |      |
| q5   | 6    |    |                    |       |      |             |      |
| q6   | 110  |    |                    | ø6.5  | 100  |             |      |
| q7   | 110  |    | 38                 | 12    | 40   |             |      |
| q8   | 60   |   |                    | ø4.8  | 20   |             |      |
| q9   | 10   |  | 1000               | 40    | 2140 |             |      |
| q10  | 3    |  |                    |       | 2150 |             |      |
| q11  | 6    |  |                    |       |      |             |      |
| q12  | 2    |  |                    |       |      |             |      |
| q13  | 1    |  |                    |       |      |             |      |

A compléter impérativement pour toute demande SAV et à envoyer par mail à [sav@foresta.fr](mailto:sav@foresta.fr) + photo des pièces abîmées

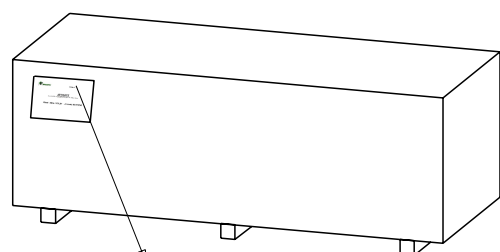

Colis n°: \_\_\_\_\_

THA4040.02T

Colis n°: \_\_\_\_\_

NOM DU MAGASIN  
(où l'abri a été acheté)

NOM DU CLIENT

PRENOM DU CLIENT

N° de téléphone

Plan de soubassement

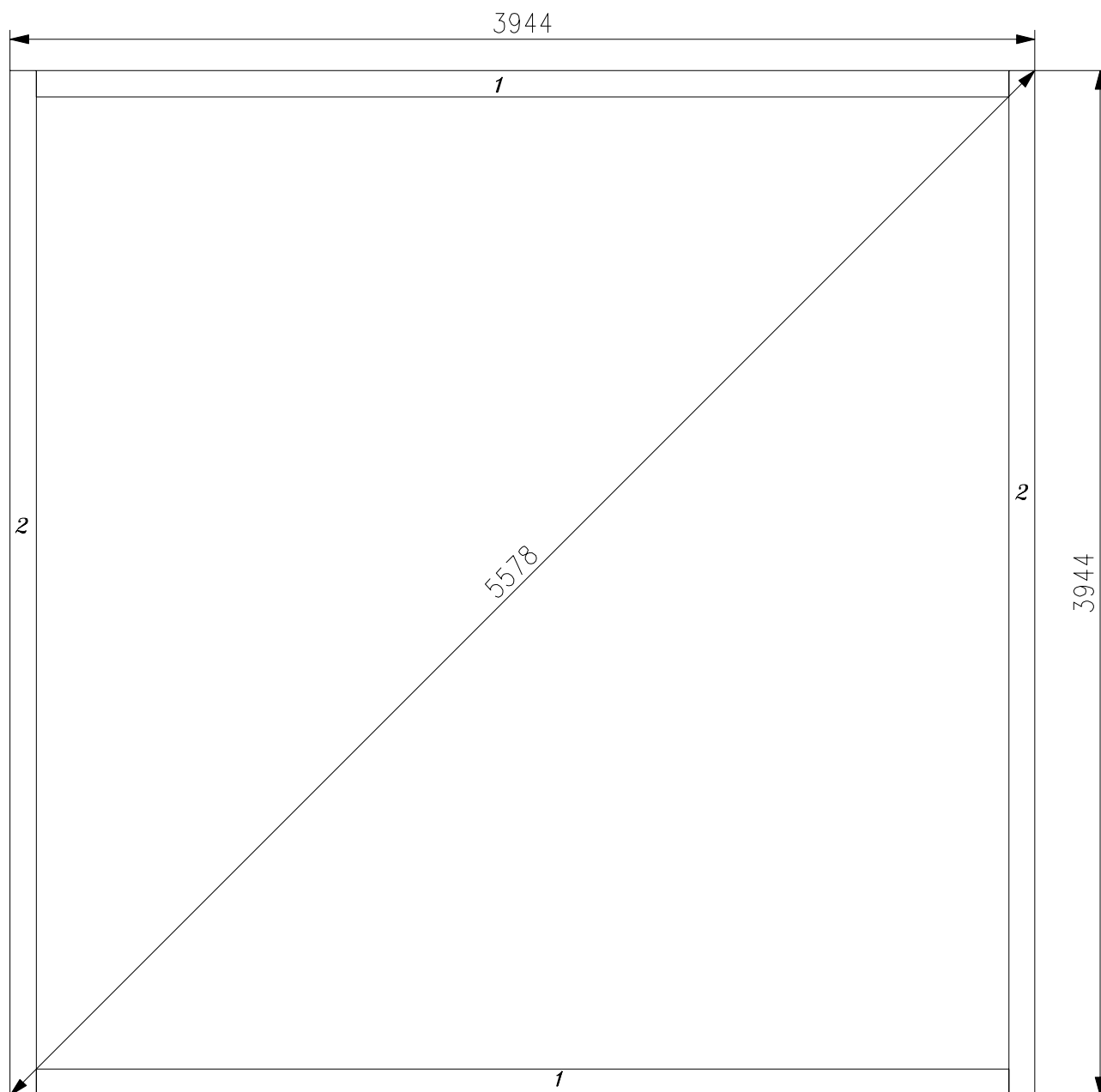

q1

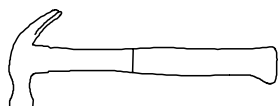

Tolérances à respecter (selon DTU 31.2):

- longueur et largeur:  $\pm 0,01\text{m}$ ;
- équerage:  $\pm 0,01\text{m}$  mesuré sur 10m;
- arase:  $\pm 0,01\text{m}$  sur une longueur de 10 mètres linéaires alignés ou non et de  $\pm 2\text{mm}$  par mètre linéaire;
- rectitude de bords en plan:  $\pm 5\text{mm}$  .

Les dimensions données sur le plan de soubassement sont les dimensions de la dalle béton à réaliser sur un sol parfaitement plat sans aucun autre objet extérieur type mur, clôture ou arbre dans l'entourage de la dalle. Si le produit est implanté près d'un mur, d'une haie ou d'un arbre il est nécessaire de l'éloigner des éléments extérieurs afin de pouvoir facilement le monter et l'entretenir. Nous nous dégageons de toute responsabilité en cas de mauvaise interprétation des dimensions de la dalle.

Le dimensioni del piano di base sono le dimensioni della soletta di cemento da realizzare su un terreno perfettamente piatto, senza alcun altro oggetto esterno, come un muro, una recinzione o un albero in prossimità della soletta. Se il prodotto è installato vicino ad una parete, un recinto o un albero, è necessario distanziarlo adeguatamente, in modo da poterlo facilmente montare e farne la manutenzione. Non ci assumiamo alcuna responsabilità per l'errata interpretazione delle dimensioni delle lastra.

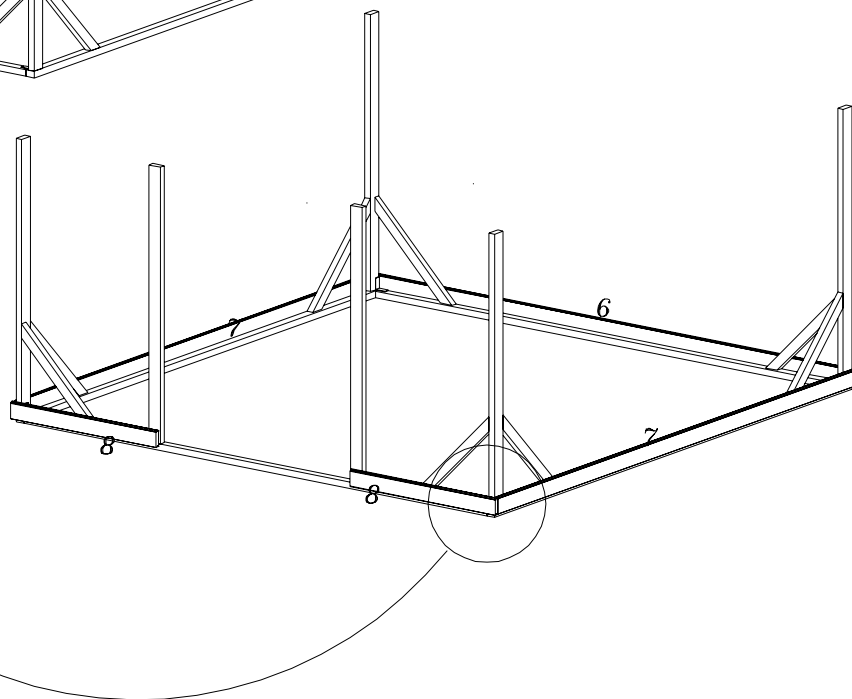
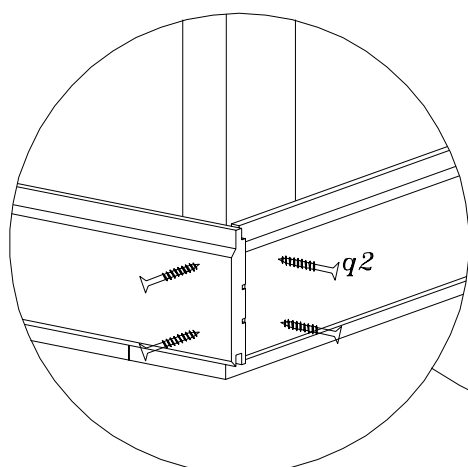
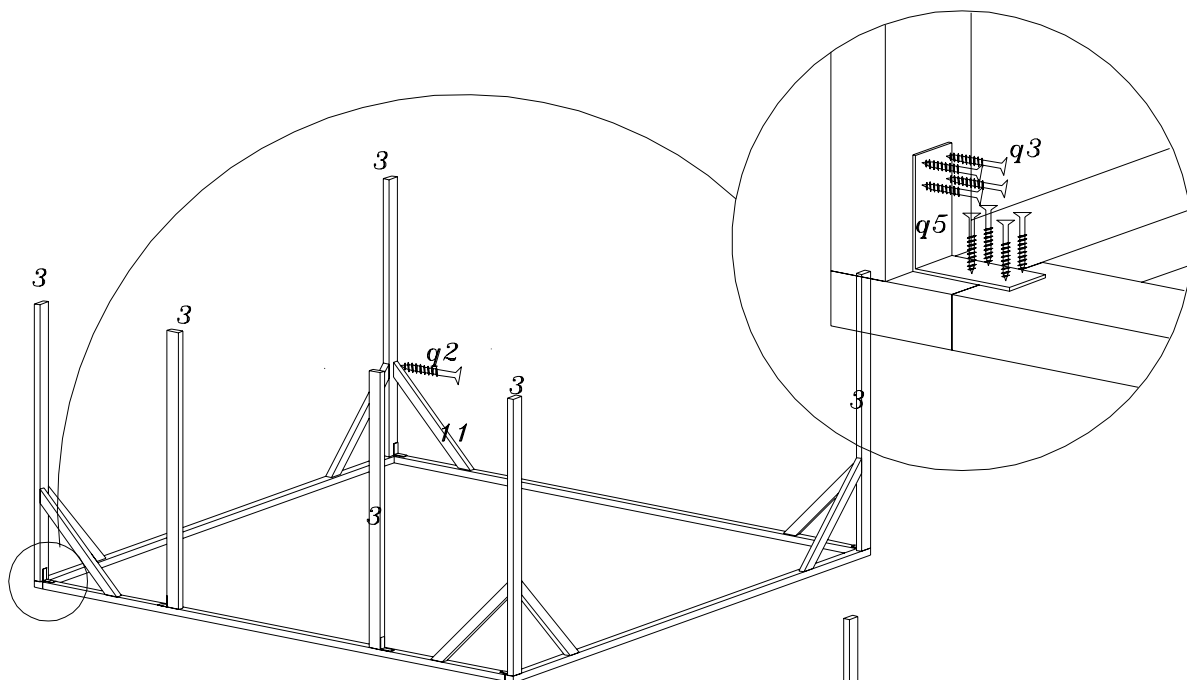

**ATTENTION!!!**  
pour éviter d'abimer vos  
pièces de bois, il faut les  
pré-percer avant de visser

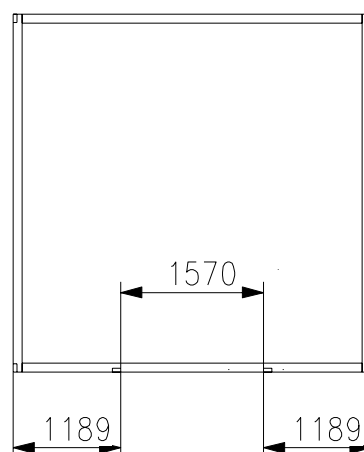
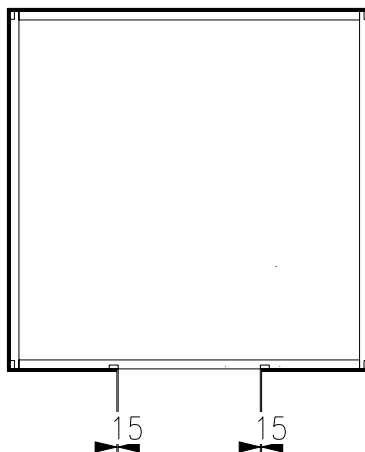
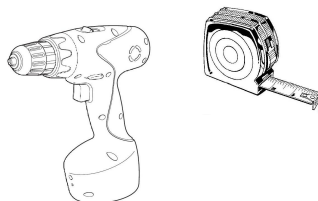

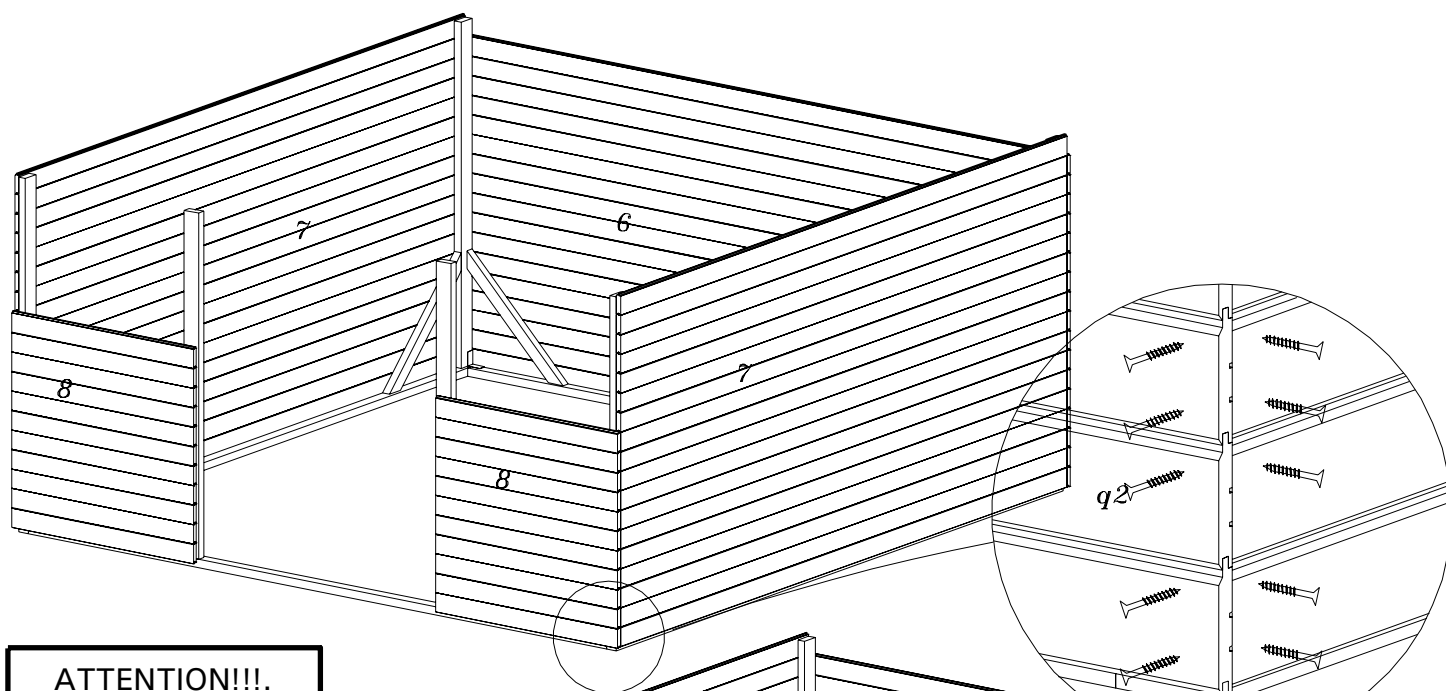

**ATTENTION!!!**  
pour éviter d'abimer vos  
pièces de bois, il faut les  
pré-percer avant de visser

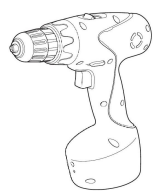
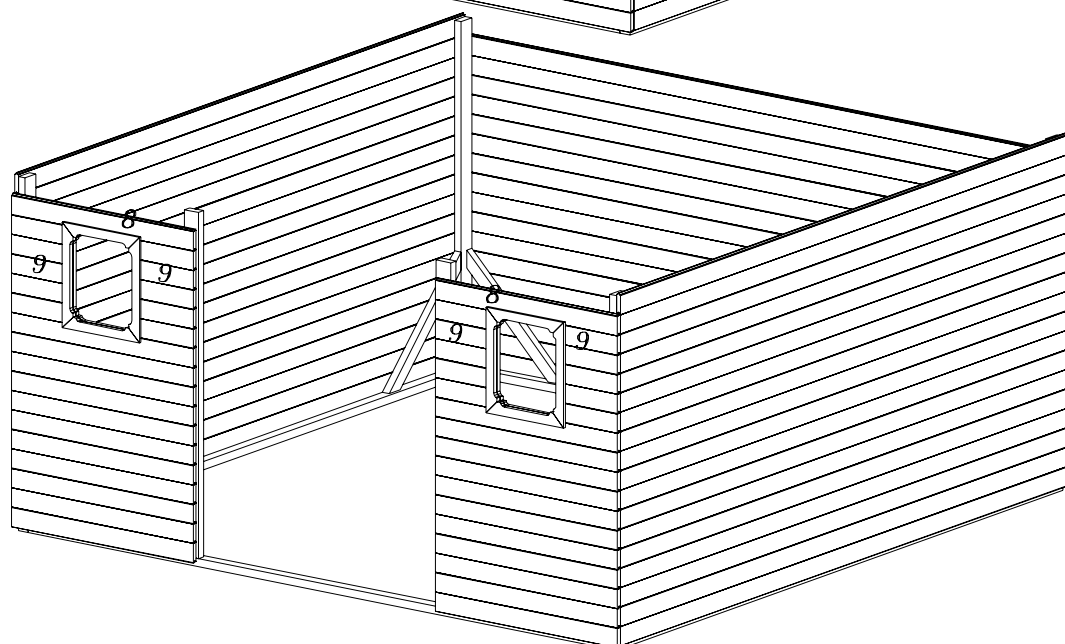
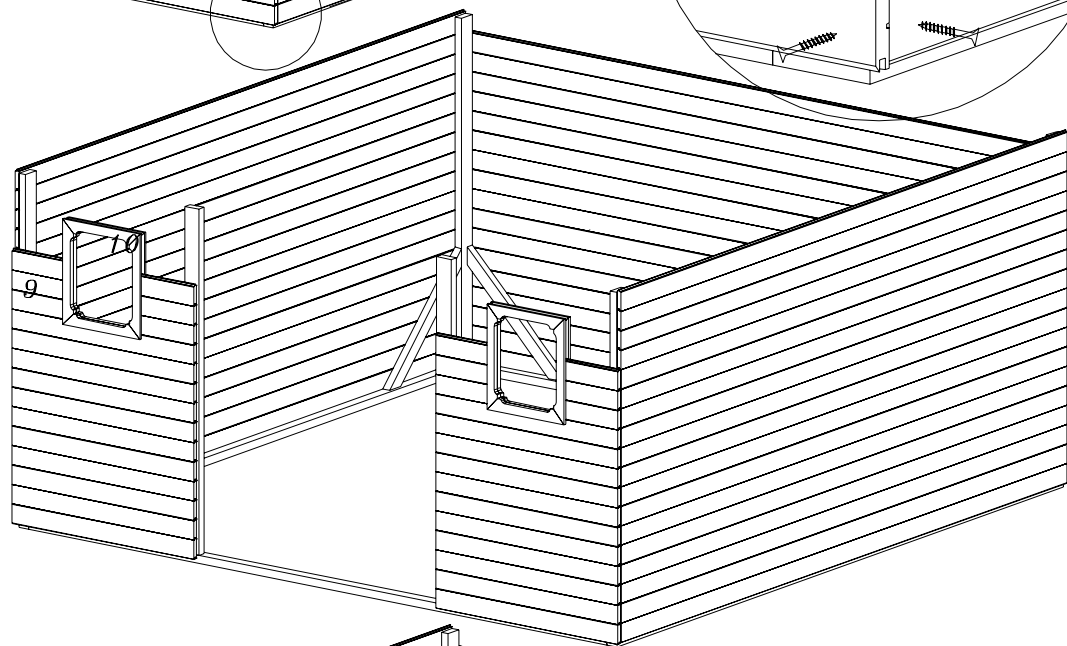

Ø3 mm

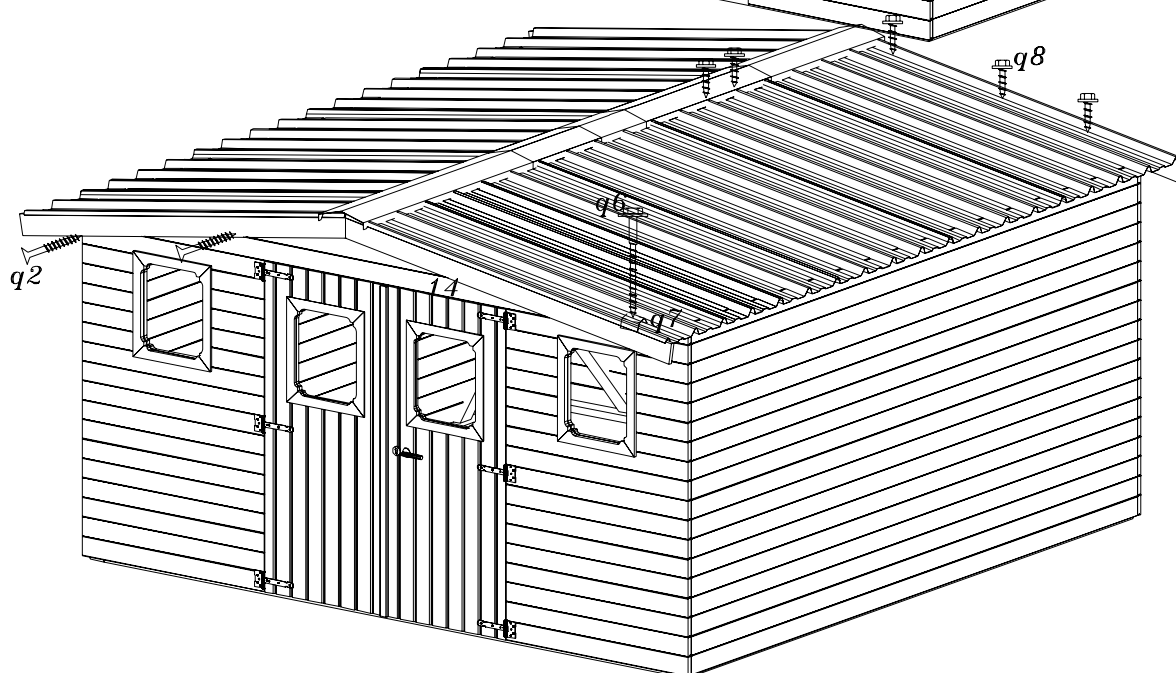
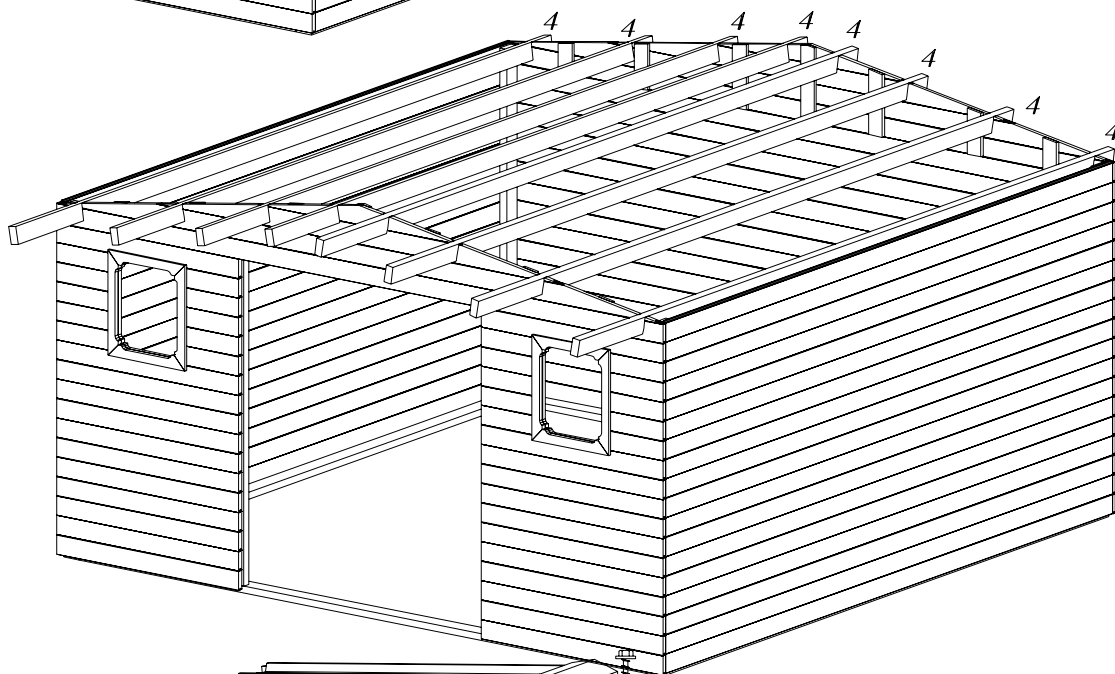
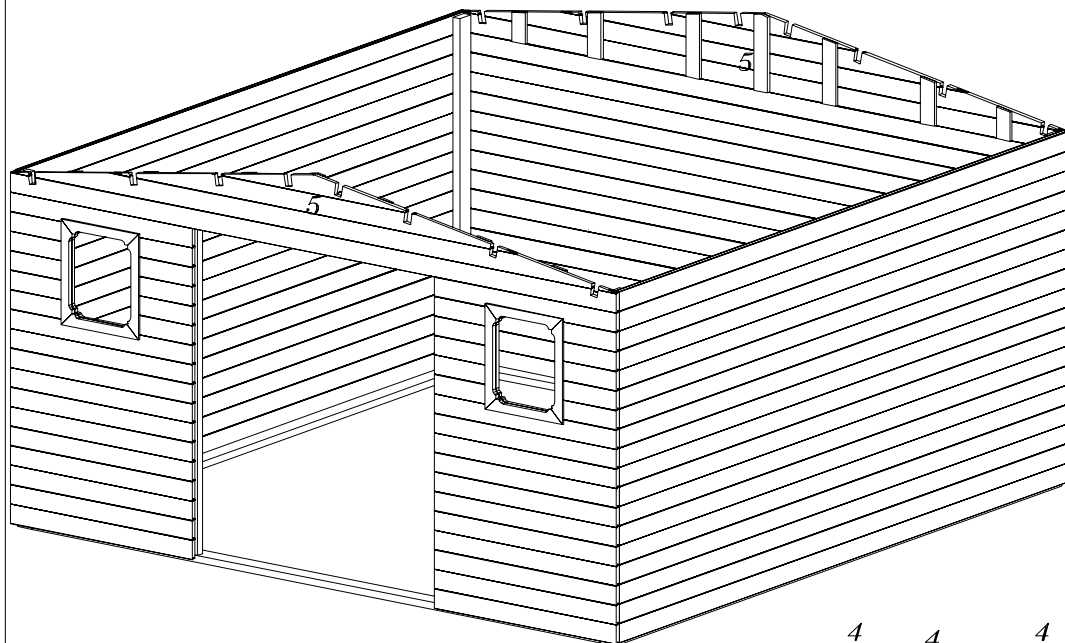

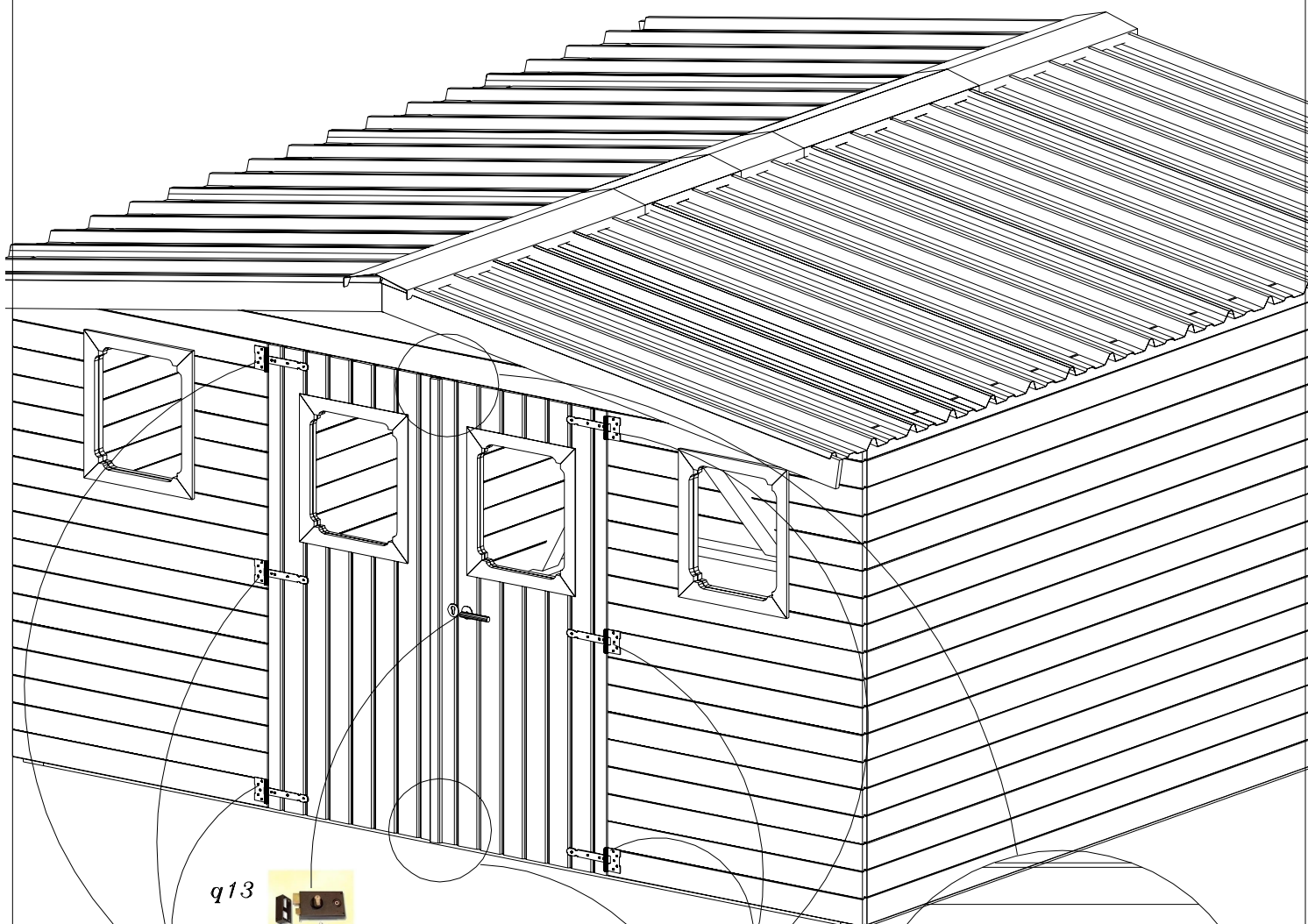

q13

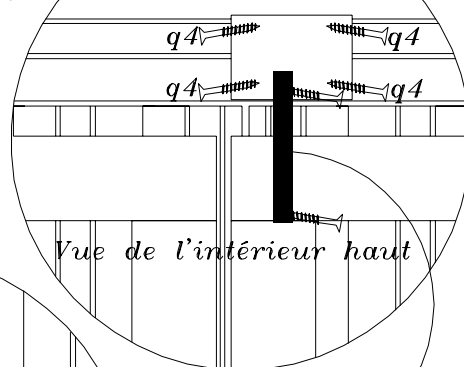
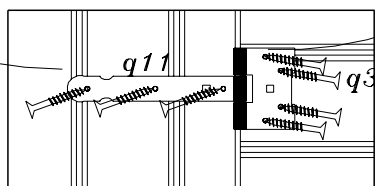

Vue de l'intérieur haut

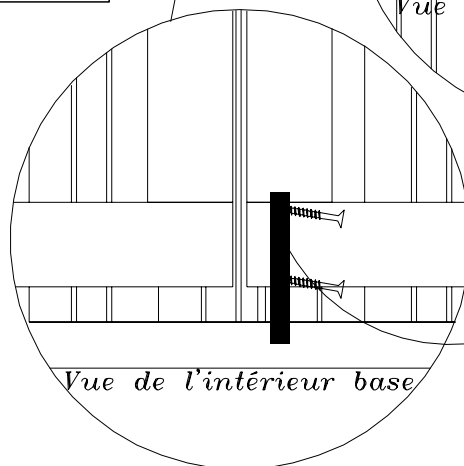

Vue de l'intérieur base



q12

