

ATTENTION!!!.
pour éviter d'abimer vos
pièces de bois, il faut les
pré-percer avant de visser

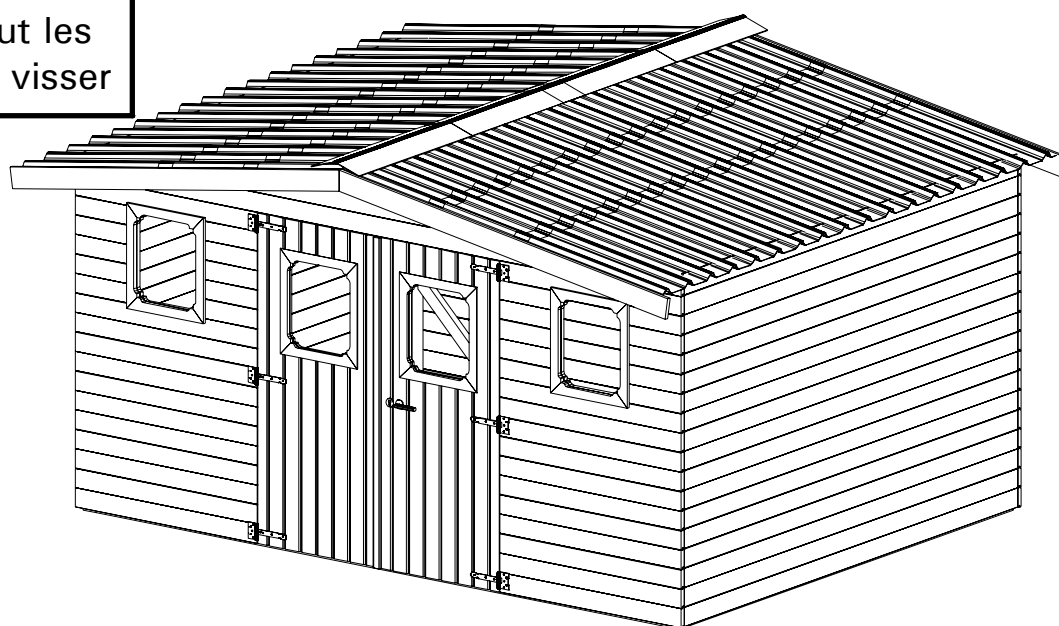

ø8 mm

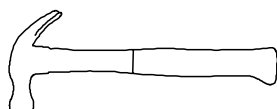

ø3 mm

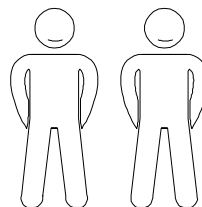
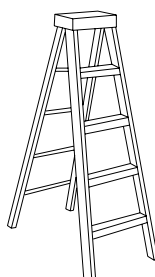
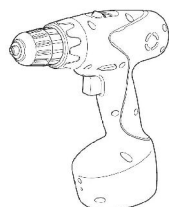









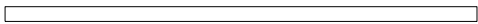
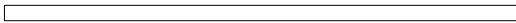

Les dimensions données sur le plan de soubassement sont les dimensions de la dalle béton à réaliser sur un sol parfaitement plat sans aucun autre objet extérieur type mur, clôture ou arbre dans l'entourage de la dalle. Si le produit est implanté près d'un mur, d'une haie ou d'un arbre il est nécessaire de l'éloigner des éléments extérieurs afin de pouvoir facilement le monter et l'entretenir. Nous nous dégageons de toute responsabilité en cas de mauvaise interprétation des dimensions de la dalle.

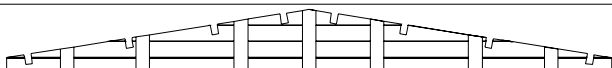
Le dimensioni del piano di base sono le dimensioni della soletta di cemento da realizzare su un terreno perfettamente piatto, senza alcun altro oggetto esterno, come un muro, una recinzione o un albero in prossimità delle soletta. Se il prodotto è installato vicino ad una parete, un recinto o un albero, è necessario distanziarlo adeguatamente, in modo da poterlo facilmente montare e farne la manutenzione. Non ci assumiamo alcuna responsabilità per l'errata interpretazione delle dimensioni delle lastra.

Nous garantissons la fourniture des pièces détachées durant 2 ans à compter de l'achat du produit.

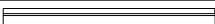
Vérifier que vous avez bien toutes les pièces avant d'effectuer le montage

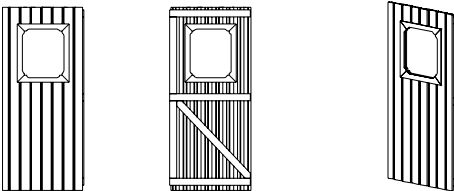
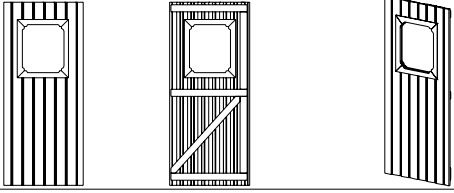
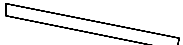
Demande sav

Réf.	Qté.	Dessin pièce	Dimensions (en mm)			Observation	Qté.
1	2		95	38	3754		
2	2		95	38	2944		
3	6		95	45	1900		
4	8		95	45	3480		
5	2		427	46	4000		
6	17		115	28	4000		
7	36		115	28	2944		
8	24		115	28	1200		
9	20		115	28	384		
10	2		580	54	510		
11	1		807	38	1815		
12	1		792	38	1815		
13	4		95	20	2180		
14	8		45	45	900		
15	1		40	20	1815		

A compléter impérativement pour toute demande SAV et à envoyer par mail à
sav@foresta.fr + photo des pièces abîmées

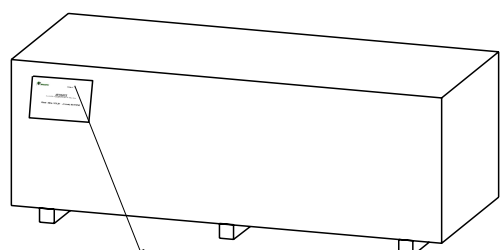

Colis n°: _____

THA4030.02N













Colis n°: _____

NOM DU MAGASIN
(où l'abri a été acheté)

NOM DU CLIENT

PRENOM DU CLIENT

N° de téléphone

					Demande sav	
Réf.	Qté.	Dessin pièce	Dimensions (en mm)		Observation	Qté.
q1	20			∅ 8	110	
q2	310			∅ 5	60	
q3	125			∅ 4	40	
q4	30			∅ 3.5	30	
q5	6					
q6	145			∅2.2	100	
q7	6 2		1080 500	40	998	
q8	12 4		1080 500	40	664	
q9	2		380	40	2000	
q11	40			∅2.2	20	
q12	6					
q13	2					
q14	1					

A compléter impérativement pour toute demande SAV et à envoyer par mail à sav@foresta.fr + photo des pièces abîmées

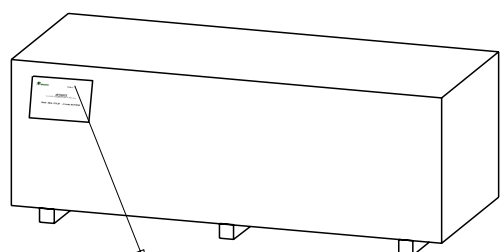

Colis n°: _____

THA4030.02N

Colis n°: _____

NOM DU MAGASIN
(où l'abri a été acheté)

NOM DU CLIENT

PRENOM DU CLIENT

N° de téléphone

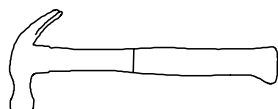
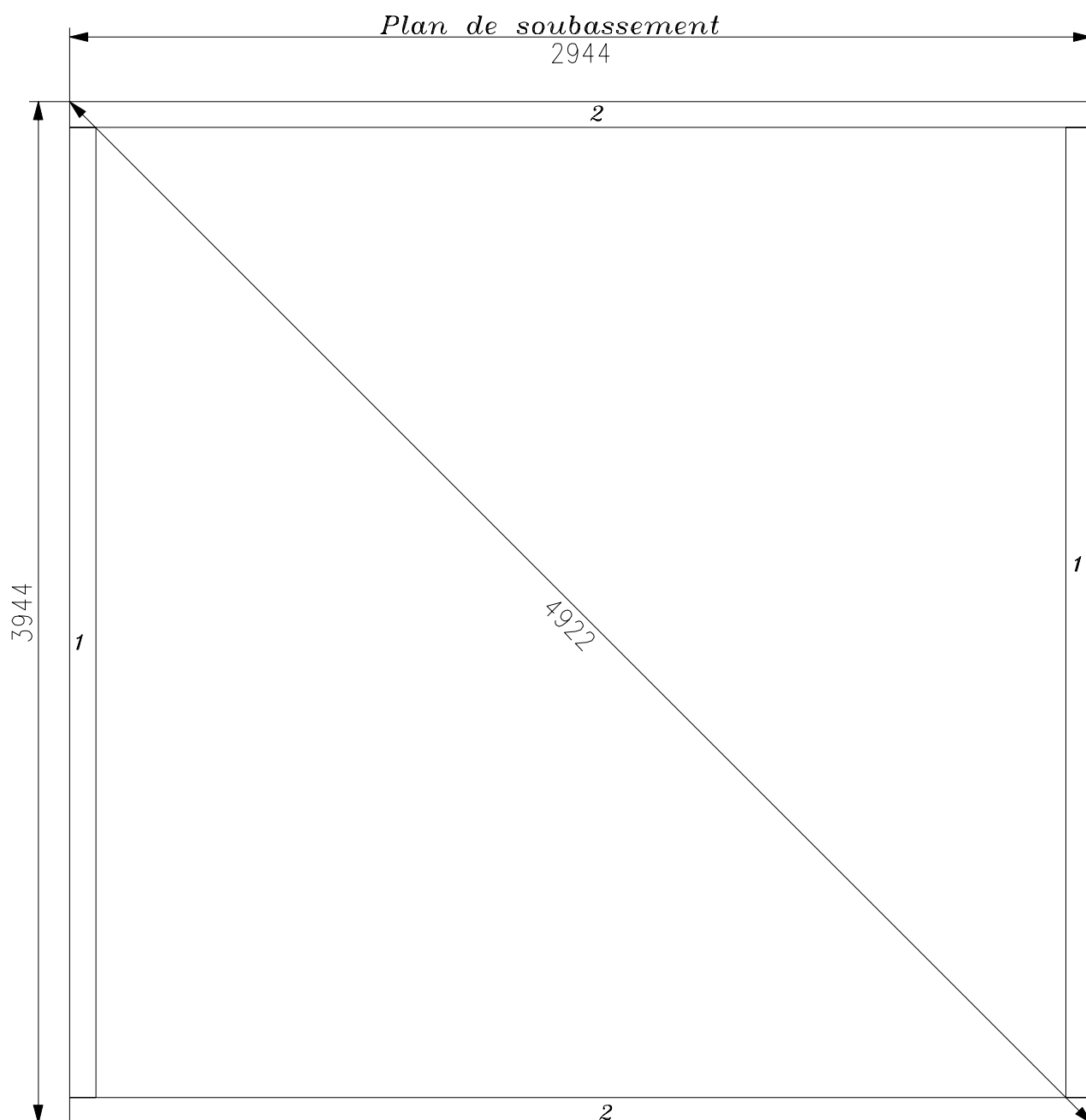

Tolérances à respecter (selon DTU 31.2):

- longueur et largeur: $\pm 0,01\text{m}$;
- équerrage: $\pm 0,01\text{m}$ mesuré sur 10m;
- arase: $\pm 0,01\text{m}$ sur une longueur de 10 mètres linéaires alignés ou non et de $\pm 2\text{mm}$ par mètre linéaire;
- rectitude de bords en plan: $\pm 5\text{mm}$.

Les dimensions données sur le plan de soubassement sont les dimensions de la dalle béton à réaliser sur un sol parfaitement plat sans aucun autre objet extérieur type mur, clôture ou arbre dans l'entourage de la dalle. Si le produit est implanté près d'un mur, d'une haie ou d'un arbre il est nécessaire de l'éloigner des éléments extérieurs afin de pouvoir facilement le monter et l'entretenir. Nous nous dégageons de toute responsabilité en cas de mauvaise interprétation des dimensions de la dalle.

Le dimensioni del piano di base sono le dimensioni della soletta di cemento da realizzare su un terreno perfettamente piatto, senza alcun altro oggetto esterno, come un muro, una recinzione o un albero in prossimità delle soletta. Se il prodotto è installato vicino ad una parete, un recinto o un albero, è necessario distanziarlo adeguatamente, in modo da poterlo facilmente montare e farne la manutenzione. Non ci assumiamo alcuna responsabilità per l'errata interpretazione delle dimensioni delle lastra.

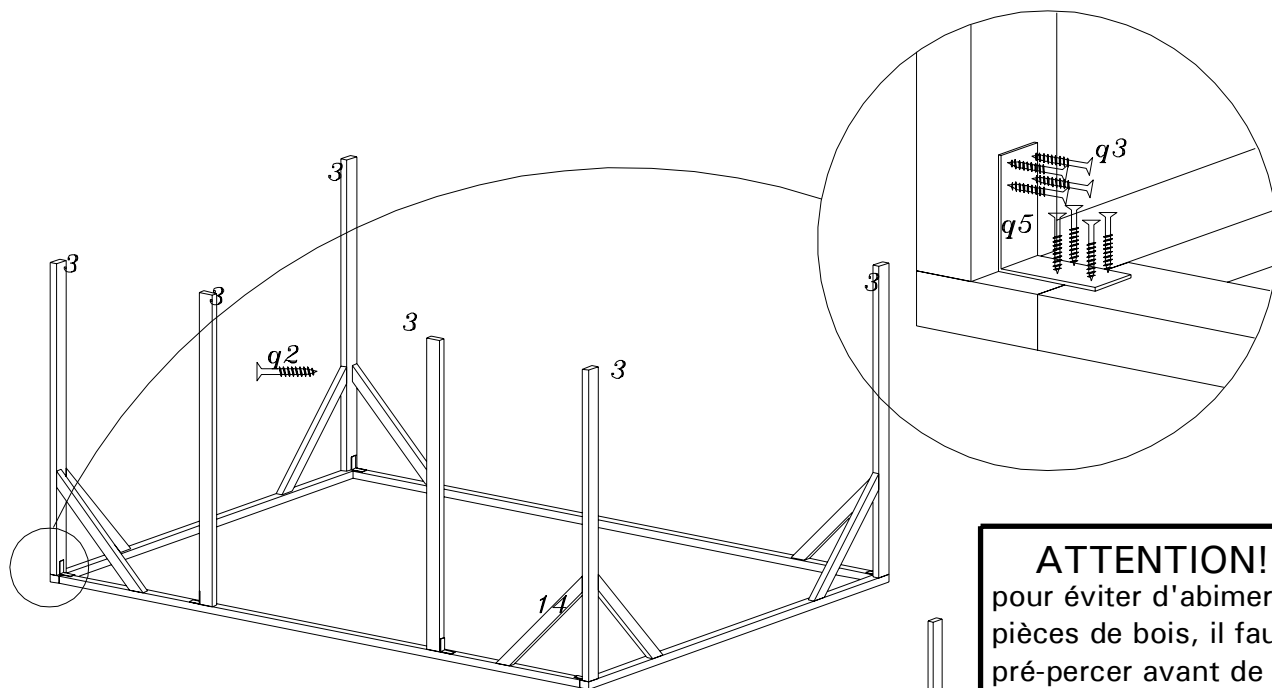

ATTENTION!!!
pour éviter d'abimer vos
pièces de bois, il faut les
pré-percer avant de visser

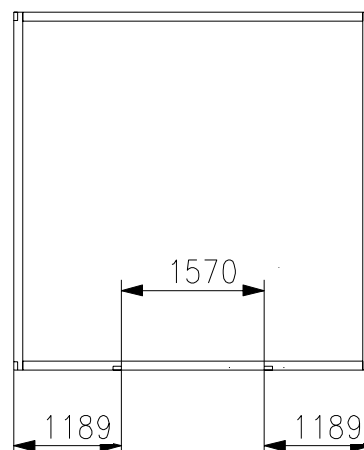
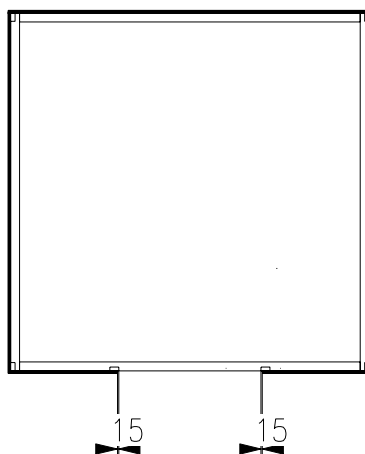
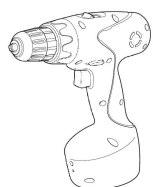
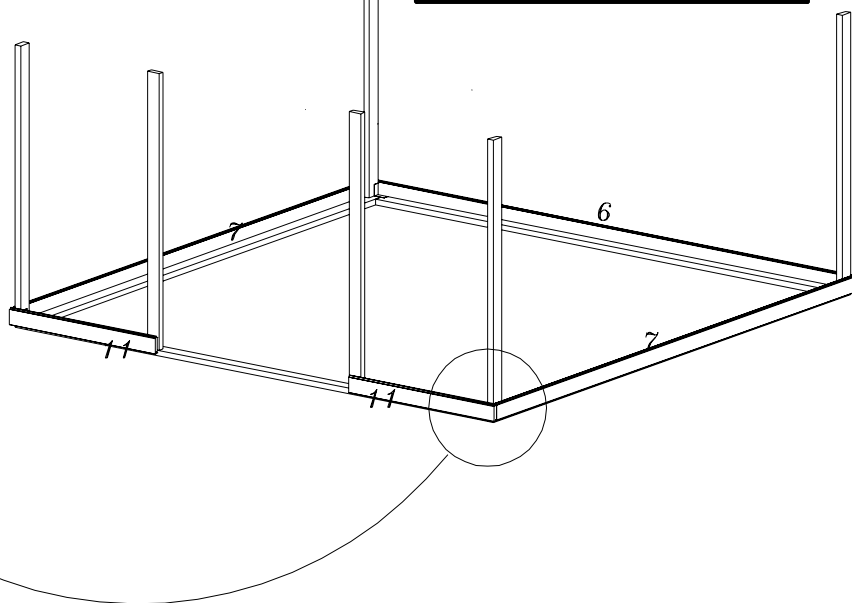
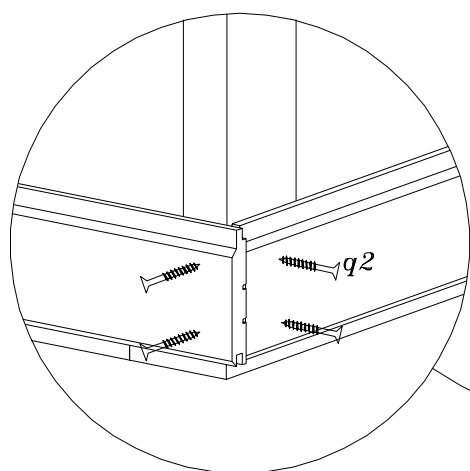

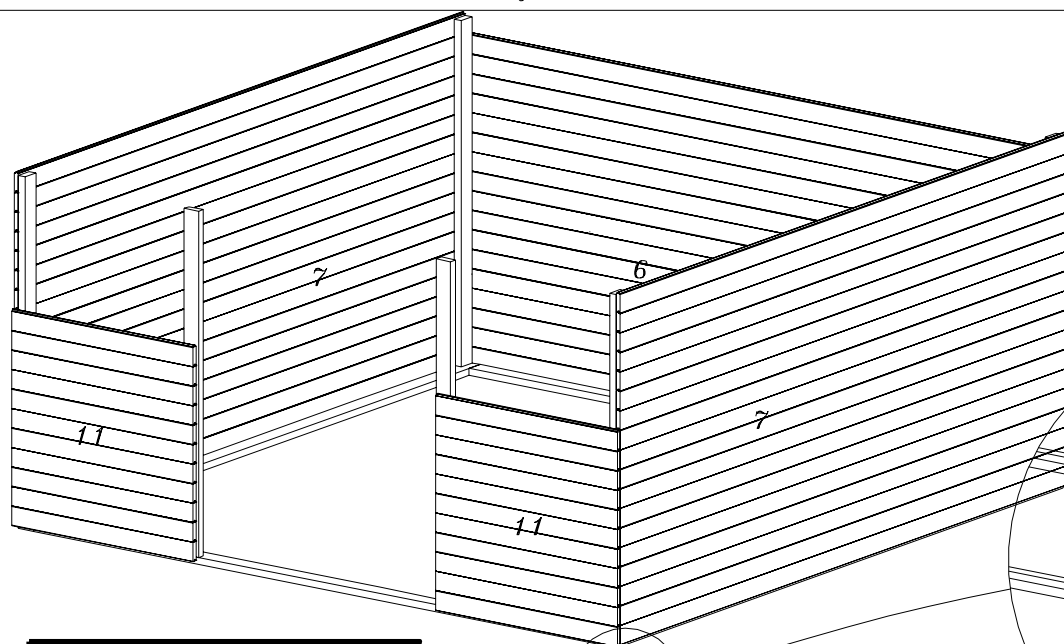

ATTENTION!!!
pour éviter d'abimer vos
pièces de bois, il faut les
pré-percer avant de visser

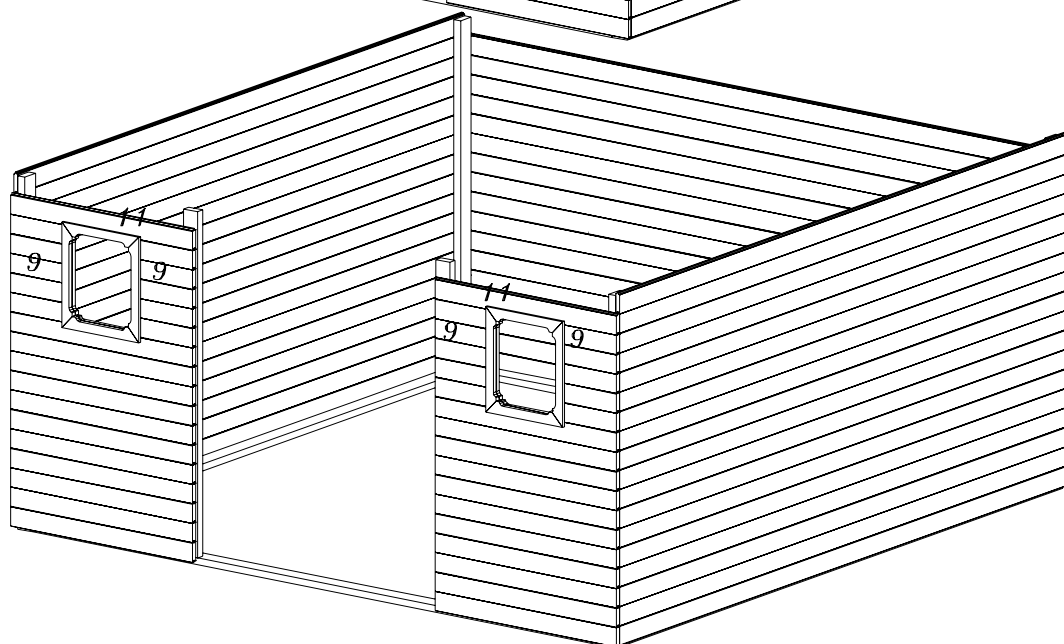
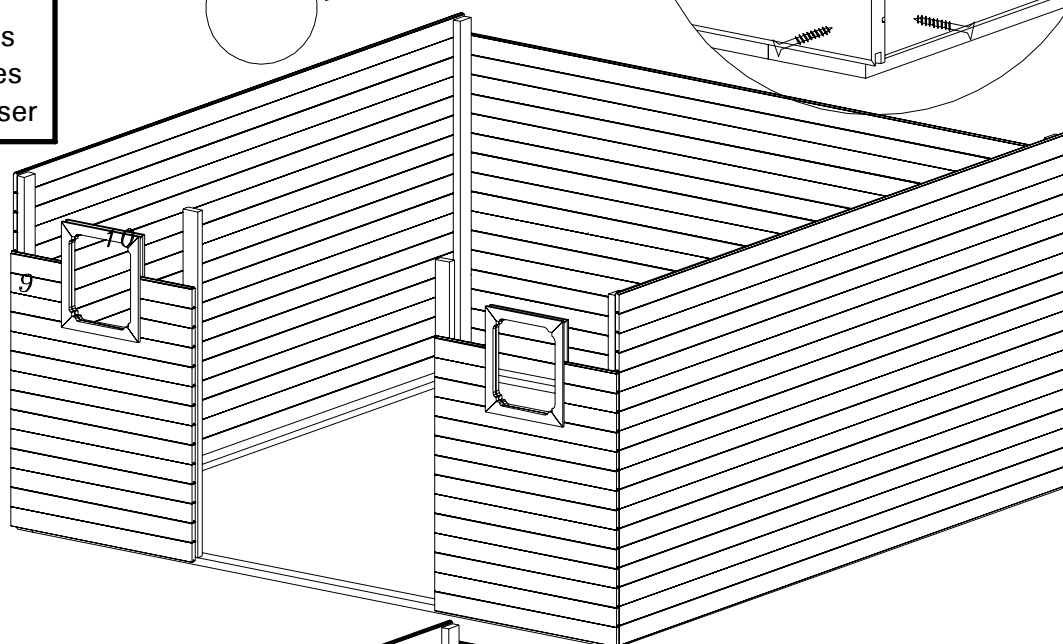

Ø3 mm



