

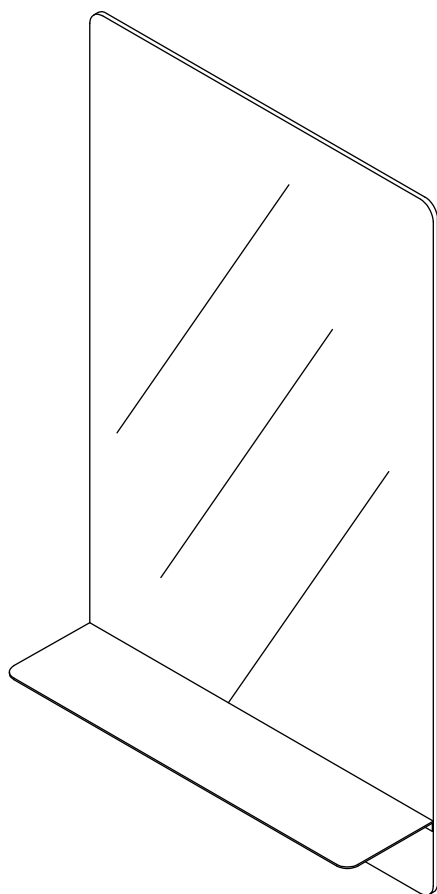

Miroir 40 cm avec tablette

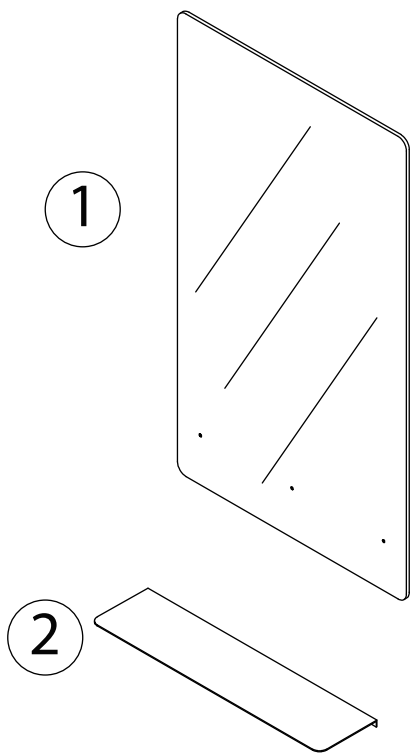
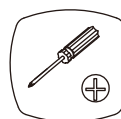
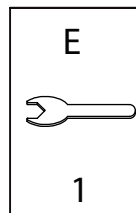
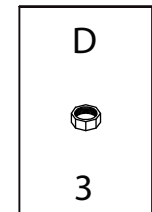
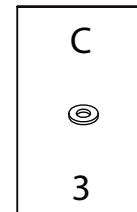
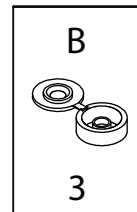
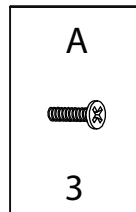

Pièce n °	Quantité	Désignation
-----------	----------	-------------

1	1	Miroir
2	1	Tablette métal



 **CHARGE MAX. 3 KG**

 **UTILISEZ LES VIS ET LES CHEVILLES ADAPTÉES A VOS MURS**

Attention !
Ce produit doit être fixé au mur.
Utilisez des vis adaptées au matériau de votre mur (non incluses).
En cas de doute, demandez conseil à un vendeur.



1

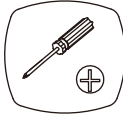
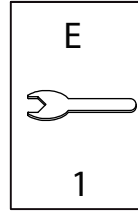
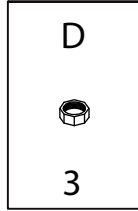
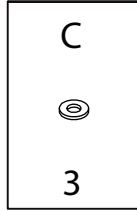
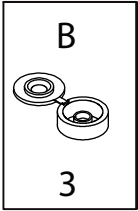
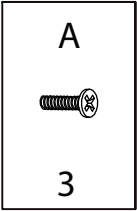

1

2

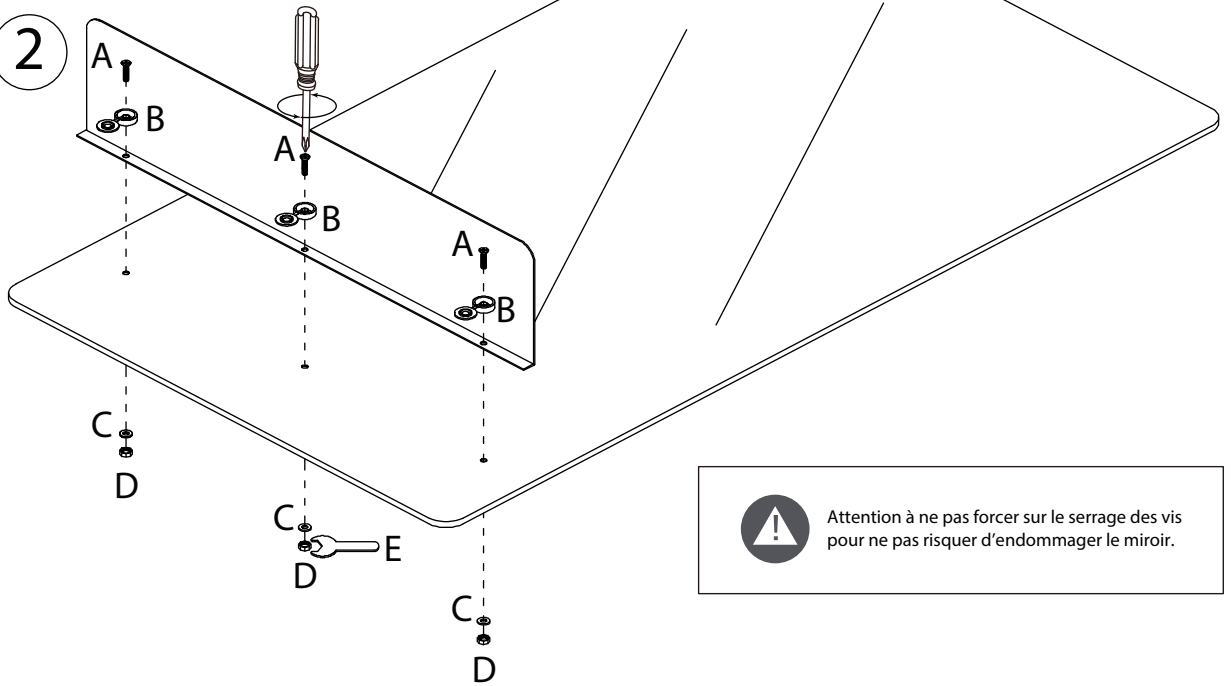

2

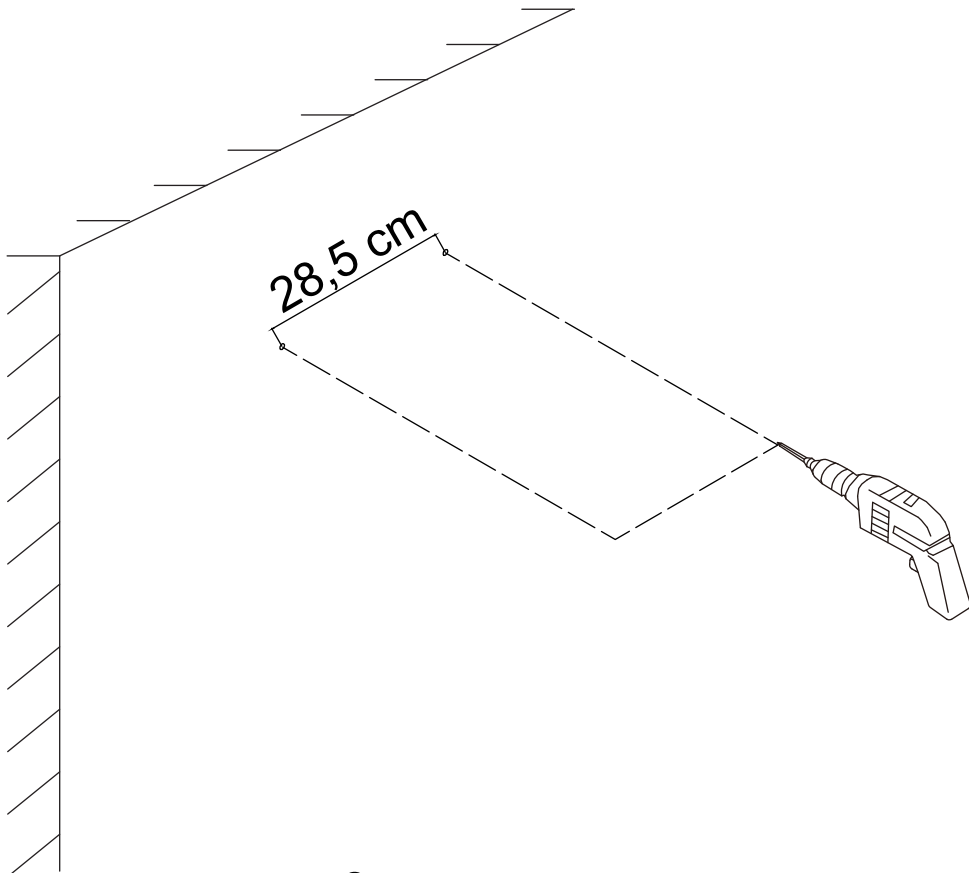

3

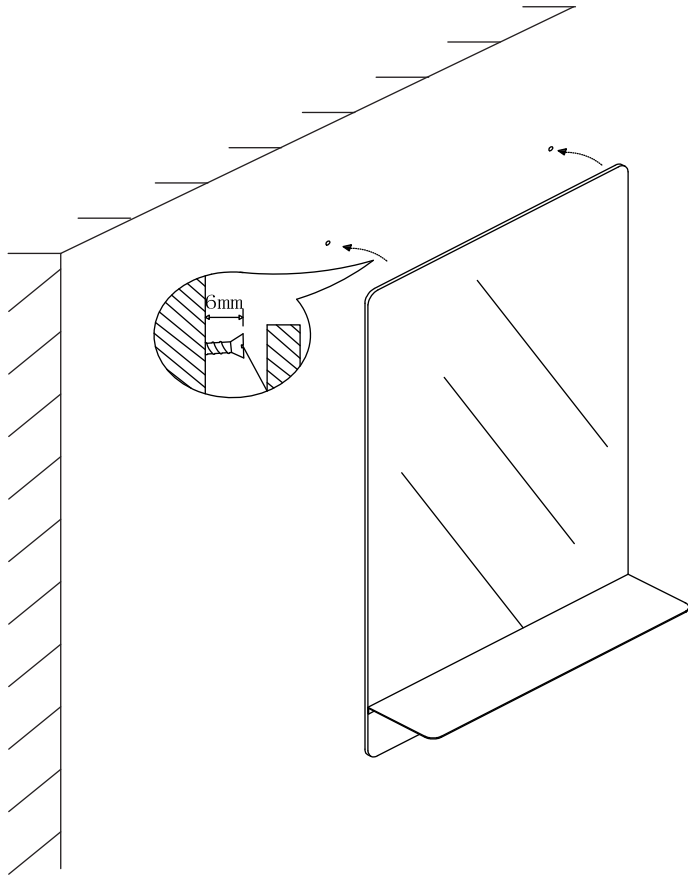

4

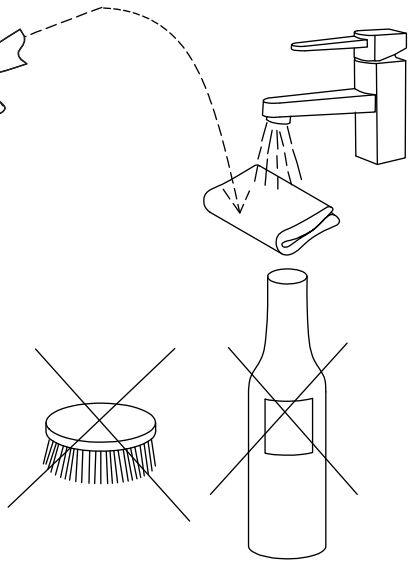
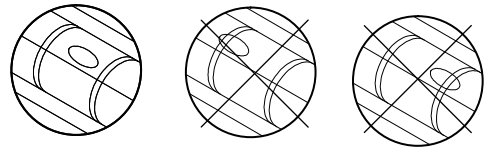
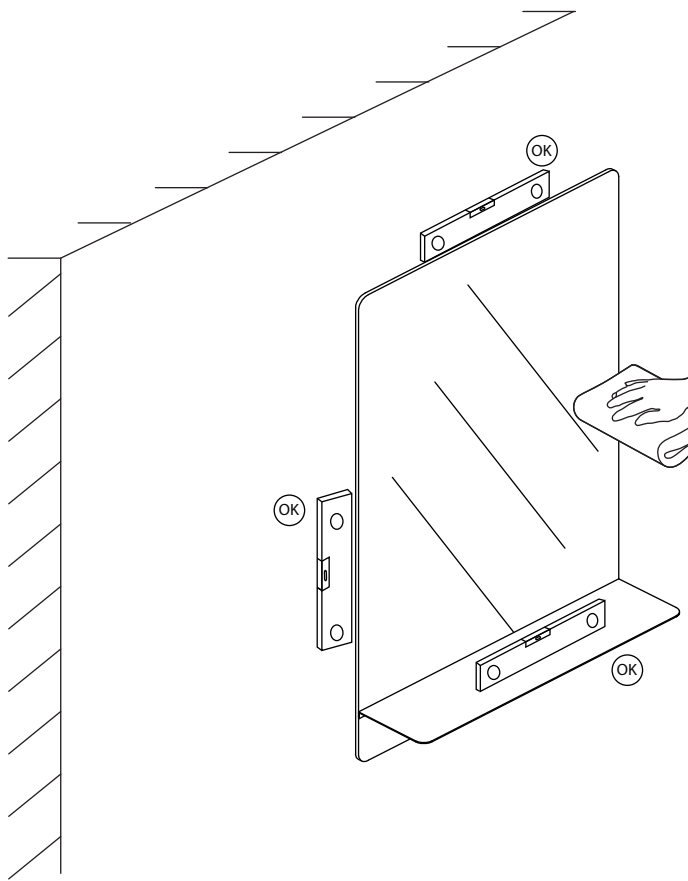

FR **Donnez ou recyclez vos meubles.** Association ou Magasin ou Déchèterie

FR  

<https://quefairedemesdechets.fr>