

COOKETM &LEWIS

PURE 80 cm / PURE 90 cm

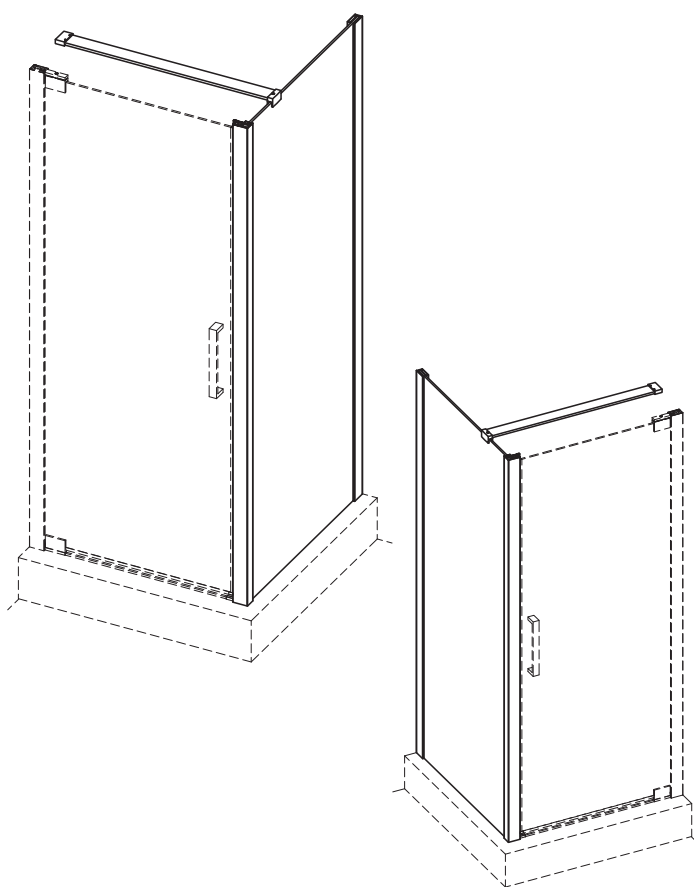

PURE - Version: 01

693861 / 693862

FR

PURE - Réf : 5052931591176 / 5052931591183



AVERTISSEMENT : Lisez ces instructions avant d'utiliser l'appareil.



[02] x 1



[27] x 1



[28] x 1

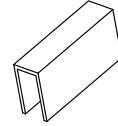

[29] x 1

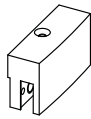

[30] x 1

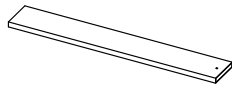

[32] x 1

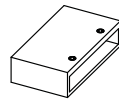

[33] x 1



[34] x 1

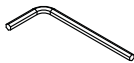

[35] x 1
(2.5mm)

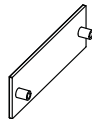

[36] x 1



[03] x 1
(ST3.9x35mm)



[31] x 1
(ST3.9x9.5mm)

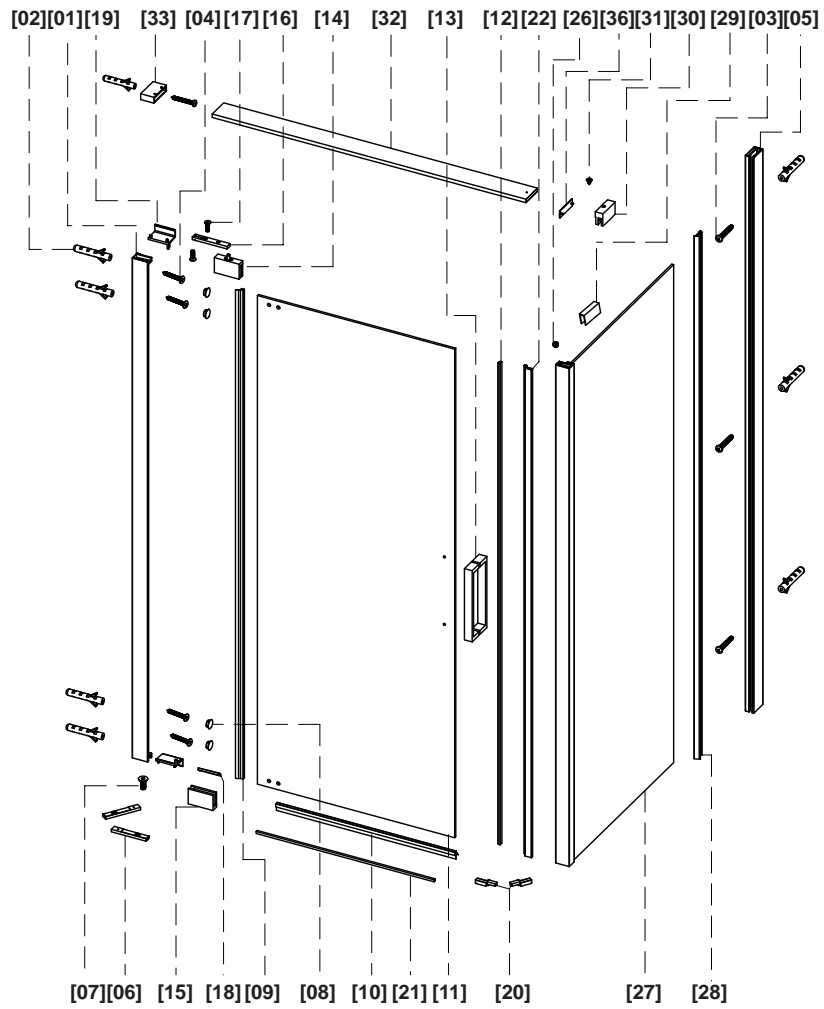

Cette paroi de douche est réversible. Vous devrez adapter les instructions données dans ce manuel, en fonction de votre choix.

C'est parti...

Ces instructions ont été rédigées pour votre sécurité. Veuillez les lire attentivement avant toute utilisation, puis conservez-les afin de pouvoir vous y référer ultérieurement.



Pour bien commencer...

05

Avant de commencer

05



Et dans le détail...

07

Sécurité

07

Entretien et maintenance

09

Informations techniques et légales

09



Installation

11

Points à vérifier avant de commencer

- Vérifiez le contenu du paquet et assurez-vous que tous les composants répertoriés sont présents.
- Lorsque vous êtes prêt pour commencer, veillez à disposer des bons outils à portée de main, de suffisamment d'espace et d'un endroit sec pour le montage.
- Assurez-vous que la surface de montage est solide, propre et sèche avant l'installation de la cabine.
- Assurez-vous que la cabine est fixée à un bac ou sol nivelé et à des murs verticaux,
- Remarque** : les chevilles murales fournies avec ce produit conviennent pour les murs solides uniquement. Les autres types de murs peuvent éventuellement nécessiter des fixations ou chevilles murales spéciales (non fournies). Assurez-vous toujours que les chevilles murales ou fixations sont adaptées au type de mur. En cas de doute, obtenez des conseils professionnels.
- Remarque importante : Bien que ces instructions soient complètes, il est toujours recommandé que l'installation soit réalisée par un installateur professionnel.
- Lors de travaux effectués à proximité d'un bac ou d'une baignoire, assurez-vous que les déchets sont couverts afin qu'aucun petit morceau n'y tombe.

Avant de commencer

Votre produit

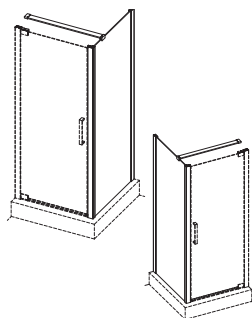

Pour installer votre produit, rendez-vous sur la séquence de montage située à la fin du guide

Vous aurez besoin de

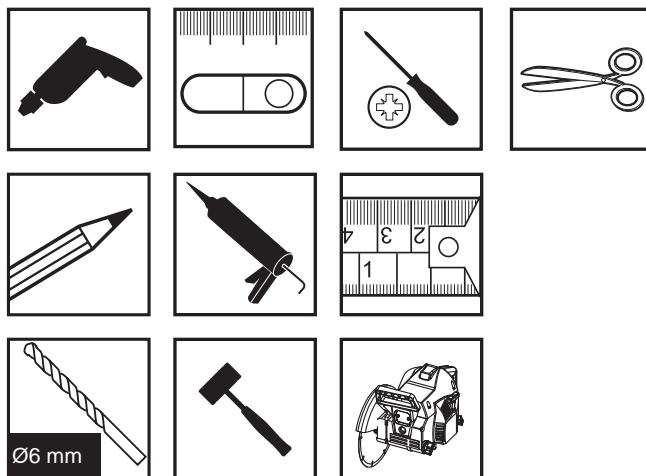

1 aide ponctuelle (pour certaines tâches)

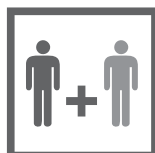



Vérifiez que vous avez intégré toutes les consignes ci-dessous:

- Des précautions doivent être prises lors des forages dans le mur pour éviter les tuyaux et les fils cachés.
- ATTENTION** : Fragile - manipulez le produit avec précaution. Ce produit peut causer des blessures, des dommages matériels ou se casser facilement s'il n'est pas manipulé, disposé et installé avec soin.
- ATTENTION** : Veuillez manipulez toute vitre avec précaution. Tout endommagement des bords ou rayure sur la surface susceptible de se produire en cours de montage ou d'utilisation normale peut provoquer la cassure soudaine de la vitre. La vitre trempée peut voler en petits éclats, dont les bords sont tout de même tranchants.
- Ne cognez pas la vitre avec des objets durs ou pointus.
- Ne tentez pas de découper la vitre.
- ATTENTION** : Assurez-vous toujours que le produit est correctement installé avant de l'utiliser.

Sécurité



Vérifiez que vous avez intégré toutes les consignes ci-dessous:

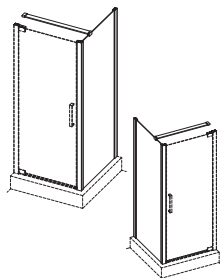

- Utilisation domestique uniquement.
- Lors de forages dans des carrelages en céramique, utilisez un foret spécial.
- Dans la mesure du possible, forez dans les joints de ciment entre les carrelages.
- ATTENTION** : NE serrez PAS les fixations excessivement. Cela pourrait endommager le produit .
- A monter soi même.



AVERTISSEMENT : Le non-respect de ces instructions peut entraîner des blessures et des dommages matériels, voire endommager le produit.

Les 3 règles d'or pour l'entretien et la maintenance

- 1 Utilisez de l'eau tiède savonneuse et un chiffon doux humide pour garder la vitre propre. Essuyez à l'aide d'un chiffon propre. Si nécessaire, vous pouvez utiliser un produit pour vitres. Grattoirs, abrasifs et nettoyeurs chimiques peuvent endommager la vitre et le motif, et ne doivent ainsi pas être utilisés.
Vérifiez régulièrement les pièces mobiles telles que les rouleaux et charnières afin de vous assurer qu'elles sont solidement fixées et correctement réglées. Serrez et ajustez-les lorsque nécessaire. Vérifiez également tous les joints scellés afin de vous assurer de l'intégrité de l'étanchéité. Scellez à nouveau au besoin.
- 2 Dans les régions dont l'eau est dure, un dépôt de calcaire peut se former sur la vitre. Si vous le laissez s'accumuler, il deviendra de plus en plus difficile à enlever, et sera inesthétique. Un nettoyage régulier permet de réduire cet effet.

Informations techniques et légales

	Merci de consulter le site www.castorama.fr pour accéder à la déclaration de performance du produit N°DOP : CASTO-693861-KIN-15
Importé Par CASTORAMA France C.S.50101 Templemars 59637 Wattignies CEDEX 15 Déclaration de performance CASTO-693861-KIN-15 Side Panel PURE 80 - Code 693861	
EN14428 :2004 + A1 :2008 Utilisation prévue: l'hygiène personnelle	
Produit type : Side Panel PURE 80 1142203-80SIDE	
Aptitude au nettoyage :	conforme
Résistance à l'impact / Comportement à l'éclatement :	conforme
Durabilité :	conforme

Informations techniques et légales

	<p>Merci de consulter le site www.castorama.fr pour accéder à la déclaration de performance du produit N°DOP : CASTO-693862-KIN-15</p>
<p>Importé Par CASTORAMA France C.S.50101 Templemars 59637 Wattignies CEDEX 15 Déclaration de performance CASTO-693862-KIN-15 Side Panel PURE 90 - Code 693862</p>	
<p>EN14428 :2004 + A1 :2008 Utilisation prévue: l'hygiène personnelle</p> <p>Produit type : Side Panel PURE 90 1142203-90SIDE</p> <p>Aptitude au nettoyage : conforme Résistance à l'impact / Comportement à l'éclatement : conforme Durabilité : conforme</p>	



**IMPORTANT - A CONSERVER POUR
CONSULTATION ULTERIEURE : A LIRE
SOIGNEUSEMENT**

Installation

01



[02] x 4



[04] x 4



[06] x 1



[07] x 1



[08] x 4



[24] x 1

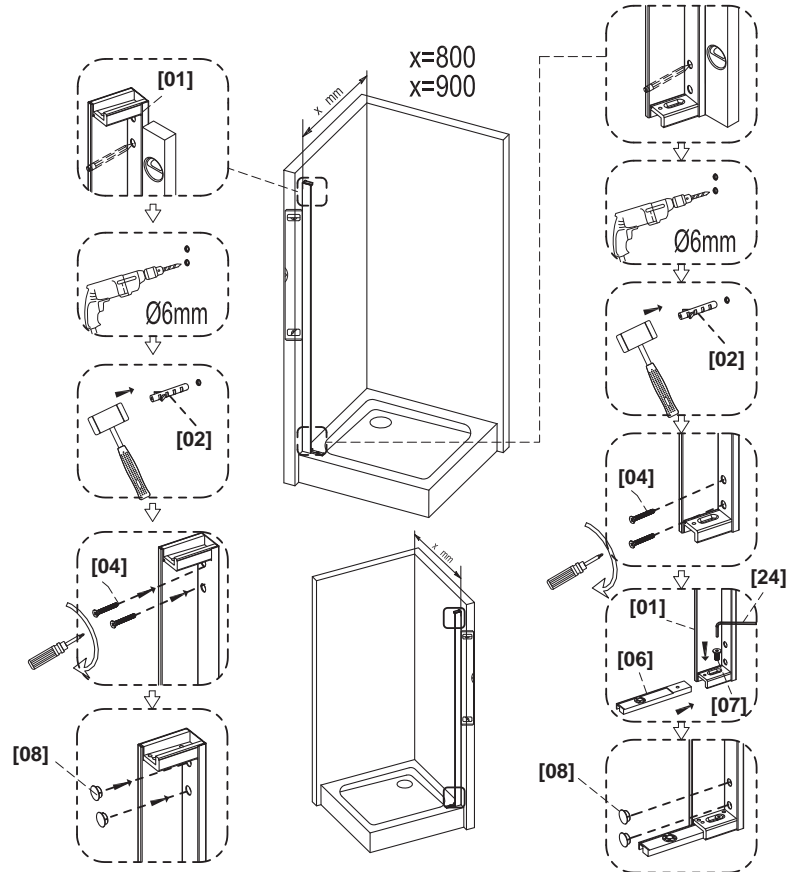



02

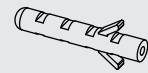
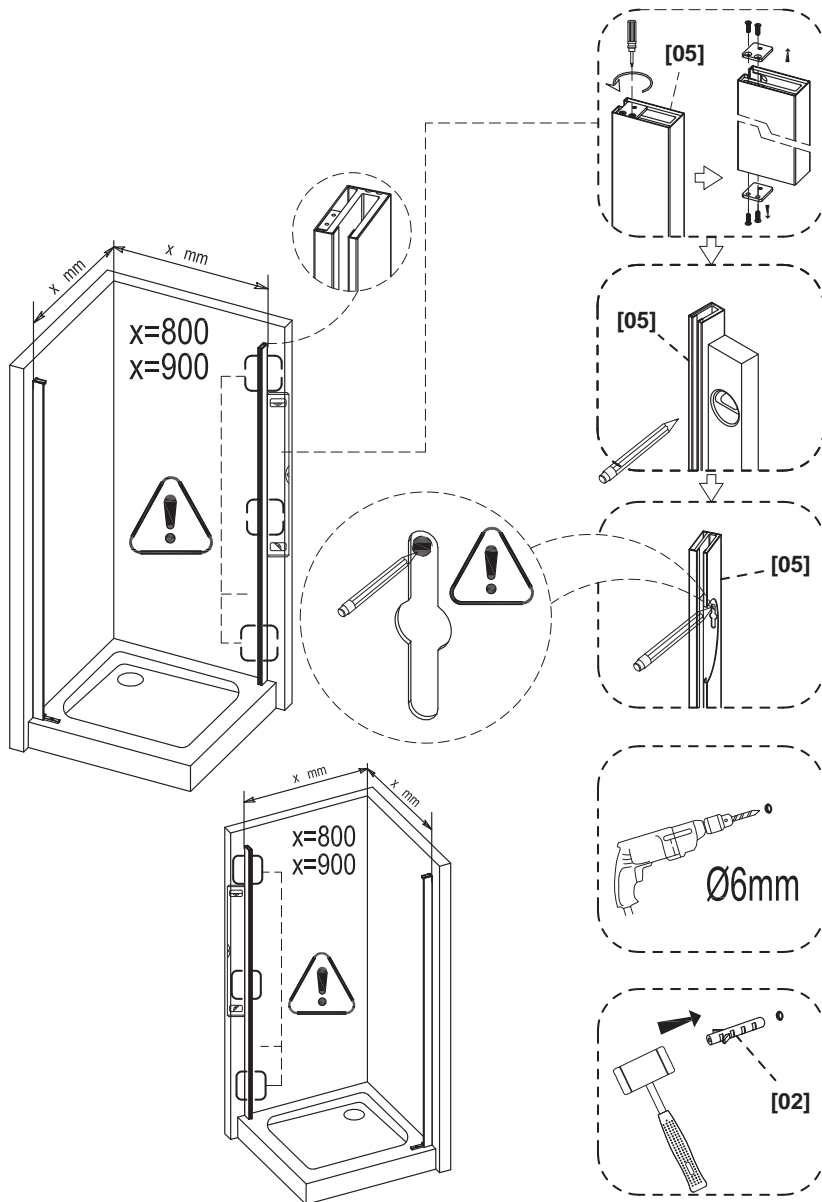

[02] x 3



[05] x 1

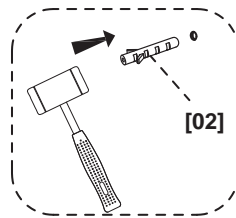
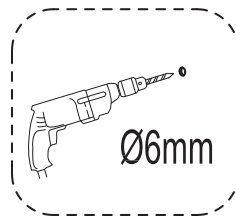
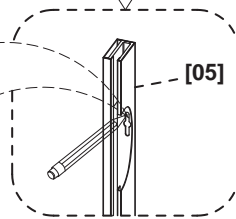
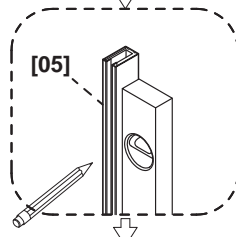
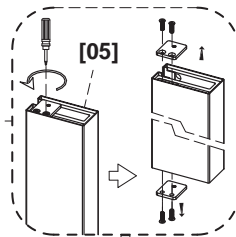

03



[03] x 3

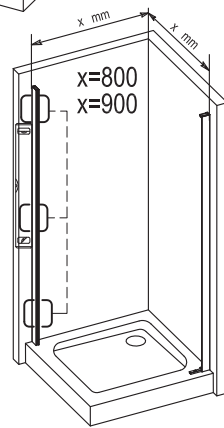
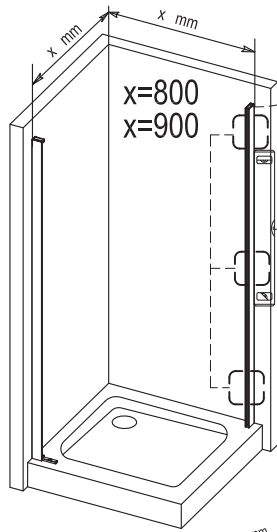
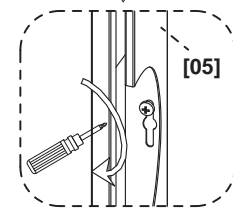
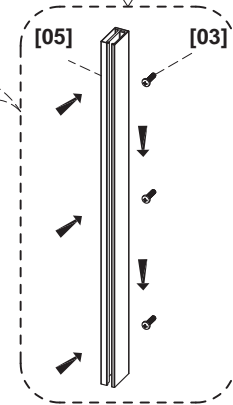
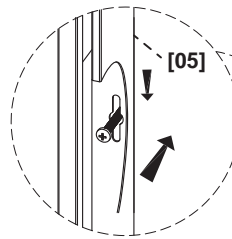
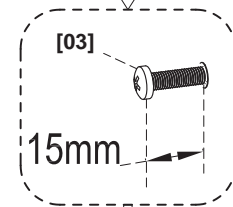
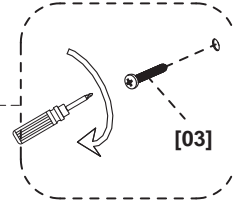
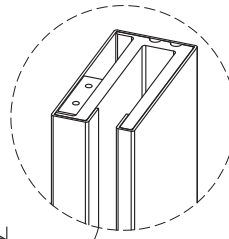



04

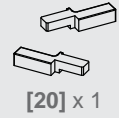

[21] x 1



[27] x 1

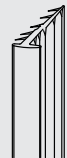

[28] x 1



[34] x 1

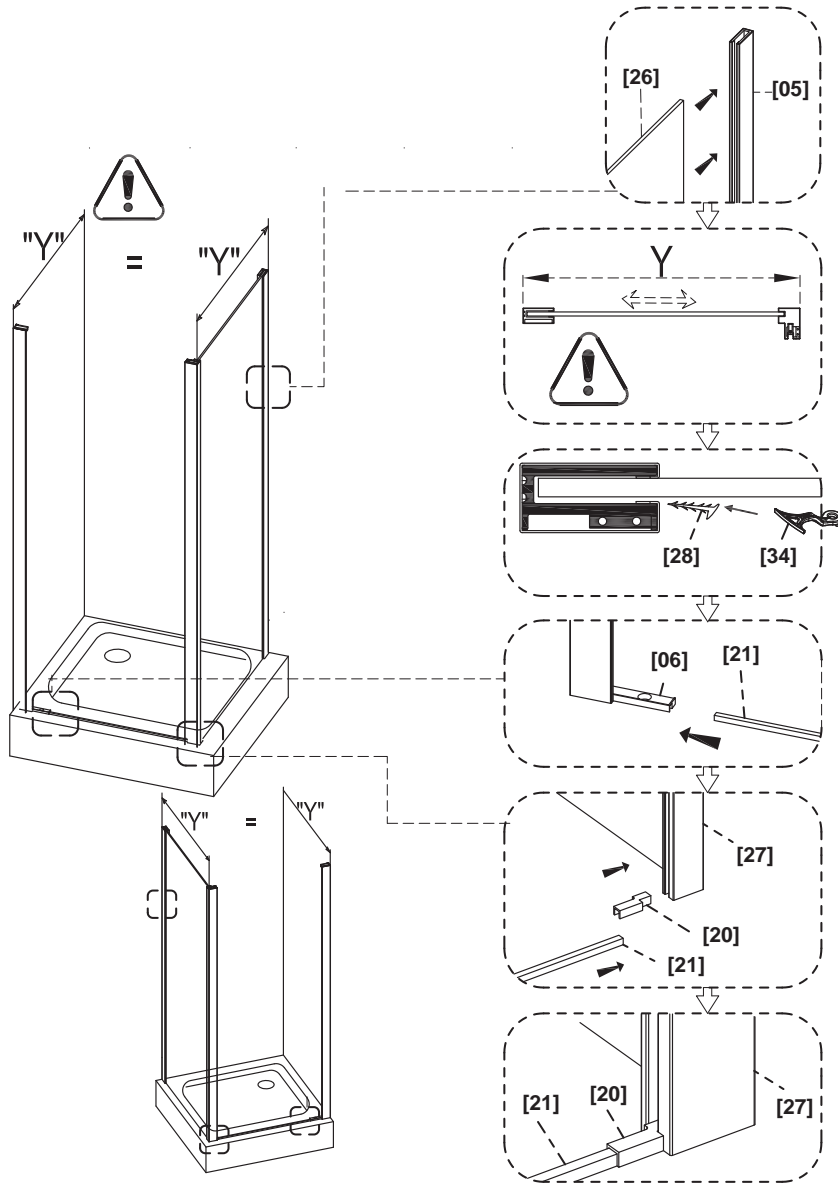

05



[26] x 1

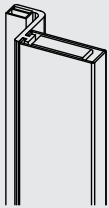

[22] x 1



[23] x 1

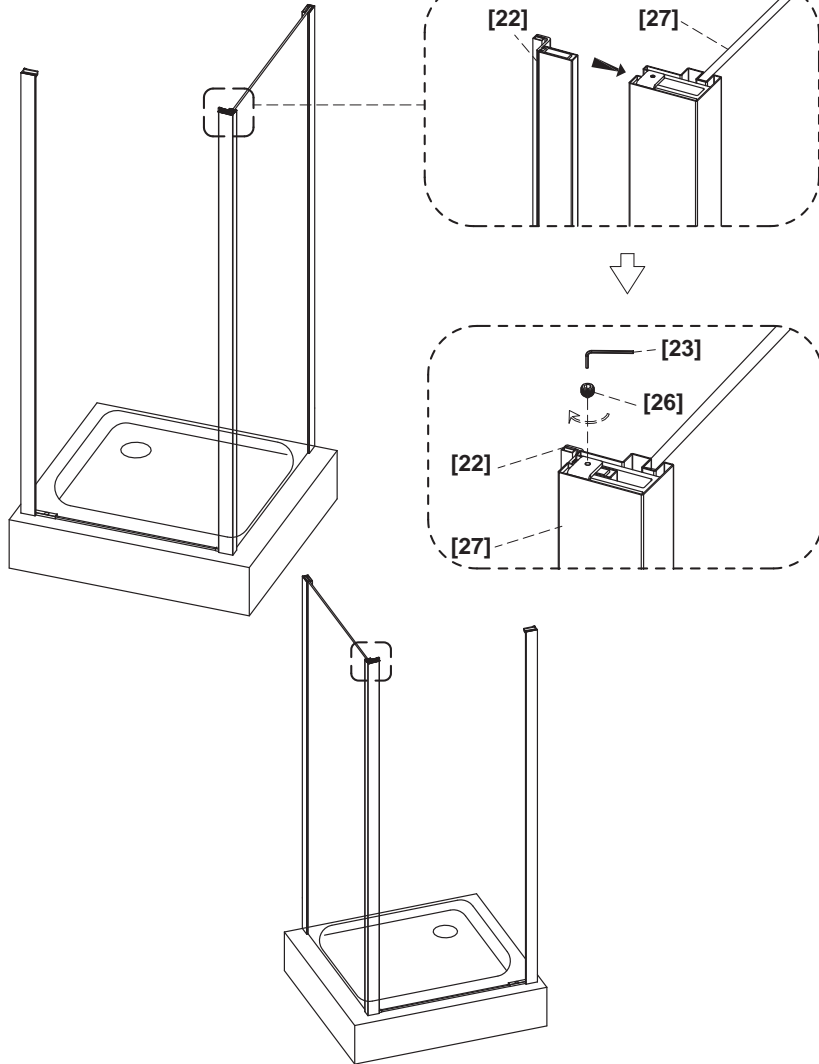



06

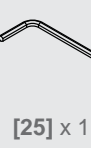
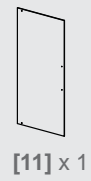
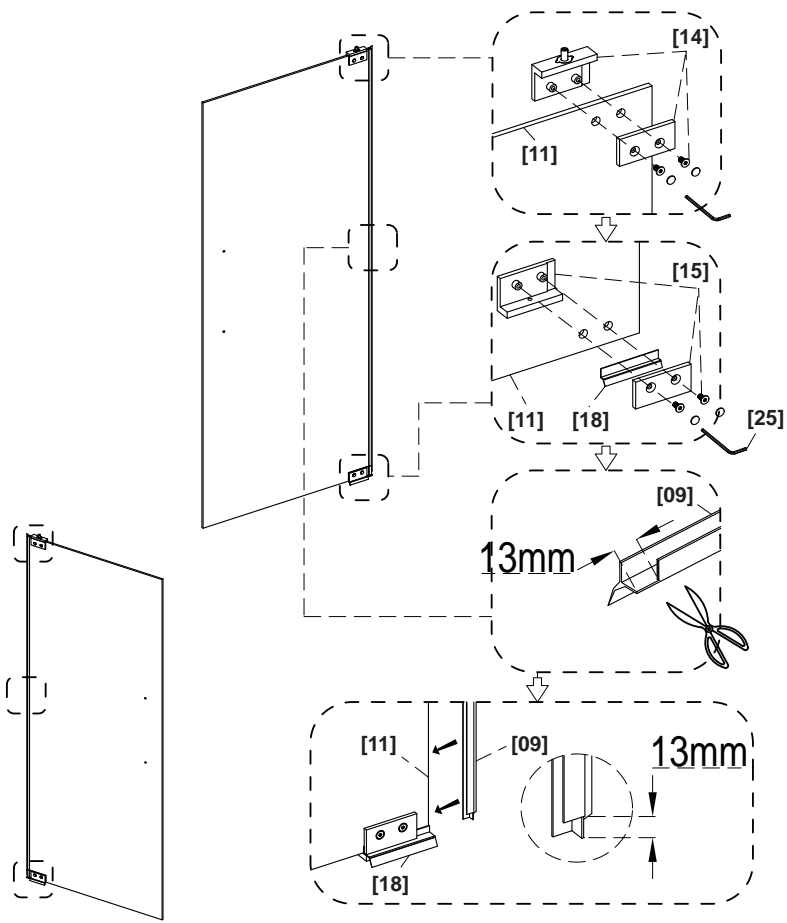

07



[10] x 1



[12] x 1



[13] x 1

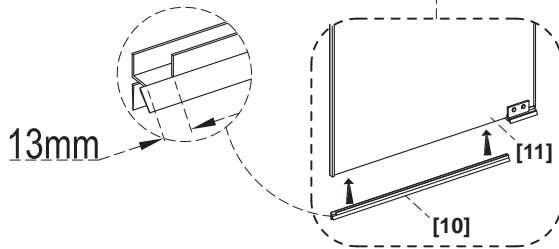
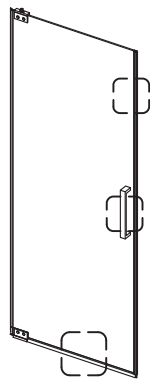
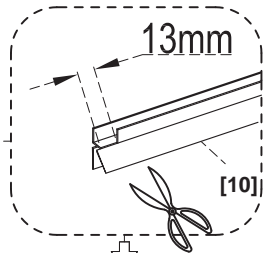
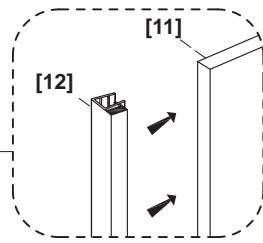
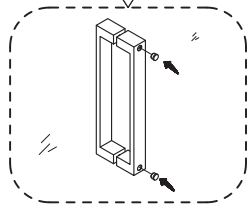
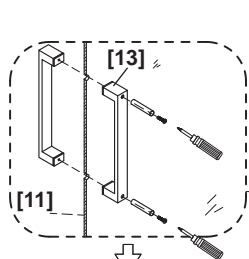



08

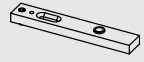

[16] x 1



[17] x 2



[23] x 1

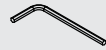

[24] x 1

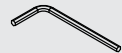

[25] x 1

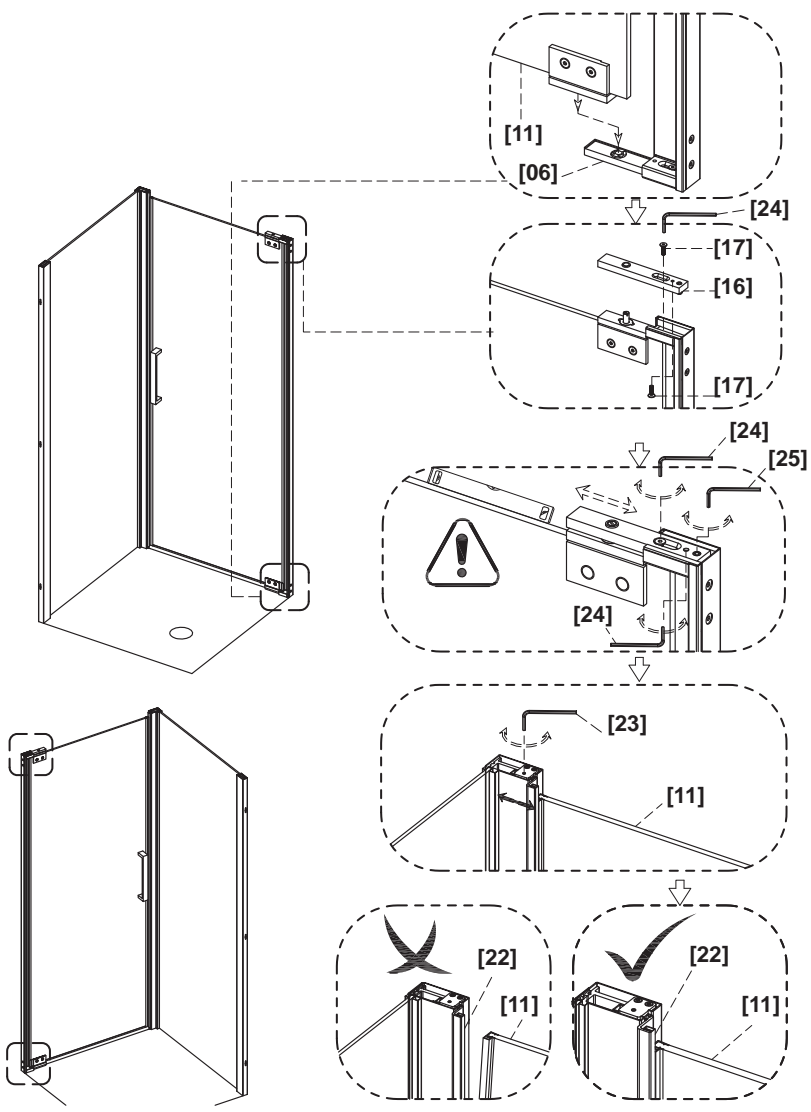

09

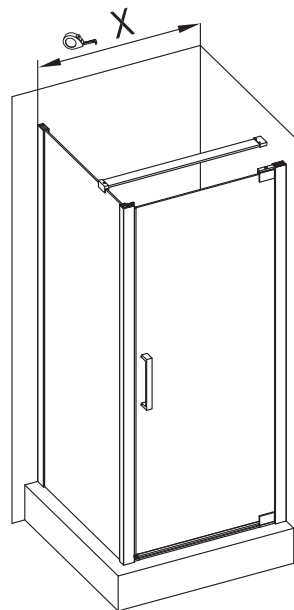
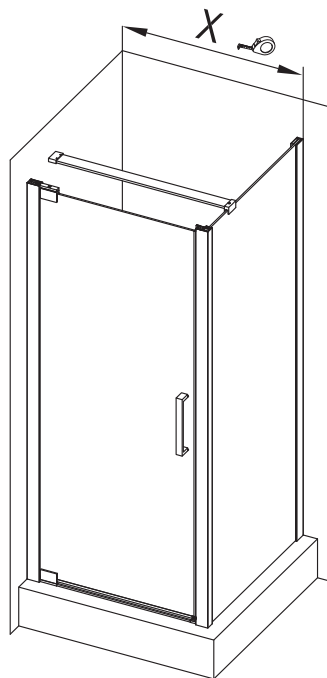
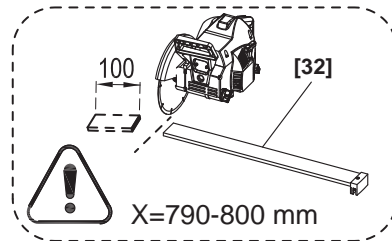
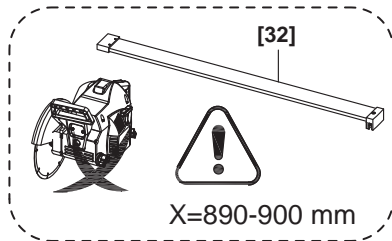



10

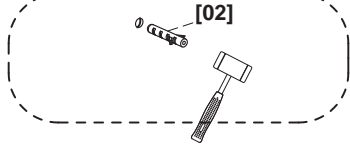
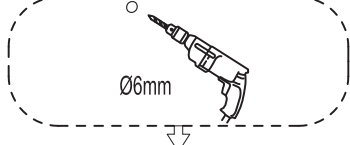
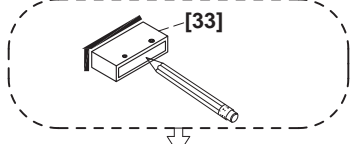
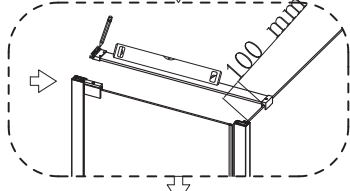
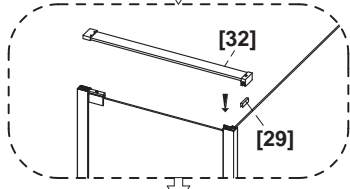
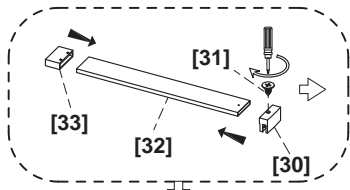
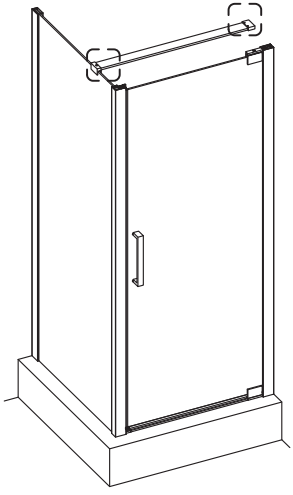
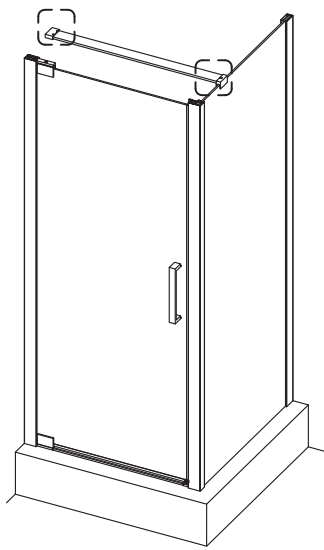

[02] x 1

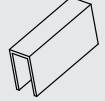

[29] x 1

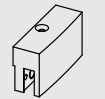

[30] x 1



[31] x 1

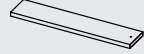

[32] x 1

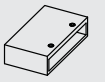

[33] x 1



[36] x 1

11

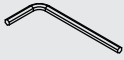

[35] x 1

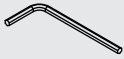

[25] x 1

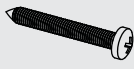

[03] x 1

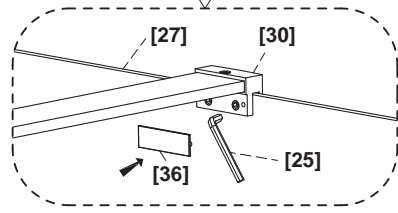
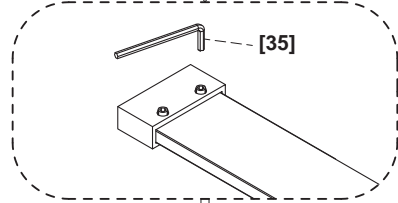
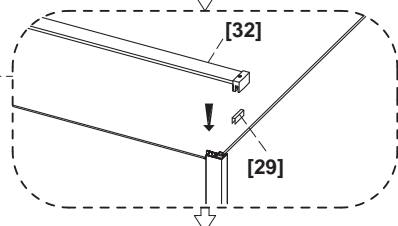
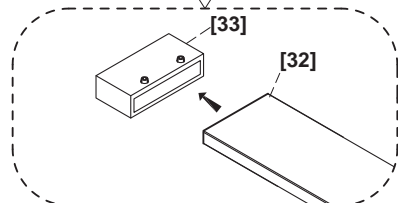
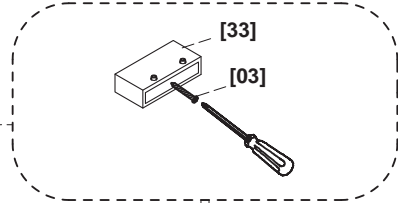
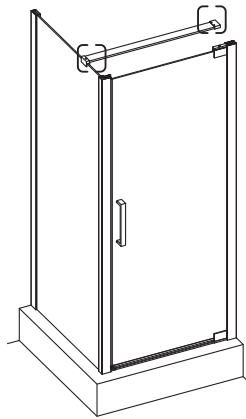
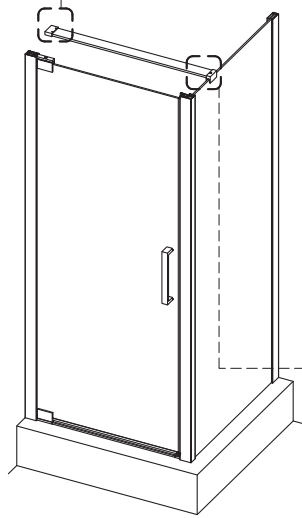



12

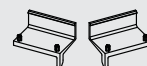

[19] x 1

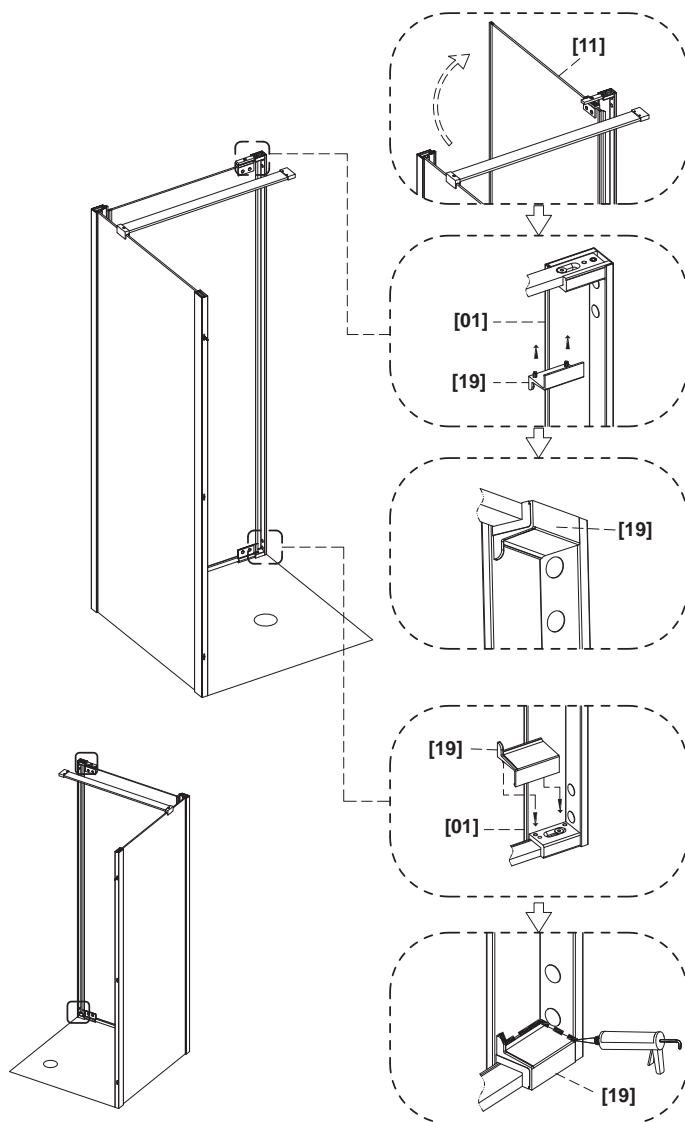

13

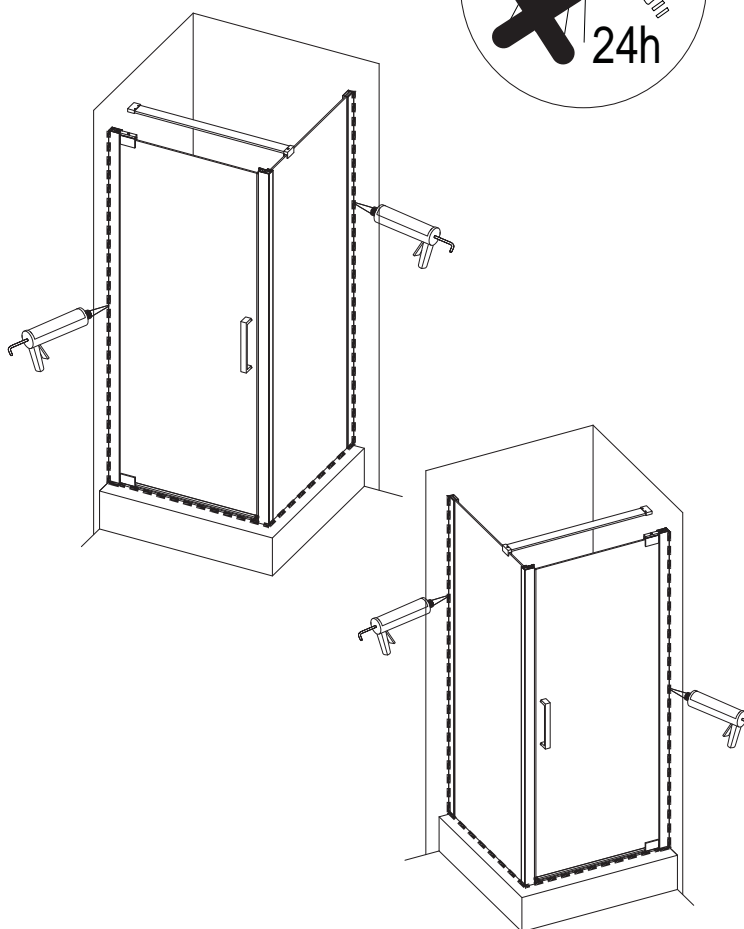

Veuillez attendre 24 heures avant d'utiliser votre cabine de douche afin de permettre au silicone de sécher entièrement.



Castorama France

C.S. 50101 Templemars.
59637 Wattignies CEDEX
www.castorama.fr

 **N°Azur 0 810 104 104**

Dites «Question» (prix appel local)

Fabriqué en RPC

