

DUNE

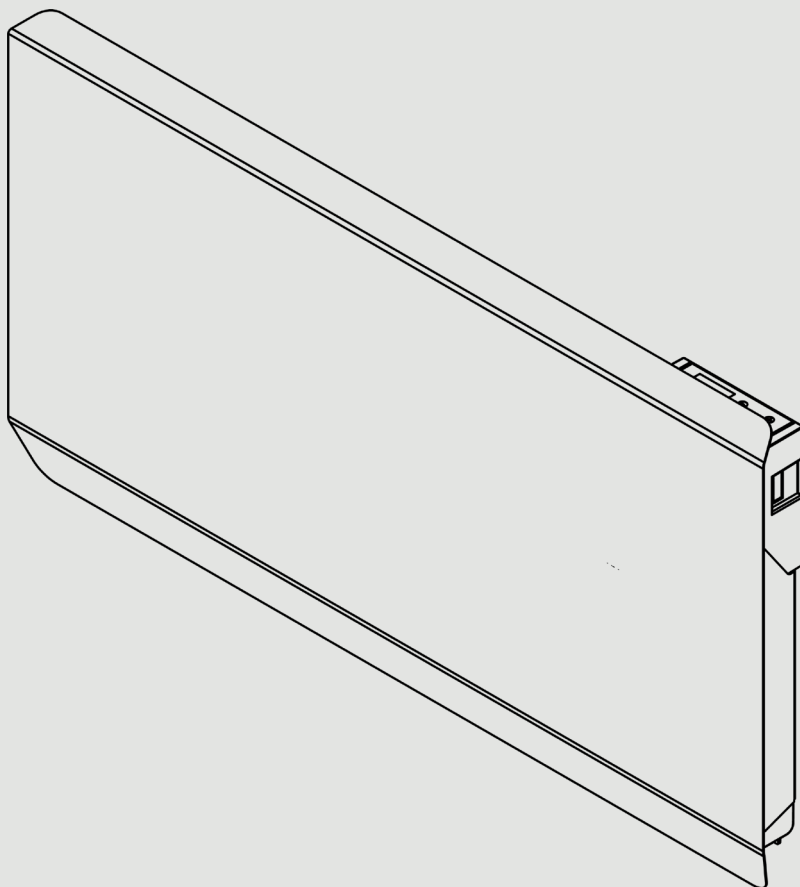

DELTACALOR



NOTICE D'UTILISATION ET D'INSTALLATION
OPERATION AND INSTALLATION MANUAL
MANUALE D'USO E INSTALLAZIONE
MANUAL DE USUARIO Y DE INSTALACIÓN

DOC.IS.006016

M

20/05/22

[FR]-[3]

Seul un usage approprié des instructions suivantes pourra garantir la sécurité du produit. Il est donc fortement conseillé de les lire avant l'installation et de les conserver pour un éventuel usage futur. Dans le cas où des doutes relatifs au montage du produit surviendraient, il est conseillé de demander l'intervention d'une personne technique qualifiée.

[EN]-[35]

These instructions must be read carefully to ensure the product operates safely. We would therefore strongly recommend reading them before starting on installation and keep them for future reference. Call a qualified technician for help if you have any doubts about installing the product.

[IT]-[67]

Queste istruzioni devono essere lette attentamente per garantire il funzionamento in sicurezza del prodotto. Pertanto si raccomanda fortemente di leggerle prima di procedere con l'installazione e di conservarle per poterle consultare in futuro. In caso di dubbi circa le modalità di installazione del prodotto, chiedere assistenza a un tecnico qualificato.

[ES]-[99]

Se deben seguir correctamente todas las instrucciones para mantener la seguridad del producto. Por lo tanto, se recomienda particularmente leerlas antes de instalar el aparato y mantenerlas para referencia futura. Si no está seguro de la instalación del producto, solicite la ayuda de un técnico cualificado.



CONSIGNES DE SÉCURITÉ



- Tout dommage résultant du non-respect de ces consignes entraîne la non application de la garantie constructeur.
- Ne pas utiliser l'appareil à l'extérieur.
- Votre appareil est destiné à un usage domestique et ne doit pas être utilisé à d'autres fins.
- Si l'appareil est tombé, endommagé ou ne fonctionne pas correctement, ne pas mettre l'appareil en marche et s'assurer que l'alimentation de l'appareil est coupée (fusible ou disjoncteur).
- Ne jamais démonter l'appareil. Un appareil mal réparé peut présenter des risques pour l'utilisateur.
- Pour tout problème, consultez votre point de vente.
- Si le câble d'alimentation est endommagé, il doit être remplacé par le fabricant, son service après-vente ou un autre professionnel, afin d'éviter tout danger. Attention: le câble d'alimentation ne doit pas toucher le corps chauffant.
- Avertissement: Afin d'éviter une surchauffe, ne pas couvrir l'appareil. Si l'appareil est couvert, l'élévation de la température déclenchera le limiteur interne.
- L'appareil de chauffage ne doit pas être placé juste en dessous d'une prise de courant.
- L'appareil de chauffage doit être installé de façon telle que les interrupteurs et autres dispositifs de commande ne puissent être touchés par une personne qui se trouve dans la baignoire ou sous la douche (réf. norme NF C15-100).
- Le circuit d'alimentation de cet appareil doit comporter un dispositif de coupure omnipolaire (réf. norme NF C15-100).



Ne pas couvrir l'appareil de chauffage.



AVERTISSEMENT POUR LES PERSONNES HANDICAPÉES ET LES ENFANTS



- Cet appareil peut être utilisé par des enfants âgés de plus de 8 ans et par des personnes ayant des capacités physiques, sensorielles ou mentales réduites ou dénuées d'expérience ou de connaissance, s'ils (si elles) sont correctement surveillé(e)s ou si des instructions relatives à l'utilisation de l'appareil en toute sécurité leur ont été données et si les risques encourus ont été appréhendés.
- Les enfants ne doivent pas jouer avec l'appareil.
- Le nettoyage et l'entretien par l'utilisateur ne doivent pas être effectués par des enfants sans surveillance.
- Il convient de maintenir à distance les enfants de moins de 3 ans, à moins qu'ils ne soient sous une surveillance continue.
- Les enfants âgés entre 3 ans et 8 ans doivent uniquement mettre l'appareil en marche ou à l'arrêt, à condition que ce dernier ait été placé ou installé dans une position normale prévue et que ces enfants disposent d'une surveillance ou aient reçu des instructions quant à l'utilisation de l'appareil en toute sécurité et en comprennent bien les dangers potentiels.
- Les enfants âgés entre 3 ans et 8 ans ne doivent ni brancher, ni régler ni nettoyer l'appareil, et ni réaliser l'entretien de l'utilisateur.

ATTENTION

Certaines parties de ce produit peuvent devenir très chaudes et provoquer des brûlures. Il faut prêter une attention particulière en présence d'enfants et de personnes vulnérables.



PRESCRIPTION D'AVERTISSEMENT



L'appareil permet le contrôle à distance à travers la communication wi-fi.



Il est obligatoire de respecter une distance d'au moins 20 cm de la zone de présence humaine habituelle.





SÉCURITÉ ENFANTS

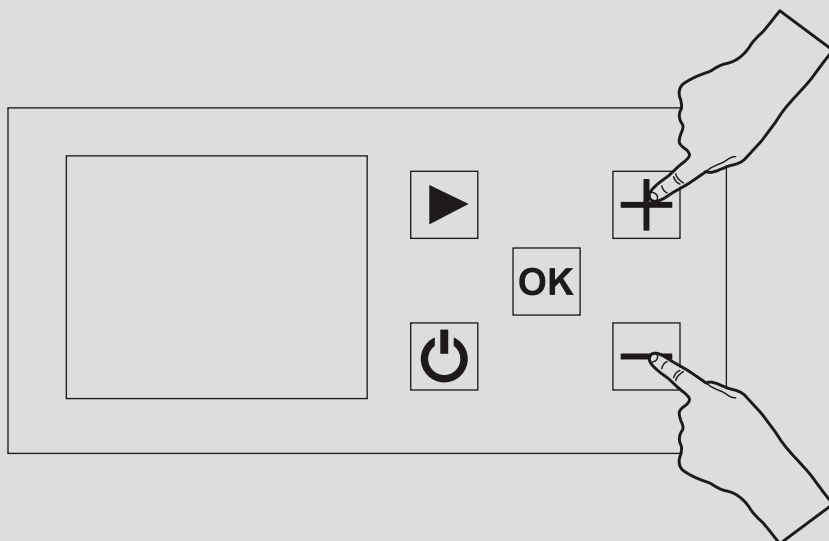

Verrouillage clavier «»

Pour activer/désactiver la fonction de verrouillage du clavier appuyez sur les touches  et  pendant 5s.



Toutes les touches sont verrouillées sauf celle de Marche / Arrêt chauffage .

Dans ce mode il est impossible de modifier la configuration des programmes, la température ou d'activer les autres fonctions.

ALIMENTATION ET RACCORDEMENT ÉLECTRIQUES

- L'alimentation de l'appareil de chauffage doit être protégée, conformément aux normes en vigueur, par un interrupteur différentiel

de 30 mA et un dispositif de protection contre les surintensités adapté aux caractéristiques de la ligne de raccordement.

- Avant la première utilisation, vérifier que la tension utilisée correspond

bien à celle indiquée sur l'appareil.

- Ce appareil de chauffage est un appareil de classe II (double isolation électrique).

- Le raccordement à la terre est interdit.

- Le raccordement des trois fils doit être réalisé dans une boîte de raccordement électrique conforme aux normes en vigueur.

- Conformément aux normes françaises, vous ne devez pas adapter à ce cordon une fiche pour le branchement dans une prise.

- Vous devez isoler le fil pilote si celui-ci n'est pas utilisé.

Alimentation monophasée 230 V~ ±10% 50 Hz.

- Fil bleu/gris : Neutre

- Fil Marron : Phase

- Fil noir : Fil pilote

FIXATIONS DES SUPPORTS MURAUX

1. Avant le montage du radiateur au mur, vérifiez que les distances indiquées sur les dessins «PRÉPARATION D'INSTALLATION» soient respectées (voir p.6).
2. Déterminez dans le tableau votre modèle de radiateur et respecter les hauteurs et la largeur indiquées pour le montage des pattes de fixation. Pour aide à l'installation, faire référence aux dessins 1 et 2 (voir page suivante).

| Puissances | H | L |
|------------|--------|--------|
| 1000 W | 207 mm | 220 mm |
| 1500 W | 207 mm | 420 mm |
| 2000 W | 207 mm | 620 mm |

H = Hauteur trous de fixation
L = Largeur trous de fixation

3. Fixez les supports au mur en utilisant des chevilles (non fournies) adaptées à la structure du mur sur lequel le radiateur est positionné.
4. Une fois fixé, fermez le système de sécurité avec les vis comme indiqué sur le dessin 3 (voir page suivante).

REMARQUE

Les vis et les chevilles ne sont pas fournies.



4 x V

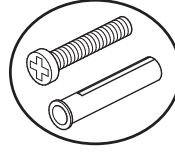

Utilisez le gabarit fourni dans la boîte

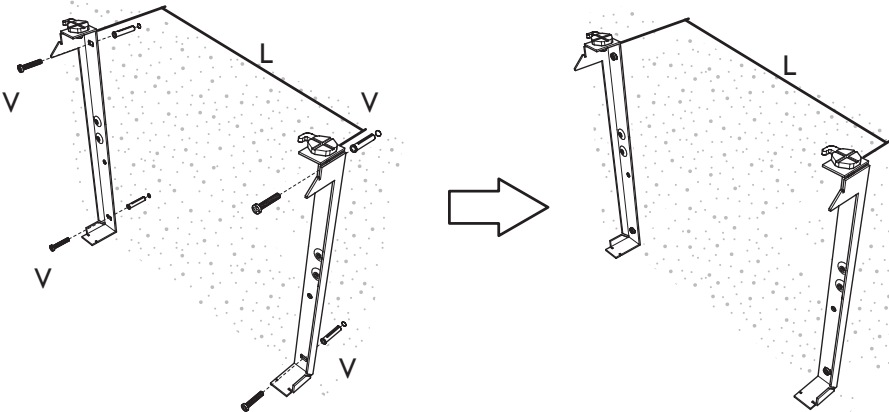
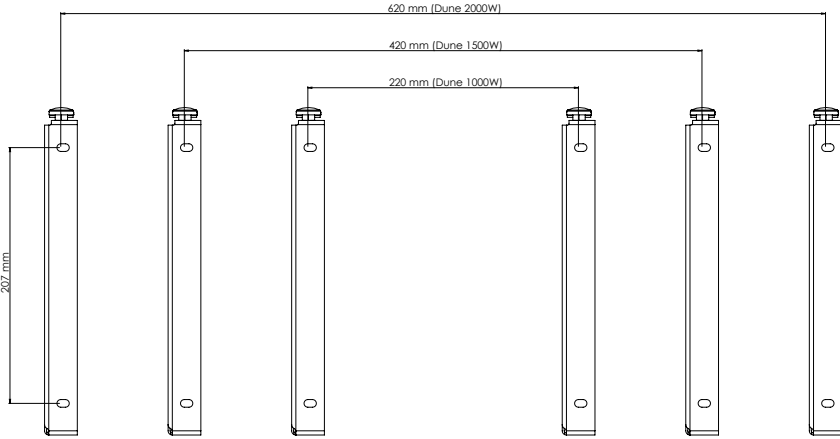

3

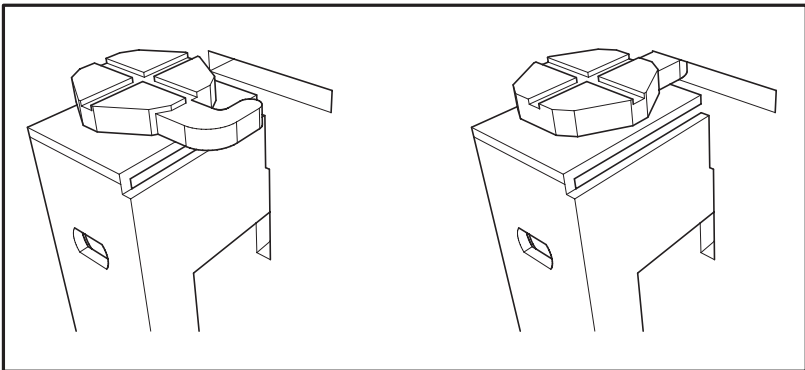
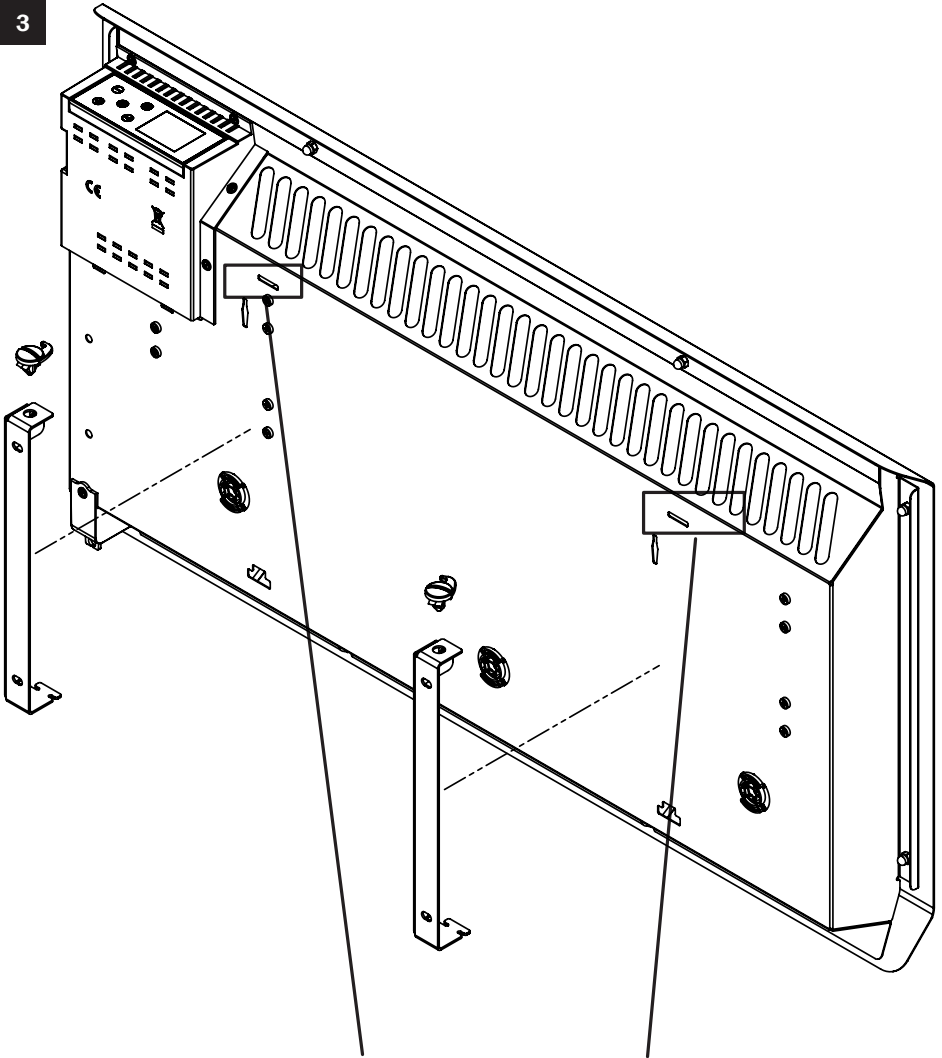

UTILISATION CORRECTE

Utilisez le produit de la façon indiquée sur la figure 1. Ne posez en aucun cas de serviettes ni de vêtements sur le cadre extérieur (figure 2). Une utilisation incorrecte risque de causer de dangereuses surchauffes et de compromettre le fonctionnement de l'appareil.

Pour nettoyer l'appareil, n'utilisez aucun produit chimique, mais servez-vous d'un chiffon humide non abrasif.

1

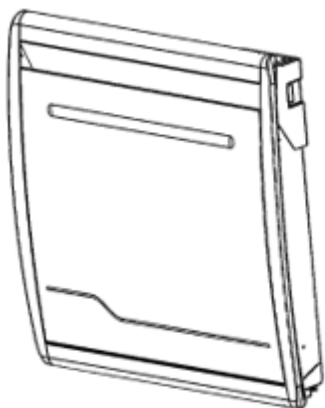

2

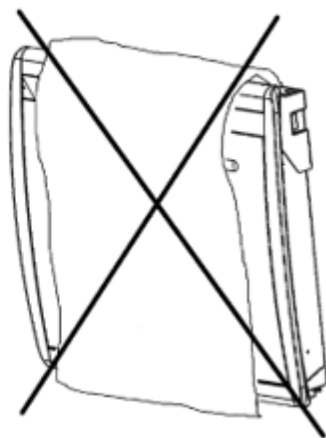

CARACTERISTIQUES DE L'INTERFACE UTILISATEUR

Afficheur

L'afficheur est muni de rétroéclairage.

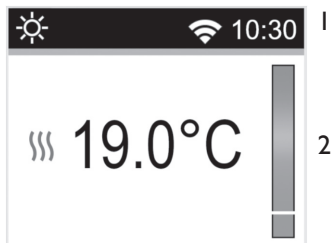

1 - Informations sur le mode de fonctionnement/menu du thermostat, heure et connexion WiFi.

2 - Informations sur:

- Mode de fonctionnement du thermostat: température de consigne, indicateur comportemental, température mesurée, témoin de chauffe du radiateur.
- Configuration des paramètres: affichage de la valeur réelle des paramètres.
- Sélection du programme pour le mode AUTO.

Le clavier comprend 5 touches:

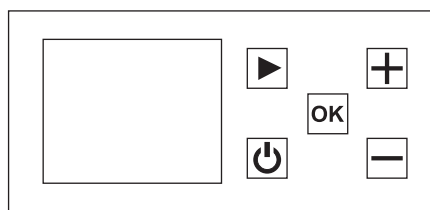

| | |
|--|--|
| | Touche ON/OFF (Marche / Arrêt chauffage) |
| | Touche moins |
| | Touche de validation |
| | Touche plus |
| | Touche de navigation droite |

PREMIER ALLUMAGE ET INSTALLATION

Lorsque le thermostat est allumé ou après la réinitialisation/remise à zéro du produit, cette première page-écran s'affiche.

Le numéro correspond à la version du logiciel du produit.

La deuxième page-écran dépend de l'état du thermostat:

- Lors du premier démarrage du produit, l'utilisateur sera en mesure de configurer directement sa connexion WIFI, la date et l'heure du jour.

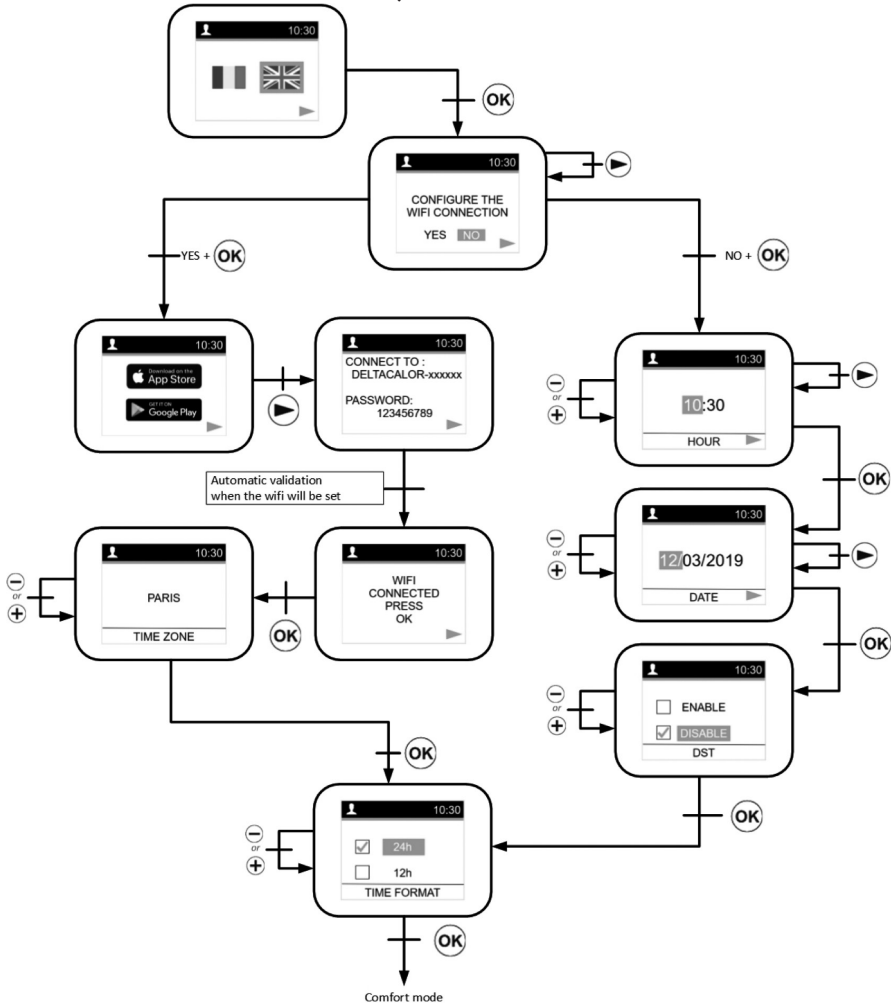

- Pour configurer un radiateur et l'associer à votre réseau WIFI avec l'application « DELTACALOR CONFORT » allez à page 30.

Après une coupure de courant, ce sera la page-écran du mode en cours.

Après une remise à zéro du produit ou une coupure de courant très longue, la page-écran du temps de modification s'affichera.

MENU DE SELECTION DU MODE

Pour modifier le mode en cours du thermostat, l'utilisateur doit appuyer sur la touche ► de navigation droite pour accéder à la sélection du menu.

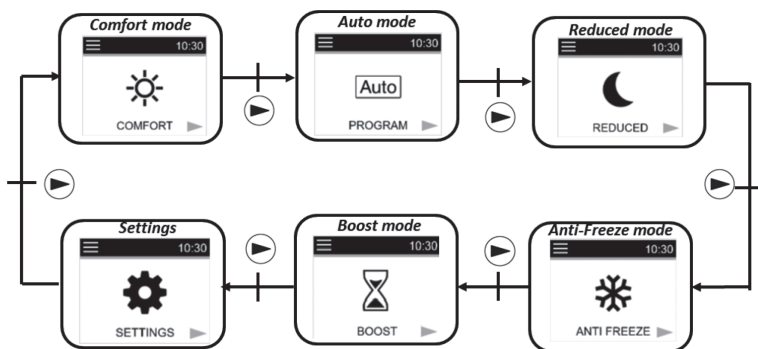

L'utilisateur déplace le curseur du cadre pour choisir un mode de travail.

Pour sélectionner un mode, il faut appuyer sur **OK**.

Validez le mode choisi en appuyant sur la touche **OK** sinon le thermostat revient automatiquement au dernier mode sélectionné **☒**, **☒**, **☒**, ou **Auto**.

En la touchant **⏸**, les utilisateurs accèdent directement au mode Marche / Arrêt chauffage:



Lorsqu'il n'y a aucune activité sur le clavier pendant 5 à 10 secondes, un économiseur d'écran s'affiche.

Cet économiseur d'écran pourrait être la valeur de la température mesurée ou nulle:



Définition des modes de fonctionnement

Mode Confort

Dans ce mode, température de confort le point de consigne sera suivi tout le temps. Sur l'économiseur d'écran (rétroéclairage activé), si vous appuyez sur la touche **-** ou sur les touches **+**, la température de configuration confort commence à clignoter et vous pouvez la modifier. Si vous appuyez sur la touche **OK** ou en attendant 15 seconds sans faire aucune action, la valeur du point de consigne est validée. Ce point de consigne sera utilisé en mode **Auto** pendant la phase haute du programme sélectionné . A partir de l'économiseur d'écran (rétroéclairage activé) si vous appuyez sur **OK** vous pouvez faire passer l'affichage de la température mesurée à la température de configuration.

Si vous appuyez sur la touche **▶**, vous affichez le menu de navigation.

Si vous appuyez sur la touche **⏻**, le thermostat est désactivé.

Valeur prédéfinie: 19°C.

Intervalle: de 10°C à 30°C. (la valeur maximum peut être modifiée dans le menu paramètres).

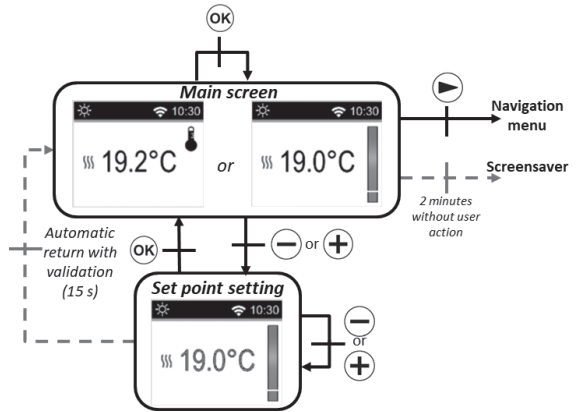

Mode Eco

Dans ce mode, le produit fonctionne à une température configurée réduite.

Sur l'économiseur d'écran (rétroéclairage activé), si vous appuyez sur la touche **-** ou **+**, la température de configuration réduite commence à clignoter et vous pouvez la modifier.

Si vous appuyez sur la touche **OK** ou en attendant 15 seconds sans faire aucune action, la valeur du point de consigne est activée.

Ce point de consigne sera utilisé en mode **Auto** pendant la phase haute du programme sélectionné .

Sur l'économiseur d'écran (rétroéclairage activé), la touche **OK** vous permet de faire passer l'affichage de la température mesurée à la température configurée.

Si vous appuyez sur la touche **▶**, vous affichez le menu de navigation



Si vous appuyez sur la touche **⏻**, le thermostat est désactivé.

Valeur prédéfinie: 17°C.

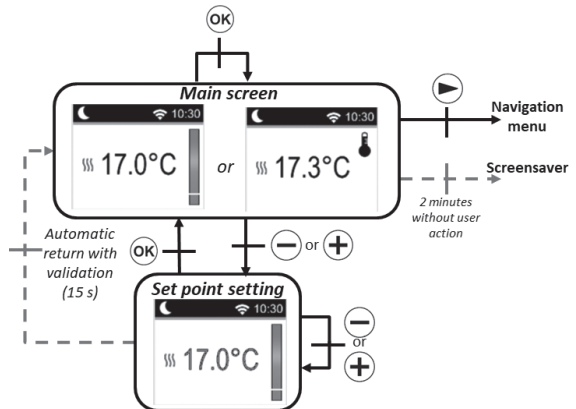

Intervalle: de 5,0°C à 19°C (ou point de consigne inférieur 0,5°C si inférieur).





Mode automatique Auto

Dans ce mode, le thermostat suivra le programme choisi (de P1 à P9 intégré ou de U1 à U2 personnalisé) selon le temps réel et la température de configuration Confort  et réduite .

Sur la page-écran principale, la touche  permet de passer de l'affichage de la température mesurée à celui de la température de configuration.

Si l'utilisateur appuie les touches  et , il peut ignorer, jusqu'à la prochaine phase du programme et pendant 2 heures, la température du programme en cours en changeant la valeur. La valeur commence à clignoter et elle peut être modifiée.



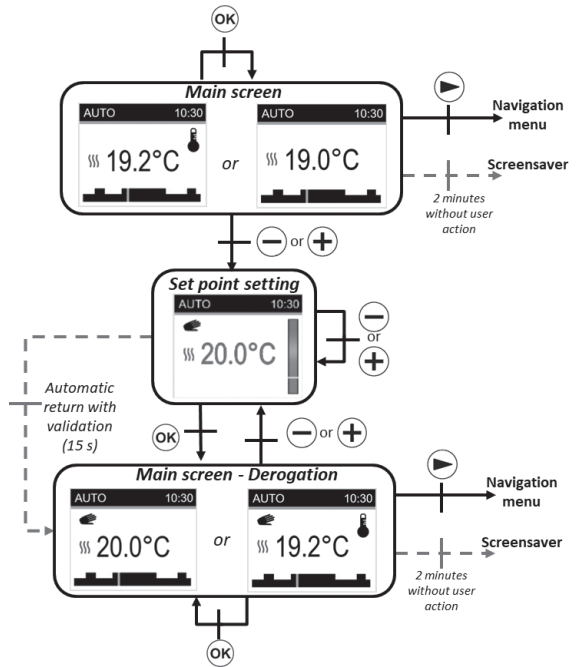

Si vous appuyez sur la touche  ou en attendant 15 seconds sans faire aucune action, la valeur du point de consigne est validée. Le symbole de la main s'affiche lorsque la fonction de dépassement est activée. Ce dépassement continue jusqu'à la phase successive (le programme passe à un autre point de consigne de la température) ou pendant 2 heures au maximum.

Si vous appuyez sur la touche , vous affichez le menu de navigation.

Si vous appuyez sur la touche , le thermostat s'éteint.



Mode Hors-gel

Dans ce mode, hors-gel le point de consigne de la température sera suivi tout le temps. Sur la page-écran principale, si vous appuyez sur les touches  et , le point de consigne de la température hors-gel commence à clignoter et peut être modifiée. Si vous appuyez sur la touche  ou en attendant 15 seconds sans faire aucune action, le point de consigne de la valeur est validée. Sur l'économiseur d'écran (rétroéclairage activé),  permet de changer l'affichage de température mesurée à configuration de la température.

Si vous appuyez sur la touche , le menu de navigation s'affiche.

Si vous appuyez sur la touche , le thermostat est éteint.



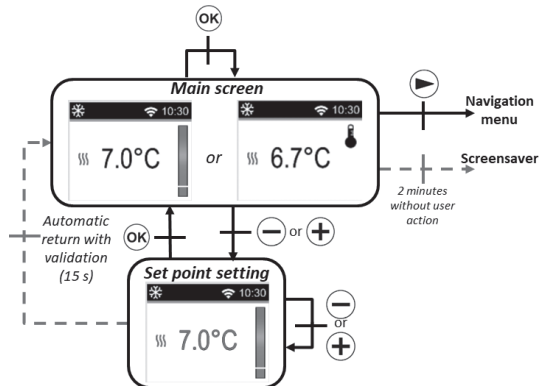

Valeur prédéfinie: 7°C

Intervalle: de 0,5°C à 10°C.



Mode Arrêt chauffage

En mode Arrêt Chauffage le symbole s'affiche en mode OFF .

Après avoir appuyé sur l'une des 4 touches ( ou  ou  ou ) , la température mesurée s'affiche.

Après quelques secondes, cette information n'est plus affichée.

Ce mode applique une température de référence zéro.

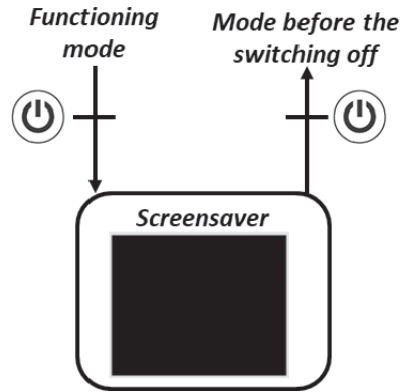

Si vous appuyez sur la touche , le thermostat se réactive dans le dernier mode sélectionné.



Mode Boost

Ce mode permet aux utilisateurs d'augmenter le chauffage avec la température maximum configurée pendant une intervalle de temps préconfiguré.

Configuration du temps:

La valeur temporelle se configure à l'aide des touches  et . La touche permet de valider la valeur temporelle et la période d'augmentation rapide.

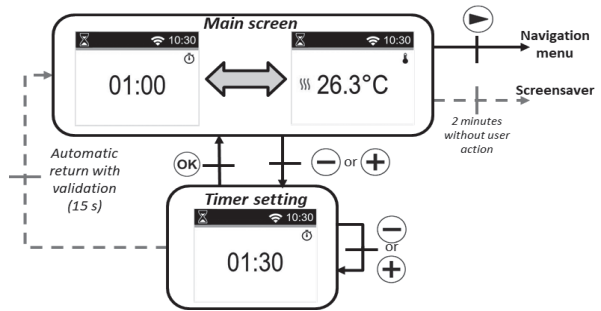

Valeur prédéfinie: 1 heure

Intervalle des valeurs : 30 minutes, de 1H à 24 H passage de 1 heure.

Lorsque le boost est activé, le temp restant et la température mesurée s'affichent.

Si vous appuyez sur  ou  vous pouvez modifier les configurations.

Si vous appuyez sur  pendant une seconde vous accéder au menu de sélection du mode.

Si vous appuyez sur  vous arrêtez le produit et remettez à zéro la minuterie.

Définition du menu «CONFIGURATION»

Lorsque l'utilisateur accède au menu «CONFIGURATION» il peut choisir entre différents groupes de paramètres ou actions:

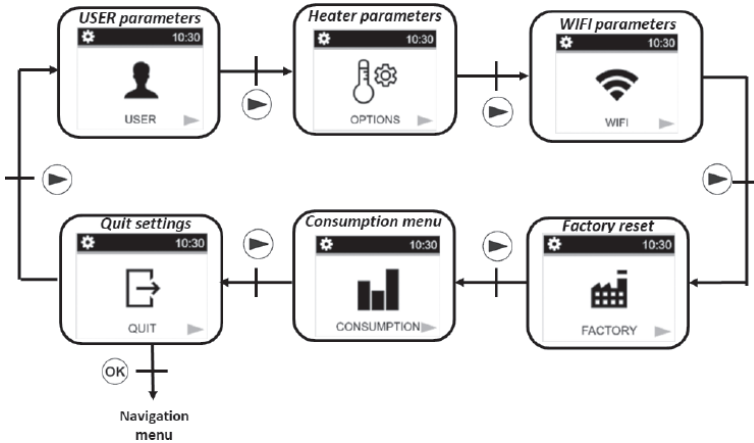

Pour sélectionner un menu, l'utilisateur doit appuyer sur la touche **OK**. La navigation est réalisée par la touche **▶**. Pour sortir du menu paramètres, l'utilisateur doit choisir le paramètre «SORTIR» et appuyer sur la touche **OK**.

Une autre façon de sortir du menu des paramètres consiste à appuyer sur **▶** sans lâcher la touche pendant quelques secondes.

Paramètres utilisateur

La sélection du menu de configuration des paramètres se fait en appuyant sur la touche **▶**.

La configuration se fait en appuyant sur la touche **OK**. Pour sortir du menu paramètres, l'utilisateur doit choisir le paramètre «SORTIR» et appuyer sur la touche **OK**.

Une autre façon de sortir du menu des paramètres consiste à appuyer sans la lâcher sur **▶** pendant quelques secondes.



| | |
|--|---|
| <p>Écran «UNITS» affichant un pictogramme de thermostat et le mot «UNITS» en bas à droite.</p> | <p>Type de degrés affichés «UNITES»</p> <p>Valeur prédéfinie: °C (Celsius) Autres choix: °F (Fahrenheit)</p> |
|--|---|

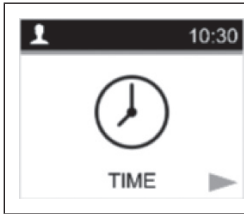

Menu «DATE ET HEURE» pour configurer l'heure et la date

Il y a deux façons de configurer l'heure et la date du thermostat en fonction de l'état du WIFI (activé ou non):

PREMIÈRE MÉTHODE: WIFI DÉSACTIVÉ

Modification de l'heure:

Sélectionnez les heures et les minutes avec la touche **▶**. Modifiez le chiffre des valeurs avec les touches **–** et **+**.

Confirmez vos configurations avec la touche **OK**.

Format horaire:

Sélectionnez le format 24H ou AM / PM avec les touches **–** et **+**. Confirmez vos configurations avec la touche **OK**.

Changement d'heure automatique:

Sélectionnez si le changement d'horaire (horaire d'été/hiver) aura lieu automatiquement ou non à l'aide des touches **–** et **+**. Confirmez vos configurations avec la touche **OK**.

Modification de la date:

Sélectionnez le jour ou le mois ou l'année avec la touche **▶**. Modifiez les valeurs avec les touches **–** et **+**. Confirmez vos configurations avec la touche **OK**.

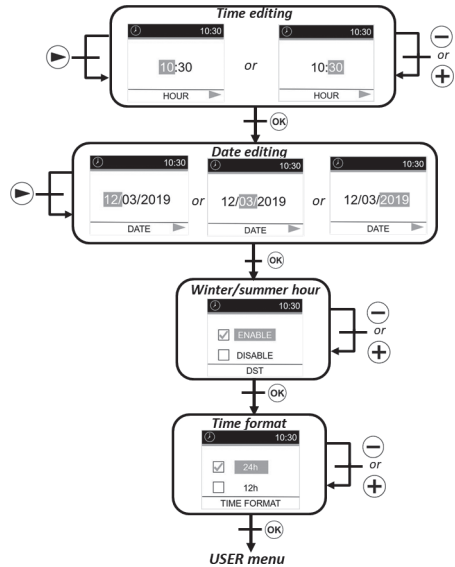

DEUXIÈME MÉTHODE: WIFI ACTIVÉ

Fuseau horaire:

Sélectionnez le fuseau horaire mondial avec les touches **–** et **+**. Validez votre réglage à l'aide de la touche **OK**.

Format de l'heure:

Sélectionnez le format 24H ou AM/PM avec les touches **–** et **+**. Validez votre réglage à l'aide de la touche **OK**.

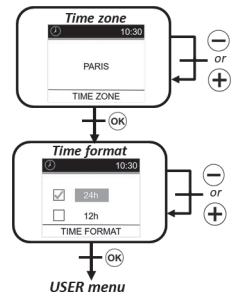

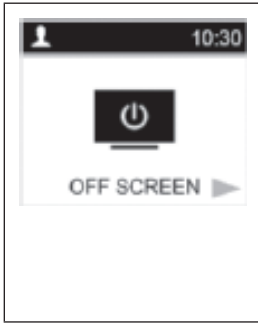

Ecran OFF

Quand aucun mode n'est actif, sur l'écran du thermostat s'affichent les écrans suivants

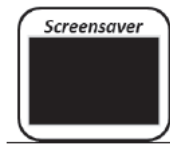
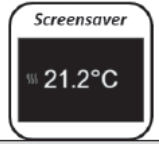

Valeur prédéfinie: Aucun

Autres choix: Température mesurée (7h00 à 23h00)

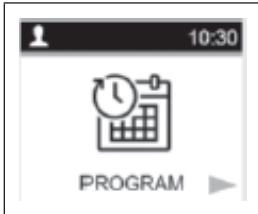

Programme

Ce menu permet de sélectionner le programme à appliquer en mode AUTO.

Programme:

Sélectionner «Sélection» avec la touche . Validez votre réglage à l'aide de la touche .

Sélection:

Sélectionner le numéro du programme avec la touche Sélectionner le jour avec les touches et .

Validez votre numéro de programme avec la touche .

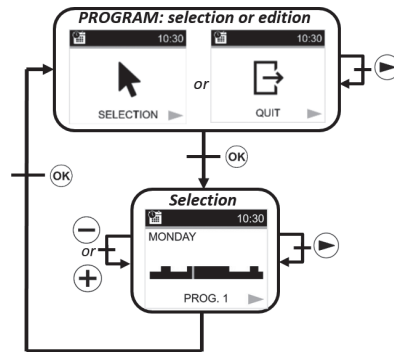

Sélection de la langue

Valeur par défaut: Anglais

Autres choix: Français



Sortir du menu paramètres

Si vous appuyez sur la touche vous sortez du menu paramètres UTILISATEUR et vous revenez au menu paramètres REGLAGES.

Options et paramètres du radiateur

La sélection du menu de configuration des paramètres se fait en appuyant sur la touche . La configuration se fait en appuyant sur la touche .

Pour sortir du menu paramètres, l'utilisateur doit choisir le paramètre «SORTIR» et appuyer sur la touche . Une autre façon de sortir du menu des paramètres consiste à appuyer sans la lâcher sur la touche pendant quelques secondes.

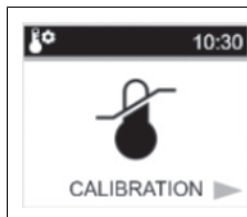
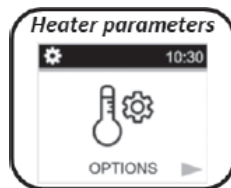

Étalonnage du capteur de température:

L'étalonnage doit être fait après 1 jour d'utilisation avec la même température de configuration, de la façon décrite ci-dessous:

1. Placez un thermomètre dans la pièce, à la même distance du sol que le thermostat. Contrôlez la température réelle dans la pièce après 1 heure.
2. Saisissez cette valeur dans le menu des paramètres d'étalonnage à l'aide des touches et pour saisir la valeur réelle.
3. Appuyez sur pour confirmer l'étalonnage.

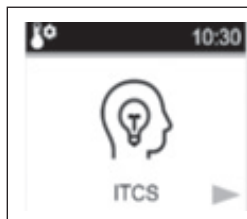

ITCS - Intelligent Temperature Control System (adaptive start heating in AUTO mode)

Cette fonction est décrite dans le paragraphe «Fonctions spéciales». Ce paramètre permet d'activer ou non cette fonction.

Valeur prédéfinie: Oui (activation fonction)
Autres choix: Non

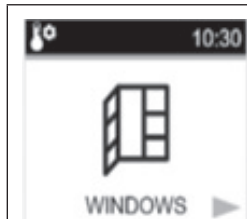

Détection automatique de la fenêtre ouverte

Cette fonction est décrite dans le paragraphe «Fonctions spéciales». Ce paramètre permet d'activer ou annuler cette fonction.

Valeur prédéfinie: Oui (activation fonction)
Autres choix: Non



Puissance chauffante

Ce paramètre correspond à la puissance du réchauffeur. Ce paramètre doit être configuré pour calculer la consommation d'énergie et pour sélectionner les paramètres de réglage.

Valeur prédéfinie: 900
Autres choix: 1000, 1500, 1800, 2000

| | |
|---|--|
|  | <p>Limite de puissance Ce paramètre permet de réduire la puissance du radiateur manuellement.</p> <p>Valeur prédéfinie: NON (100%) Autres choix: NON (100%)/75%/50%</p> |
|  | <p>Boost programmation températures Température point de consigne quand la commande boost est active.</p> <p>Valeur prédéfinie: 30°C Autres choix: 20°C à 30°C</p> |
|  | <p>Limitation de la température ambiante Limitation de la température ambiante maximale qui sera possible régler à distance.</p> <p>Valeur prédéfinie: 30°C Autres choix: 20°C à 30°C</p> |
|  | <p>Sortir du menu Paramètres Si vous appuyez sur la touche OK vous pouvez sortir du menu paramètres et revenir au fonctionnement normal.</p> |



Paramètres WIFI

La sélection du menu de configuration des paramètres se fait en appuyant sur la touche **▶**. La configuration se fait en appuyant sur la touche **OK**.

Pour sortir du menu paramètres, l'utilisateur doit choisir le paramètre «SORTIR» et appuyer sur la touche **OK**. Une autre façon de sortir du menu des paramètres consiste à appuyer sans la lâcher sur la touche **▶** pendant quelques secondes.

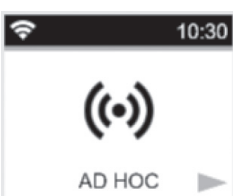

| | |
|---|---|
|  | <p>INFORMATIONS WIFI: Ce menu montre les informations du WIFI:</p> <ul style="list-style-type: none"> • Etat de la connexion: CONNECTE, Mode AD HOC, NON CONNECTE et CONNEXION; • SSID; • Adresse IP; • Adresse MAC. |
|---|---|

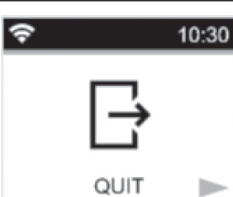
| | |
|---|--|
|  | <p>CONNEXION</p> <p>Active la connexion cloud du produit. Remarque : le produit doit être configuré avant en mode ad hoc activation de la connexion (cf. ci-dessous).</p> |
|  | <p>AD HOC (mode direct):</p> <p>Active le mode AD HOC, ce mode permet de configurer le produit réseau WIFI en utilisant l'application. Quand le thermostat fonctionne dans ce mode, l'utilisateur peut voir une antenne différente sur l'écran:</p>  |
|  | <p>WIFI OFF</p> <p>Désactivation de la connexion WIFI.</p> |
|  | <p>Reinitialisation WIFI</p> <p>Supprime toutes les connexions WIFI configurées.</p> |
|  | <p>Sortir du menu</p> <p>Appuyez sur la touche OK pour sortir du menu WIFI.</p> |

Remise à zéro des paramètres d'usine

Tous les paramètres du thermostat seront chargés avec les configurations d'usine.

Si vous appuyez sur la touche **OK**, le thermostat remet à zéro les paramètres

Le thermostat est ramené aux configurations d'usine prédéfinies:

- Températures nominales;
- REGLAGE paramètres;
- Rétablir l'heure;
- Consommation d'énergie;
- Paramètres WIFI.

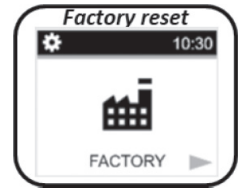

Menu enregistrement consommations

Ce mode n'est disponible que si la puissance du radiateur a été configurée par l'utilisateur.

Appuyez sur **▶** pour changer l'intervalle de temps pour l'affichage de la consommation d'énergie (dernières 24 heures, 7 derniers jours et dure 30 jours).

Si vous n'appuyez sur aucune touche, le thermostat revient automatiquement au vieux mode sélectionné.

Appuyez sur **OK** pour revenir au Menu CONFIGURATIONS.

Si vous appuyez pendant quelques secondes sur **-** ou **+** vous rétablissez les valeurs de la consommation d'énergie.

Une autre façon de sortir du menu des paramètres consiste à appuyer sans la lâcher sur la touche **▶** pendant quelques secondes. Si vous appuyez sur **⏻** vous arrêtez le produit.

Les valeurs estimées sont sauvegardées dans la mémoire toutes les 4 heures et chaque fois que l'utilisateur affiche ce menu.

Si la COUPURE d'énergie est active, les valeurs sont maintenues pendant les 12 heures successives.

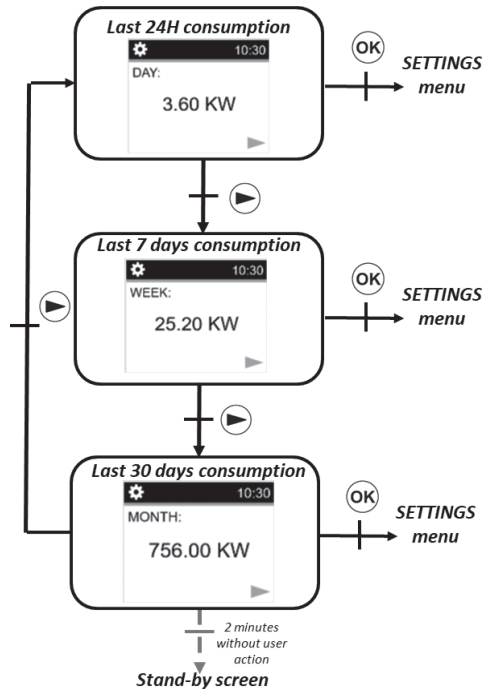

Description du programme intégré

- P1: matin (7h-9h), soir (17h-23h), et weekend (8h-23h)
- P2: matin (7h-9h), après-midi (12h-14h), soir (18h-23h) et weekend (8h-23h)
- P3: semaine (6h-23h), samedi (7h-24h) et dimanche (nuit (0h-1h), jour (7h-23h))
- P4: soir (15h-23h) et samedi (7h-24h) et dimanche (nuit (0h-1h), jour (7h-23h))
- P5: matin (6h-8h), soir (21h-23h) et samedi (matin 7h-9h), soir 18h-24h) et dimanche (matin (7h-9h), soir (18h-23h))
- P6: matin (6h-8h), après-midi (14h-21h) et weekend (7h-21h)
- P7: bureau du lundi au vendredi (7h-19h) et weekend (arrêt)
- P8: Magasin: du lundi au vendredi (de 8h - 19h) et le samedi (de 8h à 18h) et le dimanche (arrêt)
- P9: Résidence secondaire: vendredi (13h) à lundi (7h)

Sauvegarde configurations

Ce thermostat sauvegarde automatiquement ses données (valeurs du point de consigne, programme utilisateur et configurations) quand :

1. L'utilisateur valide les modifications apportées aux configurations en appuyant sur la touche de validation.
2. Le rétroéclairage du produit s'éteint.

Il mémorise aussi les valeurs estimées de sa consommation d'énergie :

1. Toutes les 4 heures
2. Quant l'utilisateur entre dans le mode consommation.

Fonctions spéciales

ITCS : Système intelligent de contrôle de la température

Cette fonction peut être activée à l'aide du «paramètre ITCS» dans le paramètre menu (voir chapitre paramètre menu «Menu paramètres»).

Cette fonction permet d'activer votre installation à l'avance (2 heures maximum) lorsque votre thermostat est en mode Auto . Cette fonction assure la température désirée à l'heure programmée suivant votre programme hebdomadaire.

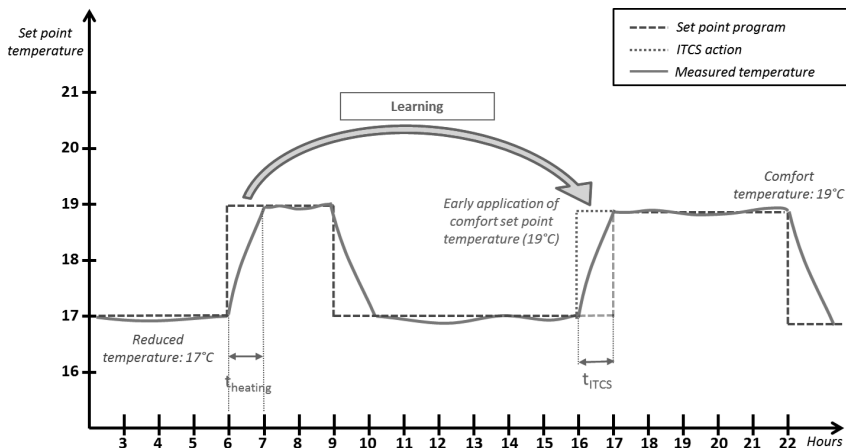

Pour fonctionner, le système ITCS réalise automatiquement plusieurs mesures de temps et de température. L'objectif est d'estimer une vitesse de chauffage du système. Avec cette valeur, le système peut calculer à l'avance le temps d'activation du chauffage. Lorsque le thermostat est mis en marche pour la première fois, une durée par défaut est utilisée pour atteindre la température de consigne. Cette valeur sera ajustée par de nouvelles mesures à chaque changement de programme pour compenser l'évolution de la température extérieure. Ensuite, le thermostat peut être programmé sans réglage car il se fera automatiquement. Lorsqu'un démarrage adaptatif est réalisé par le système, un logo de la main est affiché sur l'écran.

Detection fenetre ouverte

Cette fonction peut être activée avec le «paramètre fenêtre» dans le paramètre menu.

Cette fonction est exécutée en mesurant et en enregistrant l'évolution de la température au cours des 20 dernières minutes:

- Premier pas - Ouverture fenetre activée: le thermostat passe à l'état «Fenetre ouverte»  (et la valeur de la température clignote) lorsque au cours des 20 dernières minutes la température a baissé de plus de 1,5°C, quand le produit était allumé et en train de chauffer.
- Deuxième pas: pendant 20 minutes, si la température dépasse 0,3°C l'état d'ouverture de la fenetre est supprimé et la télécommande revient automatiquement au point de consigne du mode en cours.

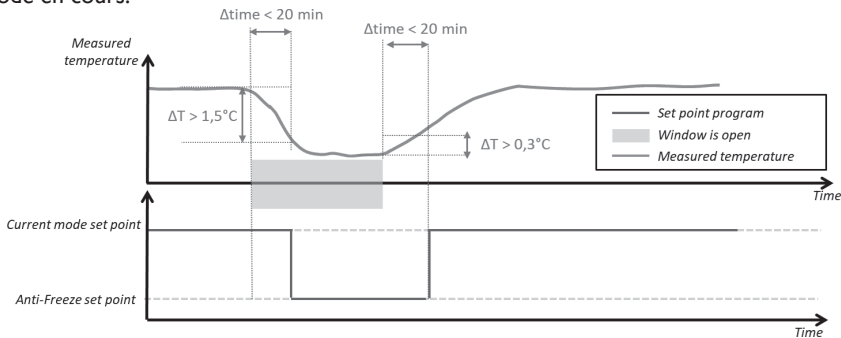
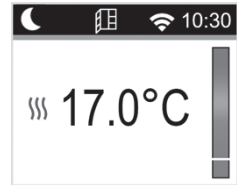

Sauvegarde des données en cas de coupure de courant prolongée

Ce produit peut maintenir le décompte du temps pendant 12 heures après une coupure de courant.

Si la coupure de courant dure trop longtemps, les valeurs de l'heure et de la date seront ramenées aux valeurs d'usine. Vous devrez reconfigurer ces valeurs.



Verrouillage clavier

Pour activer cette fonction, vous devez appuyer en même temps sur les touches \ominus ou \oplus pendant 5 secondes. Toutes les touches sont verrouillées sauf Marche / Arrêt chauffage ⏻ .

Cette fonction est accessible dans n'importe quel mode.

L'icône 🔒 s'affiche sur l'écran:

Pour déverrouiller le clavier, vous devez répéter la même procédure.

REMARQUE: en cas de panne de courant la configuration est maintenue.



Mode controle fil-pilote

| Commande fil-pilote | Page-écran afficheur | Commande fil-pilote | Page-écran afficheur |
|---------------------|----------------------|---------------------|----------------------|
| Confort | | Réduite | |
| Confort -1° | | Hors-gel | |
| Confort -2° | | Arrêt | |

Priorité dans les ordres du fil pilote

| Thermostat current mode | Pilote wire order | Applied mode |
|-------------------------------------|-----------------------|---|
| AUTO mode (comfort ☀️) | Comfort | Comfort |
| | Comfort -1° | Comfort -1° |
| | Comfort -2° | Comfort -2° |
| | Comfort -3.5°/reduced | Lower between Comfort -3.5° and 19°C |
| | Antifreeze | Antifreeze |
| AUTO mode (reduced 🌙) | Comfort | Reduced setpoint temperature |
| | Comfort -1° | |
| | Comfort -2° | |
| | Comfort -3.5°/reduced | Lower between Reduced set point temperature and "Comfort -3.5°" |
| | Antifreeze | Antifreeze |
| AUTO mode (derogation 🖱️) | Comfort | Derogation setpoint temperature |
| | Comfort -1° | |
| | Comfort -2° | |
| | Comfort -3.5°/reduced | |
| | Antifreeze | |
| | Stop | Stop |

Si la détection de la fenêtre ouverte 🪟 est activée et si cette fonction détecte l'ouverture, le thermostat suit les règles présentées dans le paragraphe «Détection fenêtre ouverte». Le thermostat affiche la valeur de la température configurée appliquée au réchauffeur. Il prend en considération l'ordre de priorité présenté précédemment.

Description des erreurs

Si le capteur est éteint ou débranché, un message d'erreur s'affiche sur l'écran du thermostat.

| | | |
|----------------------------|---|--|
| Problème sur le capteur |  | Le message «-» montre le Logo 🌡️ clignotant et le logo ⚠️ sur l'afficheur. |
| Problème de connexion WIFI |  | Un logo rouge WIFI s'affiche. |

APPLICATION POUR MOBILE (SMARTPHONE)

Généralités

L'application est disponible que pour les plateformes IOS et Android.



L'application permet de configurer la partie WIFI et de contrôler à distance le radiateur. Tout d'abord télécharger l'application gratuit « DELTACALOR CONFORT »



sur votre mobile (smartphone).

Avec l'application l'utilisateur peut ajouter un dispositif à l'application et configurer le réseau WIFI.

1. Cliquez sur «liste de mes installations» pour montrer l'installation existante ou ajouter une nouvelle installation.

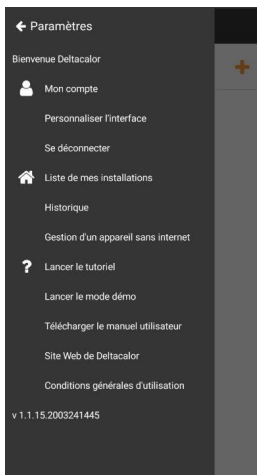

2. Cliquez sur «plus» pour ajouter un nouveau dispositif.

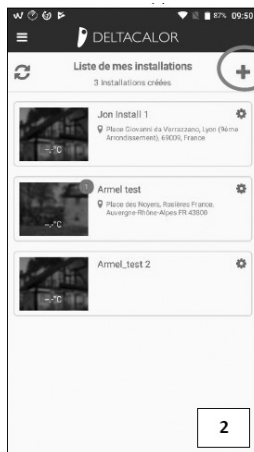

3. Attendez la connexion WIFI.

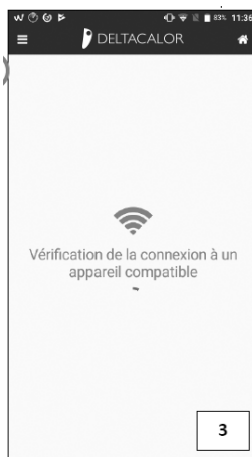

4. Si le smartphone n'est pas connecté sur le produit, accédez aux configurations WIFI du téléphone en cliquant sur configuration WIFI. Revenez ensuite à l'application.



5. Créez l'installation, la nouvelle pièce et ajoutez le nom du dispositif.

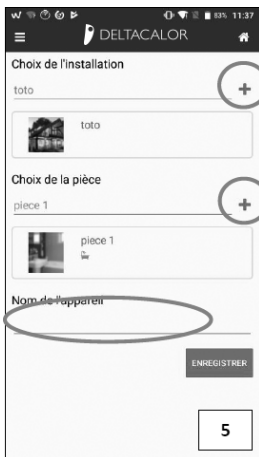

6. Sauvegardez la configuration.



7. Connectez le produit sur Internet, choisissez le réseau et saisissez le mot de passe.



8. Appuyez sur la touche jusqu'au terme de la configuration du réseau du dispositif.



Vous pouvez être dans un mode Éco, Hors-gel, ou en mode Auto avec un abaissement imposé par le gestionnaire d'énergie.

Passer en mode Confort permanent ou augmentez la consigne.

- Vérifiez si votre appareil n'est pas près d'une prise d'air.
- Vérifiez si la température réglée n'a pas été modifiée.

QUE FAIRE EN CAS DE PROBLÈMES

L'appareil ne chauffe pas assez.

- Vous pouvez être dans un mode Éco, Hors-gel, ou en mode Auto avec un abaissement imposé par le gestionnaire d'énergie. Passez en mode Confort permanent ou augmentez la consigne.

L'appareil chauffe continuellement.

- Vérifiez si votre appareil n'est pas près d'une prise d'air.
- Vérifiez si la température réglée n'a pas été modifiée.

Si le problème persiste, coupez l'alimentation électrique du radiateur et attendez au moins une minute avant de faire le reset. Si le problème persiste, contactez votre installateur.

VIDEO TUTORIAL



Suivez les instructions de la notice, ou consultez le tutoriel vidéo en encadrant le QR code ici sur le côté, avec votre smartphone.

CARACTÉRISTIQUES TECHNIQUES

| | | |
|---------------------------------|--|---|
| Produit | Radiateur électrique | |
| Applications | Chauffage domestique | |
| Classe d'isolation | CLASSE II | |
| Classe IP | IP24 | |
| Couleur plastique | Blanc | |
| Câble d'alimentation Couleur | Blanc | |
| Sélection de la température | Numérique | |
| Mode de réglage | Numérique avec 5 boutons | |
| Mode de fonctionnement | Confort, Nuit, Hors gel, ECO, Chrono, Vacances, Détection fenêtre ouverte, Protection enfant, Contrôle adaptatif de départ, Verrouillage des touches | |
| Plage de température | 0.5 + 30°C | |
| Puissance maximale | 2000W | |
| Bande de fréquence | 2400MHz to 2483.5MHz | |
| Tension d'alimentation | 230Vac 50Hz | |
| Connexions électriques | 3 câbles: neutre (gris), phase (Brown), Fil-Pilote (Noir) | |
| Garantie | 2 ans | |
| Standard | EN 60335-1 EN 61000-3-2 EN 62233 EN 55014-1 NFC 15-100 | EN 60335-2-30 EN61 000-3-3 EN 55014-2 |

Fabricant: DELTACALOR s.r.l.

Manual d'instruction disponible sur le site:

<https://www.deltacalor.com/fr/telechargement/>

Le symbole , posé sur l'appareil, signale l'obligation de se débarrasser de l'appareil en le confiant à un centre de collecte sélective spécialisé, conformément à la Directive 2012/19/UE. Si l'appareil doit être remplacé, il peut être retourné au revendeur. Cet appareil n'appartient pas à la catégorie des déchets ménagers ordinaires. En l'éliminant correctement vous participez à la protection de l'environnement et à la limitation de l'exploitation des ressources naturelles.

Déclaration de conformité: Le fabricant déclare, sous son exclusive responsabilité, que le produit concerné par le présent manuel est conforme aux prescriptions essentielles des Directives Basse Tension 2014/35/UE, CEM 2014/30/UE et RoHS 2011/65/UE.



| modèle 1000 W | | | |
|---|-------------|---------|-------|
| Caractéristique | Symbole | Valeur | Unité |
| Puissance thermique | | | |
| Puissance thermique nominale | P_{nom} | 1,0 | kW |
| Puissance thermique minimale (indicative) | P_{min} | n.d. | kW |
| Puissance thermique maximale continue | $P_{max,c}$ | 1,0 | kW |
| Consommation d'électricité auxiliaire | | | |
| À la puissance thermique nominale | el_{max} | 1,0 | kW |
| À la puissance thermique minimale | el_{min} | n.d. | kW |
| En mode veille | el_{SB} | <0,0005 | kW |

| modèle 1500 W | | | |
|---|-------------|---------|-------|
| Caractéristique | Symbole | Valeur | Unité |
| Puissance thermique | | | |
| Puissance thermique nominale | P_{nom} | 1,5 | kW |
| Puissance thermique minimale (indicative) | P_{min} | n.d. | kW |
| Puissance thermique maximale continue | $P_{max,c}$ | 1,5 | kW |
| Consommation d'électricité auxiliaire | | | |
| À la puissance thermique nominale | el_{max} | 1,5 | kW |
| À la puissance thermique minimale | el_{min} | n.d. | kW |
| En mode veille | el_{SB} | <0,0005 | kW |

| modèle 2000 W | | | |
|---|-------------|---------|-------|
| Caractéristique | Symbole | Valeur | Unité |
| Puissance thermique | | | |
| Puissance thermique nominale | P_{nom} | 2,0 | kW |
| Puissance thermique minimale (indicative) | P_{min} | n.d. | kW |
| Puissance thermique maximale continue | $P_{max,c}$ | 2,0 | kW |
| Consommation d'électricité auxiliaire | | | |
| À la puissance thermique nominale | el_{max} | 2,0 | kW |
| À la puissance thermique minimale | el_{min} | n.d. | kW |
| En mode veille | el_{SB} | <0,0005 | kW |



SAFETY INSTRUCTIONS



- Any damage resulting from non-compliance with these instructions causes the non application of the manufacturer's warranty.
- Do not use the device outdoors.
- Your device is intended for a domestic use and must not be used for other purposes.
- If the device is dropped, damaged or does not work correctly, do not turn on the unit and make sure that the power supply on the device is switched off (fuse or circuit breaker).
- Never disassemble the device. A poorly repaired device can present risks for the user.
- Contact your retailer for any problem.
- If the power cable is damaged, it must be replaced by the manufacturer, his after-sales service or another professional, to avoid all danger.
- Caution: the power cable must not touch the heater body.
- The heater must be installed in such a way that the switches and other control devices can not be affected by a person in the bathtub or under the shower (ref.: NF C15-100 standard).
- The heater must not be installed below a plug.
- The power supply circuit of this device must have a device omnipolar cutoff (ref: NF C15-100 standard).
- Warning: In order to avoid overheating, do not cover the device. If the device is covered, the rise in temperature will activate the built-in protection device.



Do not cover



WARNINGS FOR PEOPLE WITH DISABILITIES AND CHILDREN



- This equipment may not be used by people with reduced physical, sensory, or mental capacity, those without any knowledge of the equipment, or children over 8 years of age, unless supervised and instructed on safe use of the equipment, and aware of all the risks.
- Children must not play with the equipment.
- Cleaning and maintenance tasks must not be done by children without supervision.
- We recommend keeping the device out of reach of children below 3 years of age, unless under constant adult supervision.
- Children between 3 and 8 may only switch the device on and off, providing it is installed regularly in the stipulated position, that the children are under constant adult supervision or have been instructed in the safe use of the equipment, and that they fully understand potential dangers.
- Children between 3 and 8 must not set up, regulate or clean the device, nor undertake maintenance on it.

WARNING

In order to avoid any hazard to young children, it is recommended to install the unit so that the lower radiant bar is at least 600 mm above the floor.



WARNING FOR WIFI THERMOSTAT





The device allows remote control through a WI-FI connection
It is mandatory to respect a minimum distance of at least 20 cm
from the habitable area for humans.





CHILDREN SAFETY

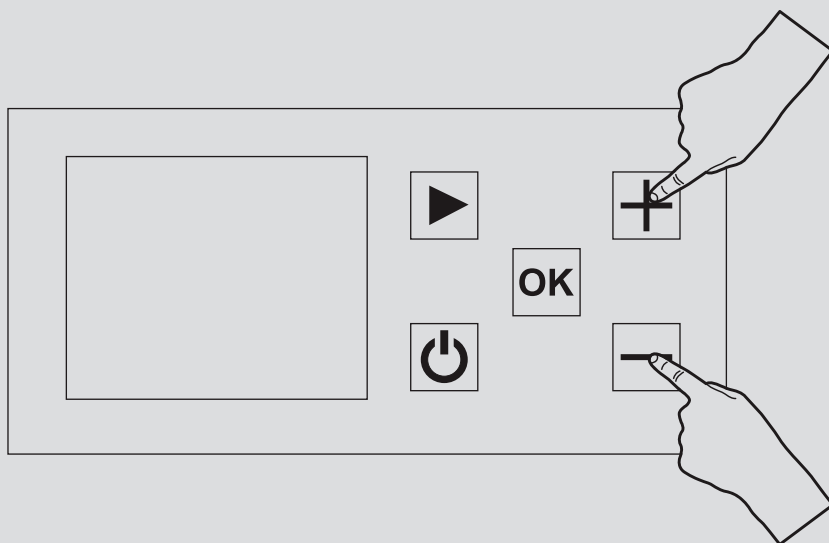

Locking the keypad «»

To lock or unlock the keypad, simultaneously push keys  and  for 5s.



This function is used to lock the keypad, excepting for the On/Off key .

In this mode it is not possible to change the program configuration, the temperature or activate the other functions.

INSTALLING THE DEVICE

Before connecting the heater, turn off the electricity at the general circuit breaker.

- The heater is a class II appliance, so it can be installed in all rooms of the house (IP24). You should check the protection grade (IPXX) of your own appliance.
- You should consult with expert personnel the chance to install the appliance in bathrooms or locals in whose there's current water.
- The heater must be installed 15 cm minimum of any obstacle (shelves, curtains, furniture etc.).

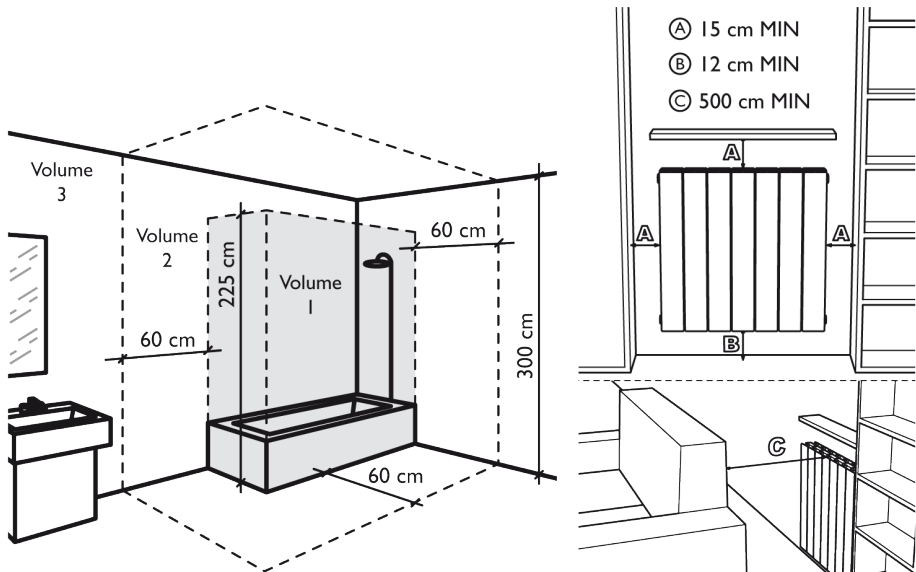

POWER SUPPLY AND ELECTRICAL CONNECTIONS

- The power supply to the heater must be protected, according to the standards in force, by a 30 mA differential switch and a protection device against overcurrents adapted to the characteristics of the connecting line.
- Before the first use, check that the voltage used corresponds to the one indicated on the device.
- This heater is a Class II appliance (double electrical insulation).
- The connection to earth is prohibited.
- **The three wires must be connected** in one electrical connection box complies with the standards in force.
- **You must isolate the pilot wire if it is not used.**

- Single phase power supply 230 V ~ ± 10% 50 Hz.

- Blue / gray thread: Neutral
- Brown Wire: Phase
- Black wire: Pilot wire

FIXINGS THE WALL BRACKETS

1. Before mounting the radiator to the wall, check that the distances shown in the drawings “INSTALLING THE DEVICE” are respected (see p.5).
2. Determine by looking at the table here below your radiator model and respect the heights and width indicated to mount the wall brackets For help with installation, refer to drawings 1 and 2 (see next page).

| Potenza | H | L |
|----------------|---|----------|
| 1000 W | 207 mm | 220 mm |
| 1500 W | 207 mm | 420 mm |
| 2000 W | 207 mm | 620 mm |
| | H = Height fixing holes L = Width fixing holes | |

3. Secure the brackets to the wall using cleats (not supplied) adapted to the wall structure on which the radiator is positioned.
4. Once fixed, close the security system with the screws as indicated on drawing 3 (see next page)..

NOTE

Screws and tiles are not supplied

NOTE

Screws and tiles are not supplied



4 x V

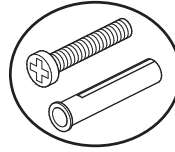

Use the supplied fixing template

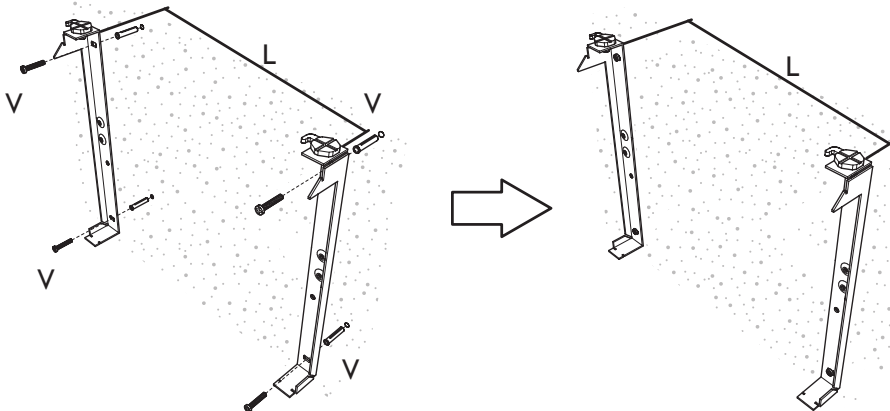
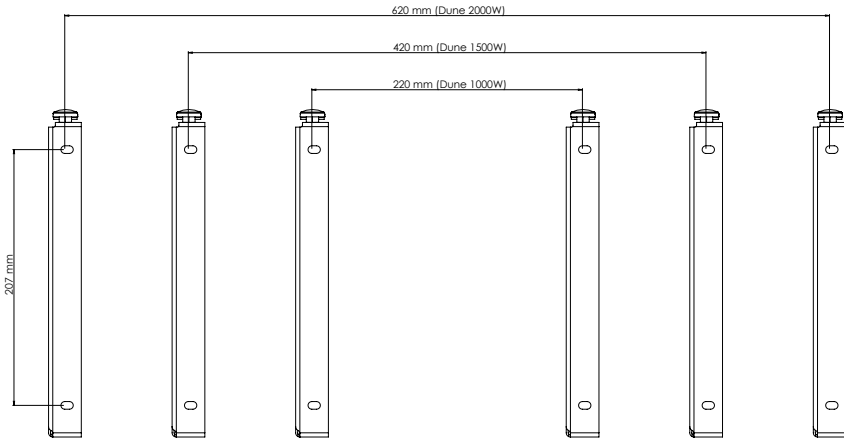

3

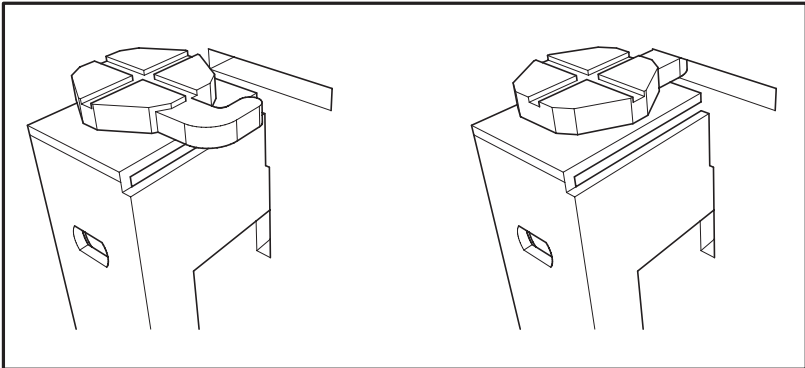
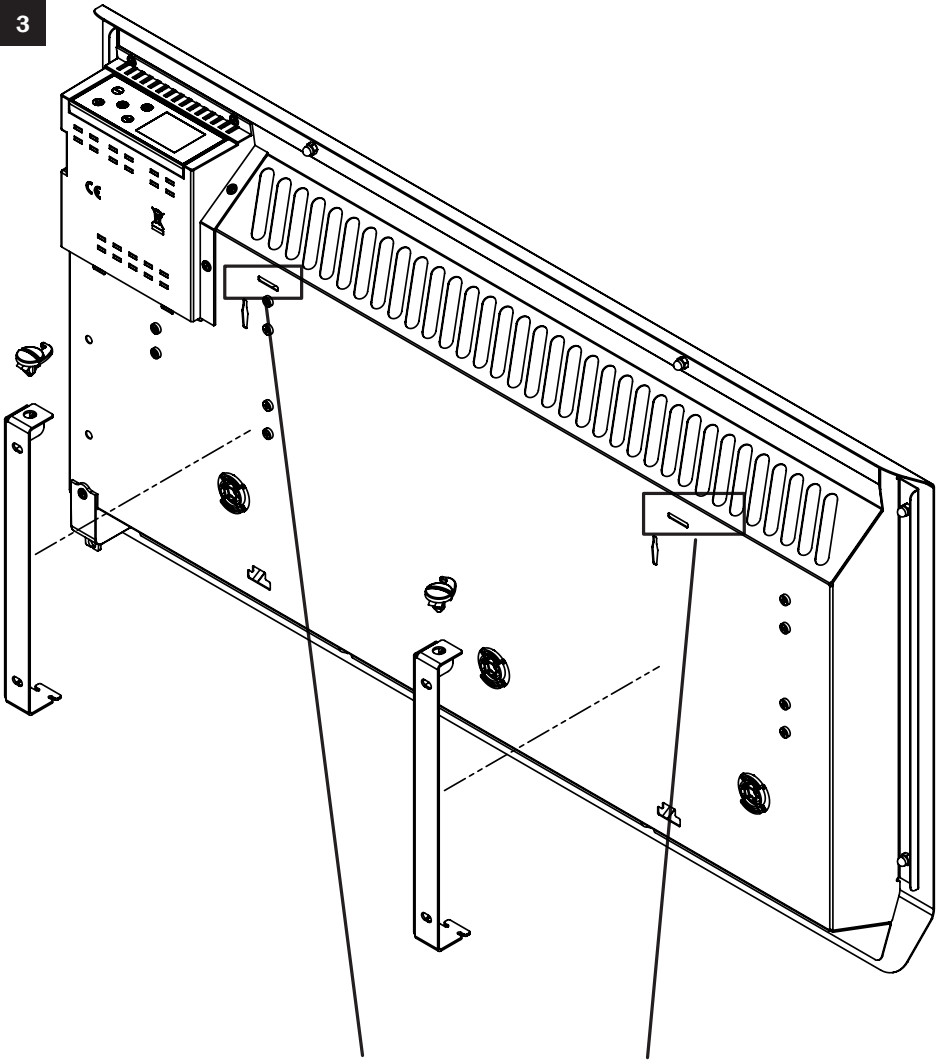

POWER SUPPLY AND ELECTRICAL CONNECTIONS

Use the product as shown in Figure 1. Do not ever put towels or clothing on the outer frame (figure 2). Incorrect use may cause dangerous overheating and compromise the operation of the device.

To clean the unit, do not use any chemicals, but use a damp, non-abrasive cloth.

1



2

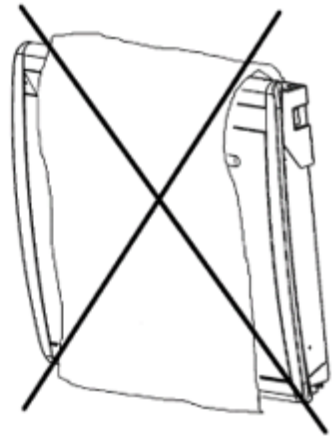

USER INTERFACE FEATURES

Display

The display is backlit.

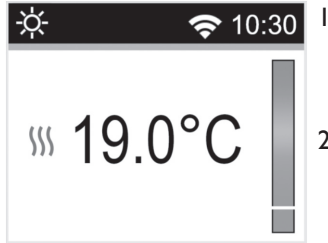

1 - Information on the operating mode/thermostat menu, time and WiFi connection.

2 - Information on:

- Thermostat operating mode: temperature setting, behaviour indicator, measured temperature, radiator heating indicator.
- Parameter setting: Display of the actual value of the settings made.
- Programme selection for mode AUTO.

The keypad has 5 keys:

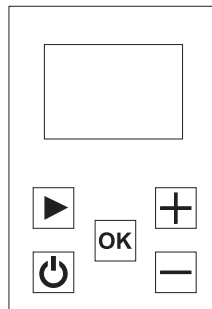

| | |
|--|------------------------------------|
| | ON / OFF button (Heating on / off) |
| | minus key |
| | Validation button |
| | Plus key |
| | Navigation key |

FIRST SWITCHING ON AND INSTALLATION

When the thermostat is switched on or after the unit has been reset/reset, this first screen is displayed.

The number corresponds to the software version of the unit.

The second screen depends on the status of the thermostat:

- The first time the unit is started, the user will be able to directly configure the WIFI connection, the date and time of day.

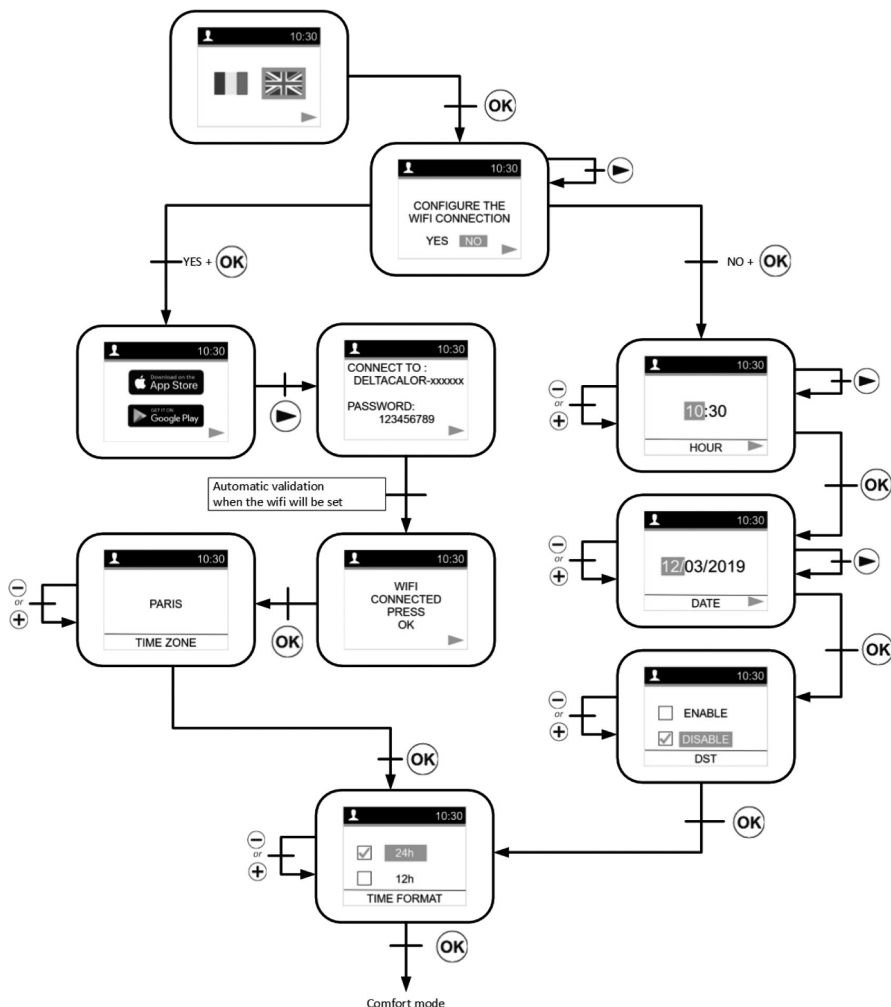

To configure a radiator and associate it to your WIFI network with the “DELTACALOR CONFORT” application go to page 62.

After a power cut, this will be the screen page of the current mode.

After a unit reset or a very long power cut, the screen page of the modification time will be displayed.

MODE SELECTION MENU

To change the current mode of the thermostat, the user must press the right navigation key to access the menu selection.

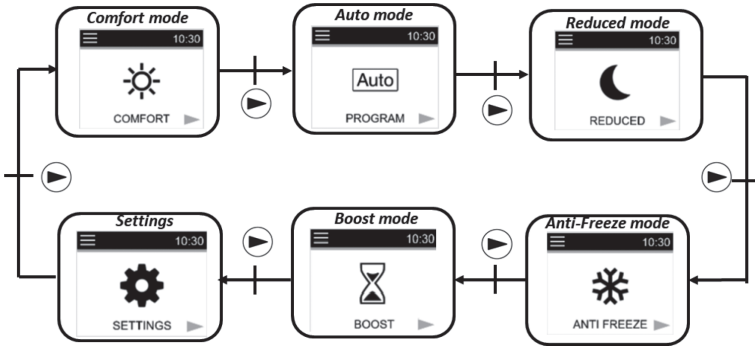

The user moves the frame cursor to select a working mode.

To select a mode, press **OK**.

Confirm the selected mode by pressing the key **OK** aotherwise the thermostat will automatically return to the last selected mode **☒**, **☒**, **☒**, **☒** **Auto**.





By touching **⏪**, users can access the heating on/off mode immediately:

If there is no activity on the keypad for 5 to 10 seconds, a screen saver is displayed
This screen saver could be the value of the measured or zero temperature:



Definition of operating modes

Comfort mode

In this mode, temperature of the comfort setting will be followed all the time. On the screen saver (backlighting on), if you press the key  or , keys, the set temperature for comfort starts flashing and you can change it. If you press the  key or wait 15 seconds without taking any action, the value of the setting is confirmed. This setting will be used in **Auto** mode during the high phase of the selected programme.  From the screen saver (backlight on) if you press 

you can switch the display from the measured temperature to the set temperature. If you press the , key, the navigation menu will be displayed.



If you press the , key, the thermostat is deactivated.

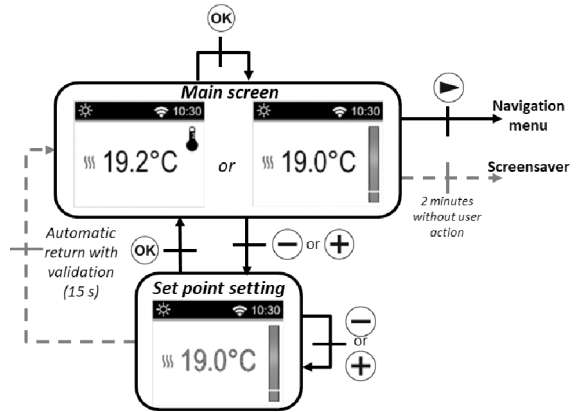

Preset value: 19°C.

Interval: 10°C to 30°C. (the maximum value can be changed in the settings menu).



Eco mode

In this mode, the unit operates at a reduced configured temperature. On the screen saver (backlighting activated), if you press on key  or , the reduced configuration temperature starts flashing and you can change it.

If you press the  key or wait 15 seconds without taking any action, the value of the setting is activated. This setting will be used in mode **Auto** during the high phase of the selected programme .

On the screen saver (backlight on), the  allows you to switch the display to from the measured temperature to the set temperature

If you press the , key, the navigation menu will be displayed.

If you press the , key, the thermostat is deactivated.

Preset value: 17°C.

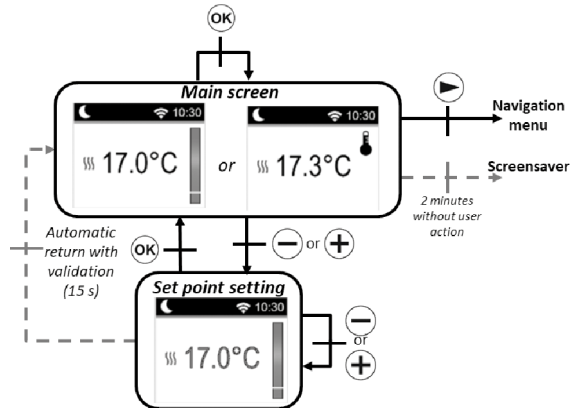

Range: 5.0°C to 19°C (or 0.5°C lower set temperature if lower).



Automatic mode Auto

In this mode, the thermostat will follow the chosen programme (from P1 to P9 integrated or from U1 to U2 customised) according to the real time and the Comfort and reduced  set temperature.

On the main screen, the key  enables you to switch from the display of the measured temperature to the set temperature.

If the user presses the keys  and , they can ignore the temperature of the current programme for up to 2 hours by changing the value. The value starts flashing and can be changed.

If you press the  key or wait 15 seconds without taking any action, the value of the setting is confirmed. The symbol of a hand is displayed when the



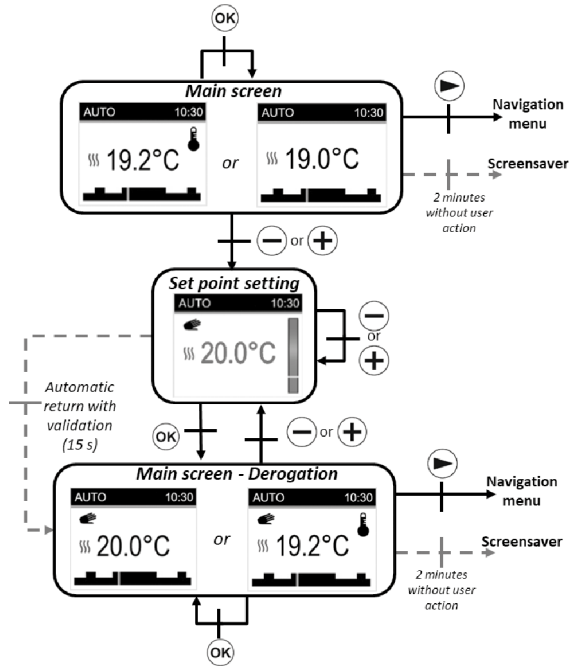

override function is activated. This override continues until the next phase (the programme switches to another temperature setpoint) or for a maximum of 2 hours.

If you press the  key, the navigation menu will be displayed.

If you press the  key, the thermostat will switch off.



Frost protection mode

In this mode, frost protection, the temperature setting will be monitored all the time. On the main screen, if you press the  and  keys, the frost protection temperature setting will start to flash and can be changed. If you press the  key or wait 15 seconds without taking any action, the setting point of the value is confirmed. On the screen saver (backlighting activated),  you can change the measured temperature display to the set temperature.

If you press the  key, the navigation menu is displayed.

If you press the  key, the thermostat is turned off.



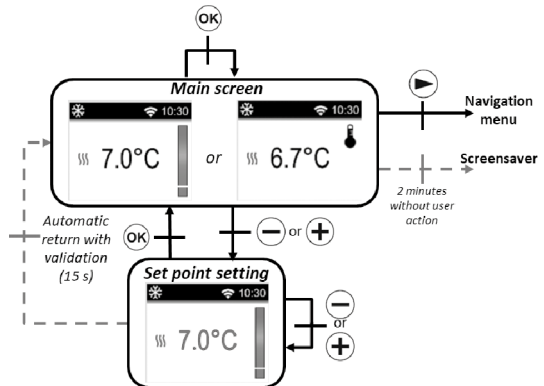

Preset value: 7°C

Interval: from 0.5°C to 10°C.



Heating Off mode

In Heating Off mode, the symbol is displayed in OFF mode .

After pressing one of the 4 key (   ) , the measured temperature is displayed.

After a few seconds, this information is no longer displayed.

This mode applies a zero reference temperature.

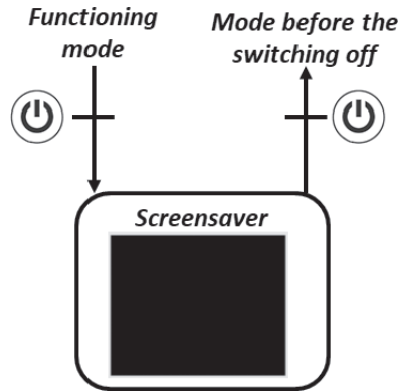

If you press the , key, the thermostat reactivates in the last selected mode.



Boost mode

This mode allows users to increase the heating with the set maximum temperature for a preset time interval.

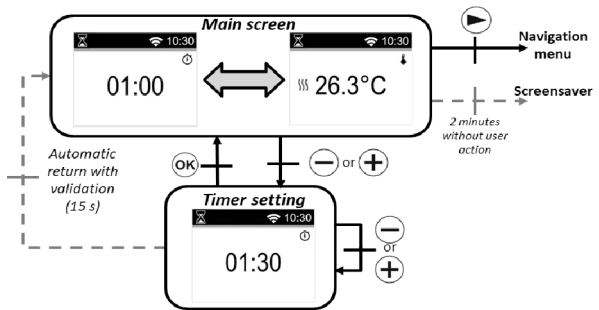

Time configuration:

The time value is set using the  and  keys. The key is used to confirm the time value and the period for which the temperature increases rapidly



Preset value: 1 hour

Interval of values: 30 minutes, from 1 hour to 24 hours, 1 hour intervals.

When the boost is activated, the remaining time and the measured temperature are displayed. If you press  or  you can change the settings.

If you press  for one second you will access the menu for selecting the mode.

If you press , you stop the unit and reset the timer.

Definition of the “CONFIGURATION” menu

When the user accesses the “CONFIGURATION” menu, they can choose between different groups of settings or actions:

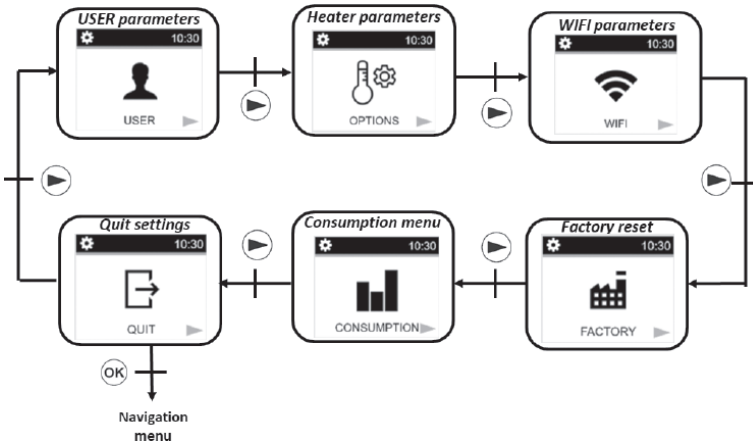

To select a menu, the user must press the **OK** key. Navigation is performed via the **▶** key. To exit the settings menu, the user must choose the “EXIT” setting and press the **OK** key. Another way to exit the settings menu is to press **▶** without releasing the key for a few seconds.

User settings

The setting configuration menu is selected by pressing the **▶** key. The configuration is done by pressing the **OK** key. To exit the settings menu, select the “EXIT” setting and press the **OK** key. Another way to exit the settings menu is to press and hold the key **▶** for a few seconds.



| | |
|--|--|
| | <p>Degrees measurements units «UNITS»</p> <p>Preset value: °C (Celsius) Other choice: °F (Fahrenheit)</p> |
|--|--|

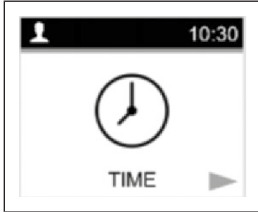

Menu «DATE AND TIME» to configure the time and date.

There are two ways to configure the time and date of the thermostat depending on the WIFI status (activated or not):

FIRST METHOD: WIFI OFF

Changing the time:

Select the hours and minutes with **▶**. Change the number of the values with keys **-** and **+**. Confirm your settings with the **OK** key.

Time format:

Select the 24H or AM / PM format with the **-** and **+** keys. Confirm your configurations with **OK** key.

Automatic time change:

Select whether the time change (summer/winter time) will take place automatically or not using **-** and **+** keys. Confirm your settings with the key **OK**.

Changing the date:

Select the day or month or year with **▶**. Change the values with keys **-** and **+** keys. Confirm your settings with the key **OK**.

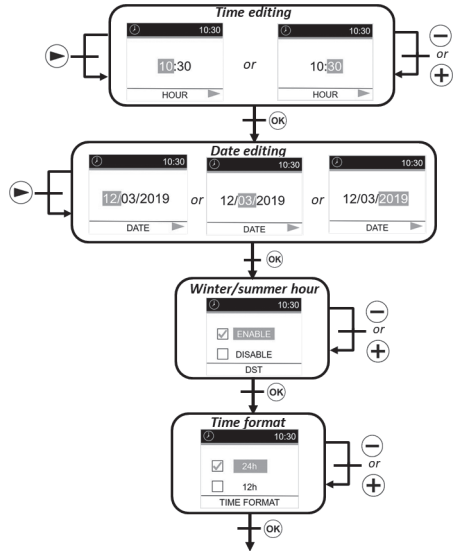

SECOND METHOD: WIFI ON

Time zone:

Select the world time zone with the **-** and **+** keys. Confirm your settings with the key **OK**.

Time format:

Select the 24H or AM/PM format with the **-** and **+** keys. Confirm your settings with the key **OK**.

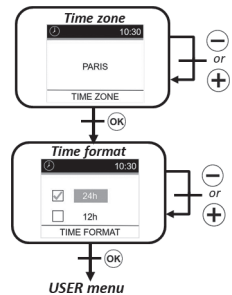

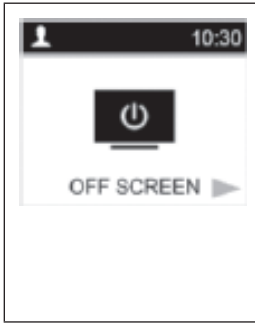

VIDEO SCREEN OFF

When no mode is active, the screen appears as below:

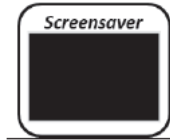
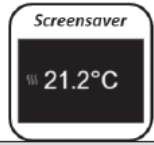

Default value: none

Other choice: Measured temperature (7h00 to 23h00)

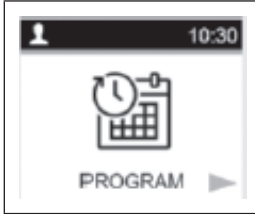

Program

this menu allows you to select the programming to be applied in auto mode AUTO.

Program:

Select "Selection" with the . Confirm your settings with the key .

Selection:

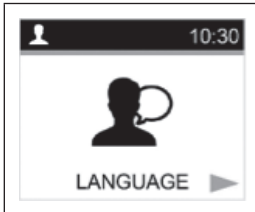
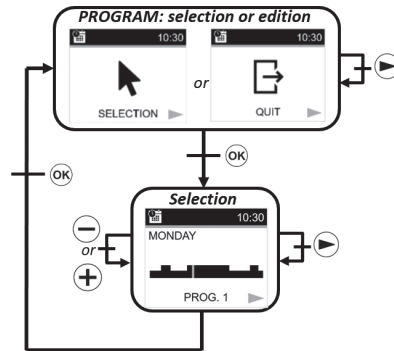

Select the programme number with the key . Select the day with the keys and . Confirm your settings with the key .





Language selection



Default value: English

Other choice: French, Italian, German and Spanish



| | |
|---|--|
|  | <p>Exit the settings menu If you press the key  you can exit the USER settings menu and return to the SETTINGS menu.</p> |
|---|--|

Heater options and settings

To select the setting configuration menu, press the  Lkey. The configuration is done by pressing the  key.

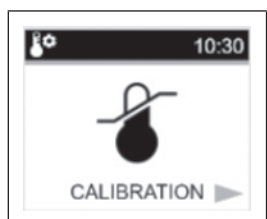

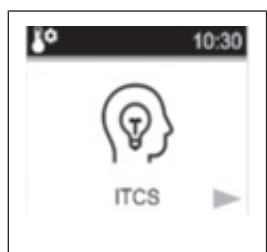

To exit the settings menu, the user must choose the setting "EXIT" and press the  key. Another way to exit the settings menu is to press and hold the  key for a few seconds.

| | |
|---|--|
|  | <p>Calibrating the temperature sensor: Calibration must be done after 1 day of use with the same configuration temperature, as described below:</p> |
|---|--|

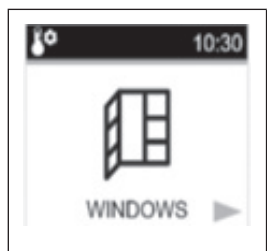
1. Place a thermometer in the room, at the same distance from the floor as the thermostat. Check the actual room temperature after 1 hour.
2. Enter this value in the calibration settings menu using the keys  and  to enter the actual value.
3. Press  to confirm the calibration.

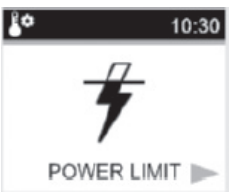
| | |
|--|---|
|  | <p>ITCS - Intelligent Temperature Control System (adaptive start heating in AUTO mode) This function is described in "Special functions". This setting activates or disables this function.</p> <p>Preset value: Yes (function activation) Other options: No</p> |
|--|---|

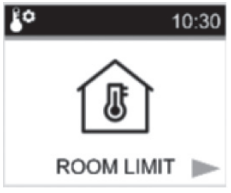
| | |
|---|---|
|  | <p>Automatic detection of an open window This function is described in "Special functions". This setting allows you to enable or disable this function.</p> <p>Preset value: Yes (function activation) Other options: No</p> |
|---|---|





| | |
|--|---|
|  <p>The screen shows a lightning bolt icon and the text 'POWER' with a right-pointing arrow. The top status bar contains a gear icon, a thermometer icon, and the time '10:30'.</p> | <p>Heating power This setting corresponds to the power of the heater. This setting must be configured to calculate the energy consumption and to select the setting parameters.</p> <p>Preset value: 900 Other options: 1000, 1500, 1800, 2000</p> |
|  <p>The screen shows a lightning bolt with a diagonal slash through it and the text 'POWER LIMIT' with a right-pointing arrow. The top status bar contains a gear icon, a thermometer icon, and the time '10:30'.</p> | <p>Power limit This setting allows the radiator power to be reduced manually.</p> <p>Preset value: NO (100%) Other options: NO (100%)/75%/50%</p> |
|  <p>The screen shows an hourglass icon and the text 'SETPOINT BOOST' with a right-pointing arrow. The top status bar contains a gear icon, a thermometer icon, and the time '10:30'.</p> | <p>Boost temperature programming Temperature setting when the boost control is active.</p> <p>Preset value: 30°C Other options: 20°C to 30°C</p> |
|  <p>The screen shows a house icon with a thermometer inside and the text 'ROOM LIMIT' with a right-pointing arrow. The top status bar contains a gear icon, a thermometer icon, and the time '10:30'.</p> | <p>Room temperature limitation Limitation of the maximum room temperature that can be set remotely.</p> <p>Preset value: 30°C Other options: 20°C to 30°C</p> |
|  <p>The screen shows a square icon with a right-pointing arrow and the text 'QUIT' with a right-pointing arrow. The top status bar contains a gear icon, a thermometer icon, and the time '10:30'.</p> | <p>Exit the Settings menu If you press the OK key you can exit the settings menu and return to normal operation</p> |

WiFi setting

To select the setting configuration menu, press the **▶** key. The configuration is done by pressing the **OK** key.

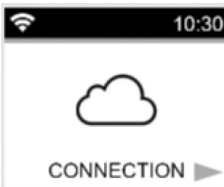
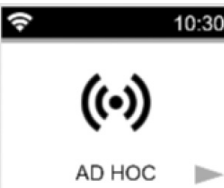
To exit the settings menu, the user must choose the setting "EXIT" and press the **OK** key. Another way to exit the settings menu is to press and hold the **▶** key for a few seconds.

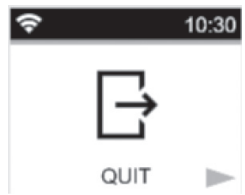

| | |
|---|---|
|  | <p>WIFI INFORMATION:</p> <ul style="list-style-type: none"> • This menu shows the WIFI information: • Connection status: CONNECT, AD HOC mode, NOT CONNECTED and CONNECTION; • SSID; • IP address; • MAC address. |
|  | <p>CONNECTION</p> <p>Activates the unit's cloud connection. Note: The unit must be configured beforehand in ad hoc connection activation mode (see below).</p> |
|  | <p>AD HOC (direct mode):</p> <p>Activates the AD HOC mode. This mode allows the WIFI network unit to be configured using the application. When the thermostat is operating in this mode, the user can see a different antenna on the display:</p>  |
|  | <p>WIFI OFF</p> <p>Deactivation of the WIFI connection.</p> |
|  | <p>RESTORE WIFI SETTINGS</p> <p>delete all configured WIFI connections.</p> |

| | |
|---|---|
|  | <p>EXIT THE MENU Press the button OK to exit the WIFI menu.</p> |
|---|---|

Reset to factory settings

All thermostat settings will be loaded with the factory settings. If you press the **OK**, key, the thermostat resets the settings to the factory default settings. The thermostat is reset to the predefined factory settings:

- Nominal temperatures;
- SETTINGS;
- Reset the time;
- Energy consumption;
- WIFI settings.

Consumption recording menu

This mode is only available if the radiator power has been configured by the user.

Press **▶** to change the time interval for the power consumption display (last 24 hours, last 7 days and lasts 30 days).

If you do not press any key, the thermostat will return automatically to the previously selected mode.

Press **OK** to return to the Menu CONFIGURATIONS.

If you press **-** or **+** for a few seconds, the power consumption values are restored.

Another way to exit the settings menu is to press and hold the **▶** key for a few seconds.

If you press **⏻** you stop the unit.

The estimated values are saved in the memory every 4 hours and every time the user displays this menu.

If POWER OFF is active, the values are maintained for the next 12 hours.

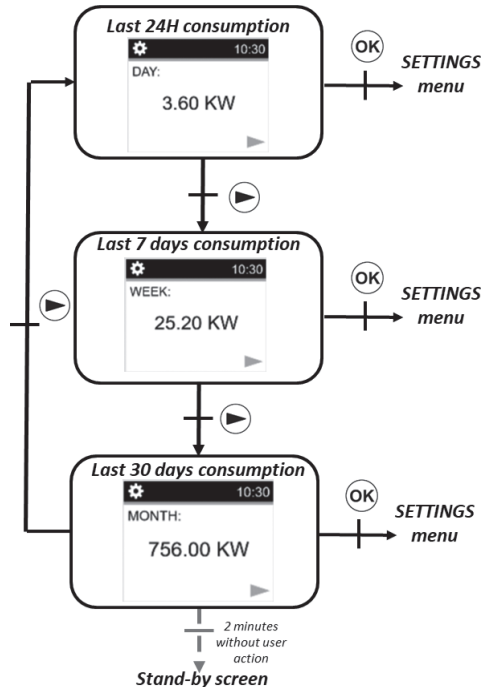

Description of the integrated program

- P1: morning (7h-9h), evening (17h-23h), and weekend (8h-23h)
- P2: morning (7h-9h), noon (12h-14h), evening (18h-23h) and weekend (8h-23h)
- P3: day (6h-23h), Saturday (7h-24h) and Sunday (night (0h-1h), day (7h-23h))
- P4: evening (15h-23h) and Saturday (7h-24h) and Sunday (night (0h-1h), day (7h-23h))
- P5: morning (6h-8h), evening (21h-23h) and Saturday (morning 7h-9h), evening 18h-24h) and Sunday (morning (7h-9h), evening (18h-23h))
- P6: morning (6h-8h), noon (14h-21h) and weekend (7h-21h)
- P7: office from Monday to Friday (7h-19h) and weekend (off)
- P8: Warehouse: from Monday to Friday (8h - 19h) and Saturday (8h - 18h) and Sunday (off)
- P9: Second house: from Friday (1pm) to Monday (7am)

Backup of settings

This thermostat automatically saves its data (set point values, user programme and settings) when:

1. The user confirms the changes made to the settings by pressing the confirmation button.
2. The unit's backlighting is switched off.

It also saves the estimated values of its energy consumption:

1. Every 4 hours
2. When the user enters the consumption mode

Special functions

ITCS: Intelligent temperature control system

This function can be activated using the "ITCS setting" in the settings menu (see chapter menu setting "Settings menu").

This function allows you to activate your system in advance (2 hours maximum) when your thermostat is in Auto mode. This function ensures the required temperature at the scheduled time according to your weekly programme.

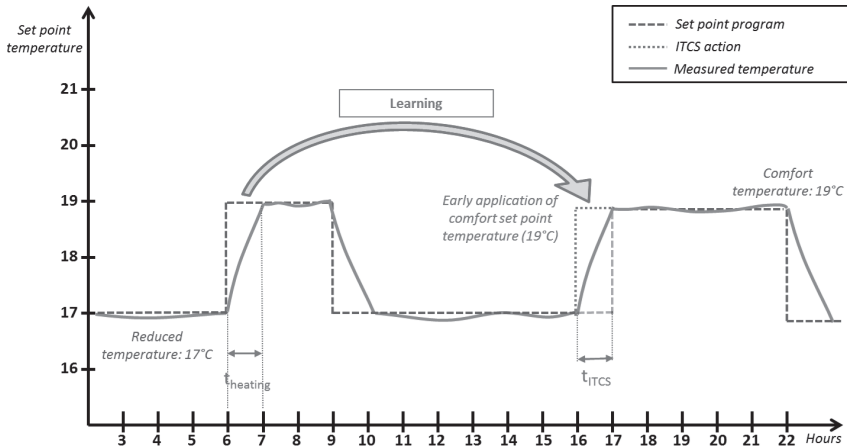

To operate, the ITCS system automatically performs several time and temperature measurements. The objective is to estimate a heating rate for the system. With this value, the system can calculate the heating activation time in advance.

When the thermostat is switched on for the first time, a default time for reaching the set temperature is applied. This value will be adjusted by new measurements each time the programme is changed to compensate for changes in the outdoor temperature. Afterwards, the thermostat can be programmed without adjustment because it will do so automatically.

When the system performs an adaptive start, a hand logo is displayed on the screen.

Open window detection

This function can be activated with the “window setting” in the menu setting.

This function is performed by measuring and recording the temperature development over the last 20 minutes:

- First step - Window open activated: the thermostat switches to the “Window open”  (status (and the temperature value flashes) when the temperature has dropped
- by more than 1.5°C in the last 20 minutes, when the unit was switched on and is heating.
- Second step: for 20 minutes, if the temperature exceeds 0.3°C, the window opening status is cancelled and the remote control automatically returns to the current mode setting

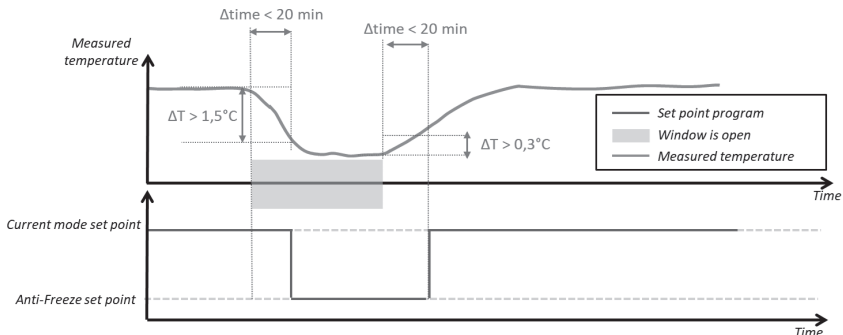
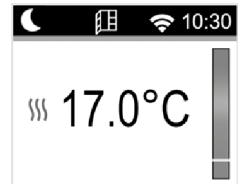

Saving data in the event of prolonged power failure

This unit can maintain the time countdown for up to 12 hours after a power failure.

If the power failure lasts too long, the time and date will be reset to the factory settings. You will need to reset these value



Keyboard lock

To activate this function, you must press the or keys simultaneously for 5 seconds. All the keys are locked except the heating On / Off key.

This function is accessible in any mode. The icon is displayed on the screen:

To unlock the keypad, you must repeat the same procedure. NOTE: In the event of a power cut, the configuration is maintained.

Pilot wire control mode

| Pilot wire command | Screen | Pilot wire command | Screen |
|--------------------|--------|-----------------------|--------|
| Comfort | | ECO | |
| Comfort-1° | | Frost protection mode | |
| Comfort -2° | | Stand-by | |



Priority in pilot wire sequences

| Mode set on the thermostat | Pilot wire control mode | Actual mode set |
|----------------------------|-------------------------|--|
| MODE AUTO (comfort) | Comfort | Comfort |
| | Comfort -1°C | Comfort -1°C |
| | Comfort -2°C | Comfort -2°C |
| | Comfort -3.5°C / eco | Lower value between Comfort -3.5°C and 19°C |
| | Antifreeze | Antifreeze |
| | Stop | Stop |
| MODEAUTO (eco) | Comfort | Temperature set in ECO mode |
| | Comfort -1°C | |
| | Comfort -2°C | |
| | Comfort -3.5°C / eco | Lower value between the temperature set in ECO mode and "Comfort -3.5 ° C" |
| | Antifreeze | Antifreeze |
| | Stop | Stop |
| MODE AUTO (manual) | Comfort | Manually set temperature |
| | Comfort -1°C | |
| | Comfort -2°C | |
| | Comfort -3.5°C / eco | |
| | Antifreeze | |
| | Stop | |

If the open window detection  is activated and this function detects the opening, the thermostat follows the rules described in the paragraph "Open window detection". The thermostat displays the value of the set temperature applied to the heater. It takes into consideration the order of priority shown above.

Description of errors

If the sensor is turned off or disconnected, an error message will appear on the thermostat display.

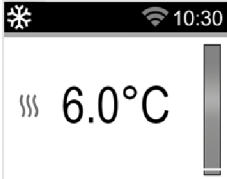
| | | |
|-------------------------|---|---|
| Sensor problem |  | the message «-» is accompanied by the icon  flashing and the logo on the display. |
| WIFI connection problem |  | The WIFI logo is red |

SMARTPHONE APPLICATION

General information

The application is only available for the IOS and Android platforms.



The application allows you to configure the WIFI component and remotely control the radiator. First of all download the free application "DELTACALOR COMFORT"



on your mobile (smartphone).

With the application the user can add a device to the application and configure the WIFI network.

1. Click on "list of my installations" to show the existing installation or add a new installation.

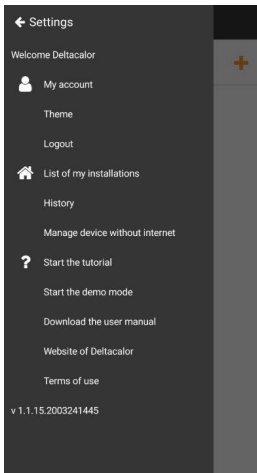

2. Click "more" to add a new device

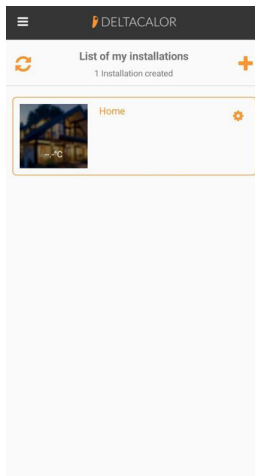

3. Wait for the WIFI to connect.

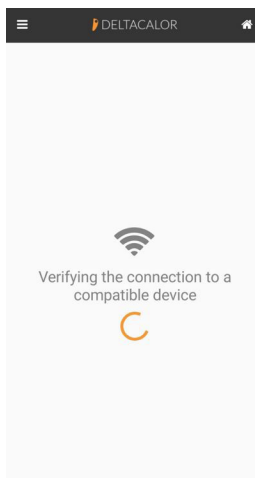

- If the smartphone is not connected to the unit, access the phone's WIFI settings by clicking WIFI setting. Then return to the application.

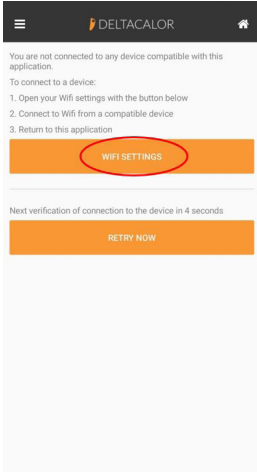

- Create the installation, the new room and add the name of the device.

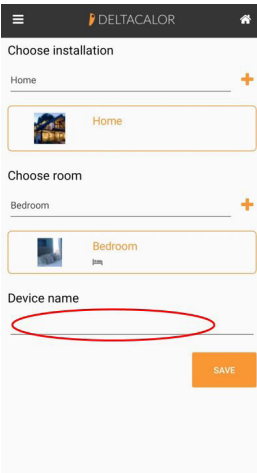

- Save the configuration

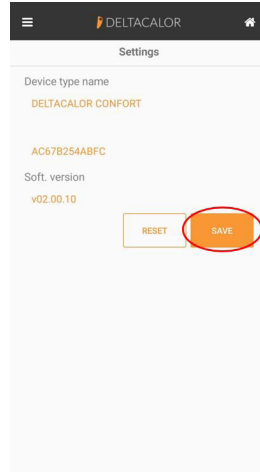

- Connect the unit to the Internet, select the network and enter the password.

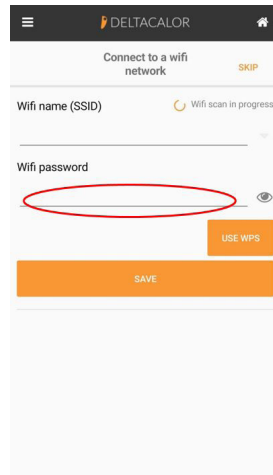

8. Press the key until the device network configuration is complete.

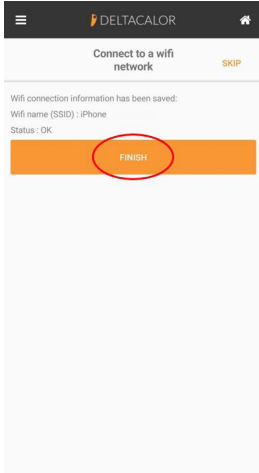

- You can be in Eco mode, Frost protection mode, or Auto mode with a reduction imposed by the power manager. Switch to Permanent Comfort mode or increase the setting.
- Check that your appliance is not near an air intake.
- Check that the set temperature has not been changed

TROUBLESHOOTING

The device does not heat enough

- The device could be set in ECO MODE or ANTI FREEZE. You should set the COMFORT mode or increase the setting temperature

The device heats continuously

- Check the position where the heater is installed: it should be far from any air flow.
- Check to be set the proper temperature.

If the problem persists you should interrupt the power supply to the heater and wait for one minute at least before turning it back on. If the problem persists again, please contact the technical assistance.

VIDEO TUTORIAL



Follow the instruction manual for pairing the Wi-Fi thermostat or watch the video tutorial linked to the QR code here at the side.

TECHNICAL FEATURES

| | | |
|-----------------------|--|---|
| Product | Electric radiator | |
| Application | Domestic use | |
| Insulation class | CLASS II | |
| IP Class | IP24 | |
| Plastic color | White | |
| Power cable color | White | |
| Temperature selection | Numeric | |
| Adjustment mode | Numeric with 5 buttons | |
| Operating mode | Comfort, Night, Antifreeze, ECO, Chrono, Vacation, Open window detection, Child protection, Adaptive start control, Key lock | |
| Temperature range | 0.5 + 30°C | |
| Maximum power | 2000W | |
| Frequency band | 2400MHz to 2484MHz | |
| Supply voltage | 230Vac 50Hz | |
| Electric connections | 3 cables: neutral (gray), phase (brown), Pilot wire (Black) | |
| Warranty | 2 anni | |
| Standard | EN 60335-1 EN 61000-3-2 EN 62233 EN 55014-1 NFC 15-100 | EN 60335-2-30 EN61 000-3-3 EN 55014-2 |

Manufacturer: DELTACALOR s.r.l

Instruction manual available on the site:

<https://www.deltacalor.com/en/download/>

The symbol  placed on the device indicates the obligation to dispose of the device by entrusting to a specialized selective collection center, in accordance with Directive 2012/19 / EU. If the device needs to be replaced, it can be returned to the dealer. This device does not belong to the category of ordinary household waste. By eliminating it correctly you participate in protecting the environment and limiting the exploitation of natural resources.

Declaration of conformity: The manufacturer declares, under his exclusive responsibility, that the product concerned by this manual conforms to the prescriptions of the Low Voltage Directives 2014/35 / EU, EMC 2014/30 / EU and RoHS 2011/65 / EU.



Model reference (s): DUNE

| mode 1000 W | | | |
|-----------------------------------|-------------|---------|------|
| Features | Symbol | Value | Unit |
| Thermal power | | | |
| Nominal heat output | P_{nom} | 1.0 | kW |
| Minimum heat output (indicative) | P_{min} | n.d. | kW |
| Maximum continuous heat output | $P_{max,c}$ | 1.0 | kW |
| Auxiliary electricity consumption | | | |
| At nominal heat output | el_{max} | 1.0 | kW |
| At minimum heat output | el_{min} | n.d. | kW |
| In economy mode | el_{SB} | <0,0005 | kW |

| mode 1500 W | | | |
|-----------------------------------|-------------|---------|------|
| Features | Symbol | Value | Unit |
| Thermal power | | | |
| Nominal heat output | P_{nom} | 1.5 | kW |
| Minimum heat output (indicative) | P_{min} | n.d. | kW |
| Maximum continuous heat output | $P_{max,c}$ | 1.5 | kW |
| Auxiliary electricity consumption | | | |
| At nominal heat output | el_{max} | 1.5 | kW |
| At minimum heat output | el_{min} | n.d. | kW |
| In economy mode | el_{SB} | <0,0005 | kW |

| mode 2000 W | | | |
|-----------------------------------|-------------|---------|------|
| Features | Symbol | Value | Unit |
| Thermal power | | | |
| Nominal heat output | P_{nom} | 2.0 | kW |
| Minimum heat output (indicative) | P_{min} | n.d. | kW |
| Maximum continuous heat output | $P_{max,c}$ | 2.0 | kW |
| Auxiliary electricity consumption | | | |
| At nominal heat output | el_{max} | 2.0 | kW |
| At minimum heat output | el_{min} | n.d. | kW |
| In economy mode | el_{SB} | <0,0005 | kW |



PRESCRIZIONI DI SICUREZZA



- Qualunque danno derivante dalla mancata osservanza di queste prescrizioni determinerà l'annullamento della garanzia del fabbricante.
- Non utilizzare l'apparecchio all'esterno.
- Questo apparecchio è destinato ad un uso domestico e non deve essere impiegato per altri scopi.
- Se l'apparecchio cade, è danneggiato o non funziona, evitare di rimetterlo in funzione e verificare che la sua alimentazione elettrica sia interrotta (fusibile o disgiuntore).
- Non smontare in nessun caso l'apparecchio. Un apparecchio non correttamente riparato può esporre l'utente a vari rischi.
- Per qualunque problema, rivolgersi al proprio rivenditore di fiducia.
- Se il cavo di alimentazione è danneggiato, deve essere sostituito dal fabbricante, dal suo servizio di assistenza o da un tecnico qualificato, onde evitare qualsiasi pericolo.
- Attenzione: il cavo di alimentazione non deve toccare il corpo scaldante.
- Il radiatore non deve essere posizionato immediatamente al di sotto di una presa di corrente.
- L'apparecchio di riscaldamento deve essere installato in maniera tale che gli interruttori e gli altri dispositivi di comando non possano essere toccati da una persona presente nella vasca da bagno o sotto la doccia (rif. norma NF C15-100).
- L'impianto di alimentazione dell'apparecchio deve prevedere un dispositivo di interruzione omipolare (rif. norma NF C15-100).
- Avvertenza: per evitare il rischio di surriscaldamento, non coprire l'apparecchio. In caso contrario, l'aumento della temperatura attiverà il dispositivo di protezione interno.



Non coprire il radiatore



AVVERTENZE PER LE PERSONE DISABILI E I BAMBINI



- Questo apparecchio può essere utilizzato da persone con ridotte capacità fisiche, sensoriali, mentali o senza alcuna conoscenza del prodotto oppure da bambini di età non inferiore a 8 anni purché sorvegliati e istruiti sull'uso sicuro dell'apparecchio e consapevoli di tutti i rischi.
- I bambini non devono giocare con l'apparecchio.
- Le operazioni di pulizia e manutenzione non devono essere effettuate da bambini senza sorveglianza.
- Si consiglia di tenere fuori dalla portata dei bambini di età inferiore a 3 anni se non sottoposti a vigilanza continua.
- I bambini di età compresa tra 3 e 8 anni devono soltanto accendere o spegnere l'apparecchio, purché quest'ultimo sia installato nella posizione normale prevista e i bambini siano sottoposti a vigilanza continua o abbiano ricevuto istruzioni relative all'utilizzo dell'apparecchio in sicurezza e comprendano perfettamente i potenziali pericoli.
- I bambini di età compresa tra 3 e 8 anni non devono collegare, regolare o pulire l'apparecchio, né sottoporlo a manutenzione.

ATTENZIONE

**Alcune parti di questo prodotto possono diventare molto calde e causare ustioni.
Prestare una particolare attenzione in presenza di bambini e persone disabili**



AVVERTENZE PER TERMOSTATO WIFI



L'apparecchio permette il controllo a distanza attraverso una connessione WI-FI



É obbligatorio rispettare una distanza minima di almeno 20 cm dalla zona abitabile per l'uomo.





SICUREZZA BAMBINI

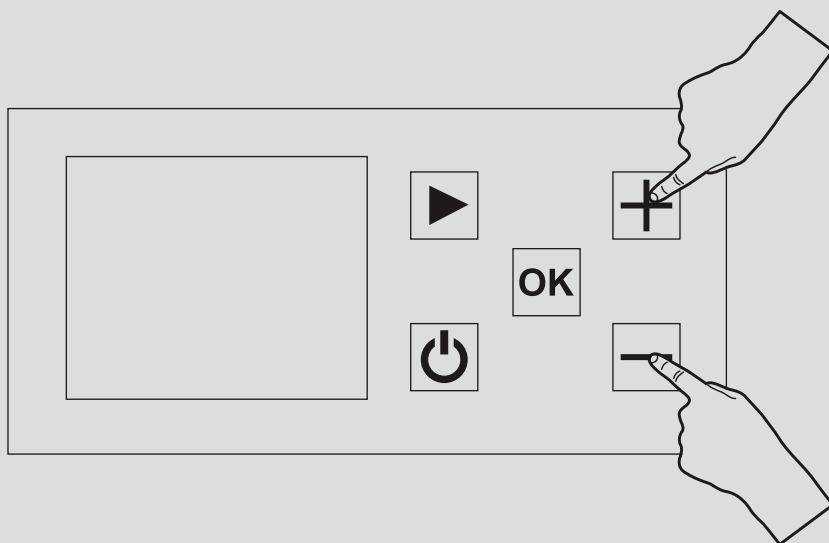

BLOCCO TASTI «»

Per attivare e disattivare la modalità blocco tasti premere contemporaneamente i tasti  e  per 5s.



Tutti i pulsanti sono bloccati tranne quello per il riscaldamento On / Off .

In questa modalità non è possibile modificare la configurazione del programma, la temperatura o attivare le altre funzioni.

PREPARAZIONE ALL'ISTALLAZIONE

Prima di collegare l'apparecchio di riscaldamento, disinnescare l'alimentazione elettrica generale.

Un apparecchio di classe II, può essere installato in tutte le stanze della casa (IP24). Si prega quindi di verificare il grado di protezione (IPXX) relativo al Vs. apparecchio.

Verificare con personale esperto la possibilità di installazione in bagni o comunque in locali con presenza d'acqua.

L'apparecchio di riscaldamento deve essere installato ad una distanza minima di 15 cm da qualunque ostacolo (scaffale, tendaggi, mobili, ecc.).

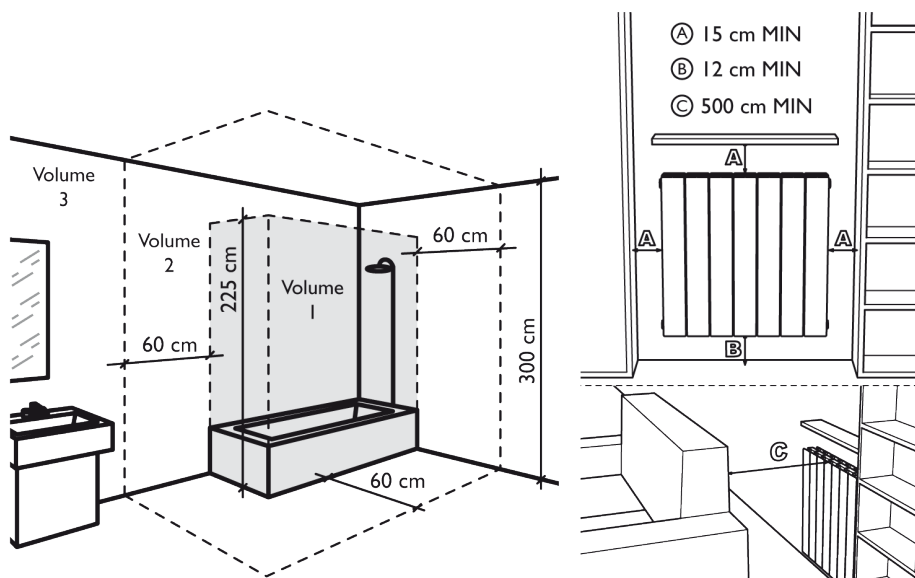

ALIMENTAZIONE E COLLEGAMENTI ELETTRICI

- Conformemente alle norme in vigore, l'alimentazione dell'apparecchio di riscaldamento deve essere protetta mediante un interruttore differenziale di 30 mA ed un dispositivo di protezione contro le sovracorrenti adeguato alle caratteristiche della linea di collegamento.
- Antecedentemente al primo utilizzo, verificare che la tensione di rete corrisponda effettivamente a quella riportata sull'apparecchio.
- Questo apparecchio di riscaldamento è un apparecchio di classe II (doppio isolamento elettrico).
- È vietato il collegamento alla terra.
- **L'allacciamento dei tre fili** deve essere effettuato in una scatola di collegamento elettrico conforme alle norme in vigore.
- **Se inutilizzato, occorre isolare il filo pilota.**

Alimentazione monofase 230 V~ 50 Hz .

- Filo blu/grigio: Neutro
- Filo marrone: Fase
- Filo nero: Filo pilota

MONTAGGIO FISSAGGI A PARETE

1. Prima di montare il radiatore a parete verificare che siano rispettate le distanze indicate nei disegni «PREPARAZIONE ALL'INSTALLAZIONE» (vedi pag.10).
2. Determina il modello del tuo radiatore dalla tabella e rispetta le altezze e le larghezze indicate per il montaggio delle staffe di montaggio. Per l'assistenza all'installazione, fare riferimento ai disegni 1 e 2 (vedere la pagina successiva).

| Potenza | H | L |
|----------------|----------|----------|
| 1000 W | 207 mm | 220 mm |
| 1500 W | 207 mm | 420 mm |
| 2000 W | 207 mm | 620 mm |

H = Altezza dei fori di fissaggio
L = Larghezza dei fori di fissaggio

3. Fissare le staffe al muro utilizzando viti (non fornite) adatte alla struttura della parete su cui è posizionato il radiatore.
4. Una volta fissato, chiudere il sistema di sicurezza con le viti come mostrato nel disegno 3 (vedi pagina successiva).

NOTA

Le viti e i tesselli non sono forniti

NOTA

Le viti e i tesselli non sono forniti



4 x V

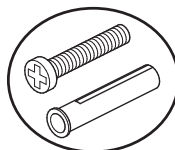

Usare la dima fornita

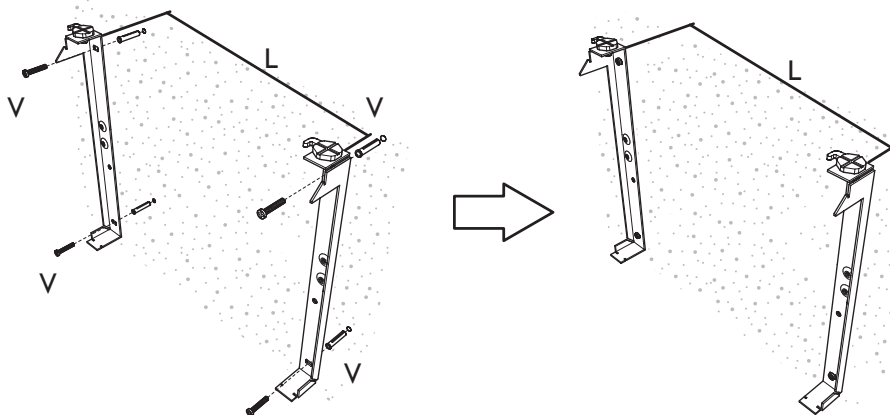
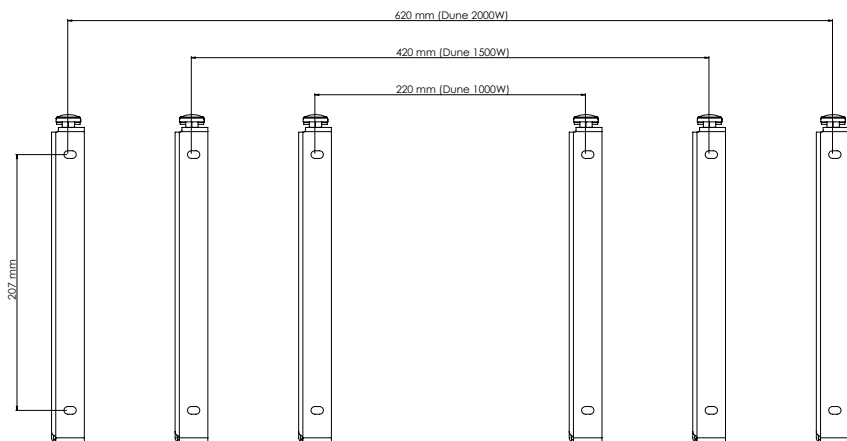

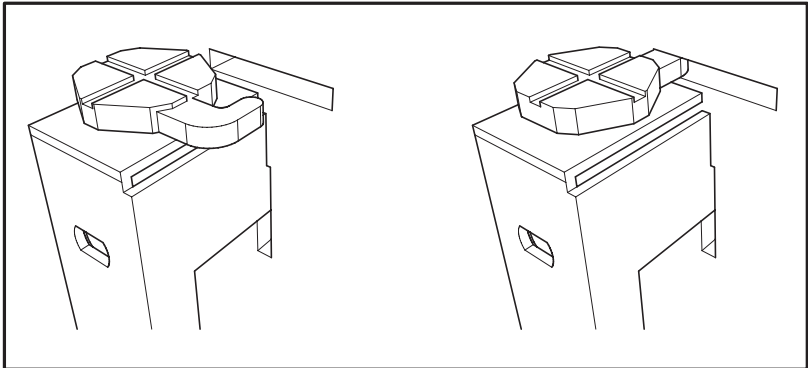
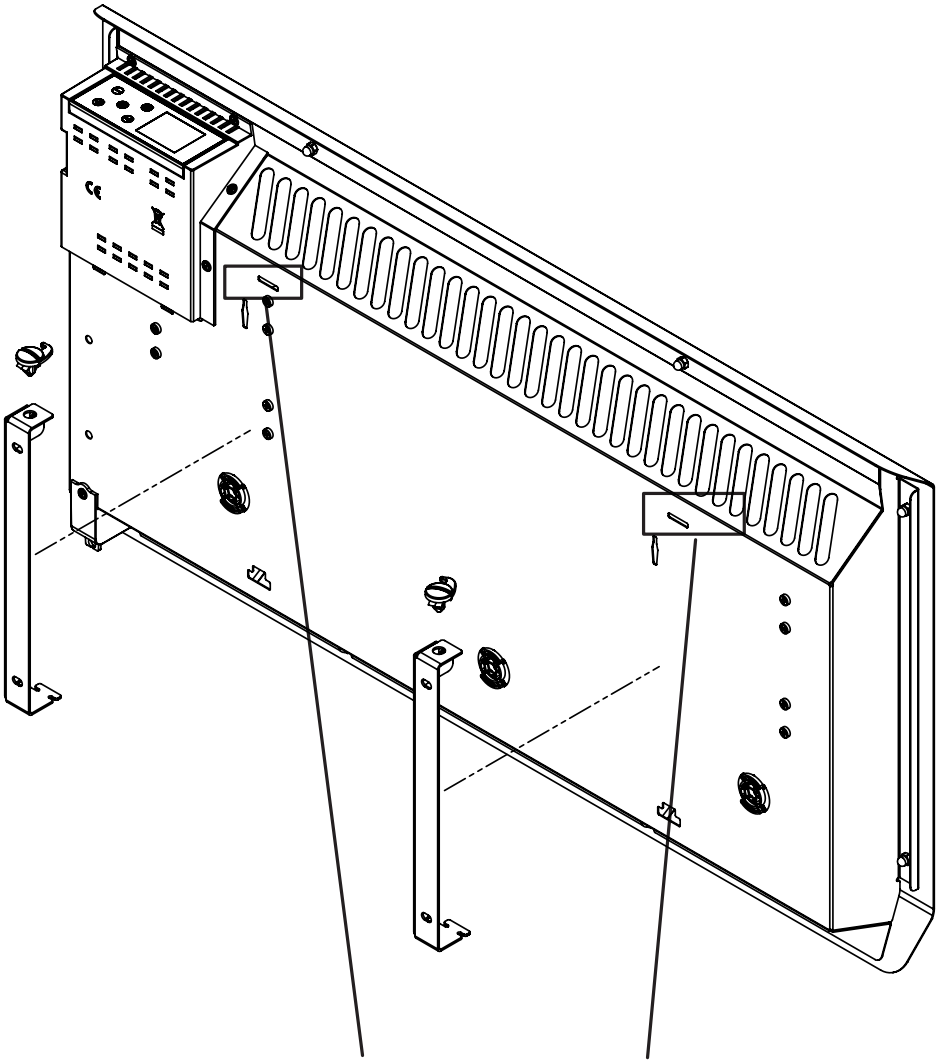

UTILIZZO CORRETTO

Utilizzare il prodotto come mostrato nella figura 1. Non mettere in nessun caso asciugamani o indumenti sul corpo esterno (figura 2). Un uso improprio può provocare pericolosi surriscaldamenti e compromettere il funzionamento del dispositivo.

Per pulire il dispositivo, non utilizzare prodotti chimici, ma un panno umido e non abrasivo.

1



2

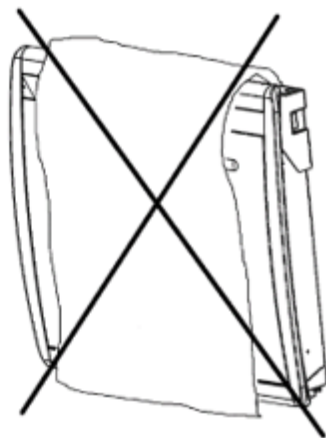

CARATTERISTICHE DELL'INTERFACCIA UTENTE

Display

Il display dispone di retroilluminazione.

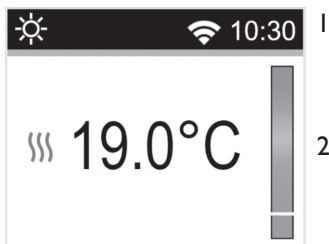





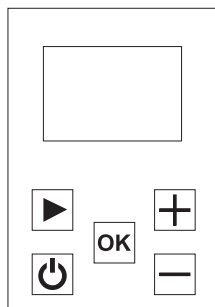

1 - Informazioni su modalità operativa/menù del termostato, ora e connessione WiFi.

2 - Informazioni su:

- modalità operativa del termostato: impostazione temperatura, indicatore di comportamento, temperatura misurata, indicatore di riscaldamento del radiatore;
- configurazione dei parametri: indicazione del valore effettivo dei parametri;
- selezione del programma per la modalità AUTO;

La tastiera comprende 5 tasti:



| | |
|---|--|
|  | Tasto ON/OFF (Riscaldamento acceso / spento) |
|  | Tasto meno |
|  | Tasto di validazione |
|  | Tasto più |
|  | Tasto di navigazione |

PRIMA ACCENSIONE E INSTALLAZIONE

Quando si accende il termostato o dopo aver ripristinato il prodotto, viene visualizzata questa prima schermata.

Il numero corrisponde alla versione del software del prodotto. La seconda schermata varia in funzione dello stato del termostato:

Alla prima accensione del prodotto, l'utente potrà configurare direttamente la connessione WiFi, la data e l'ora.

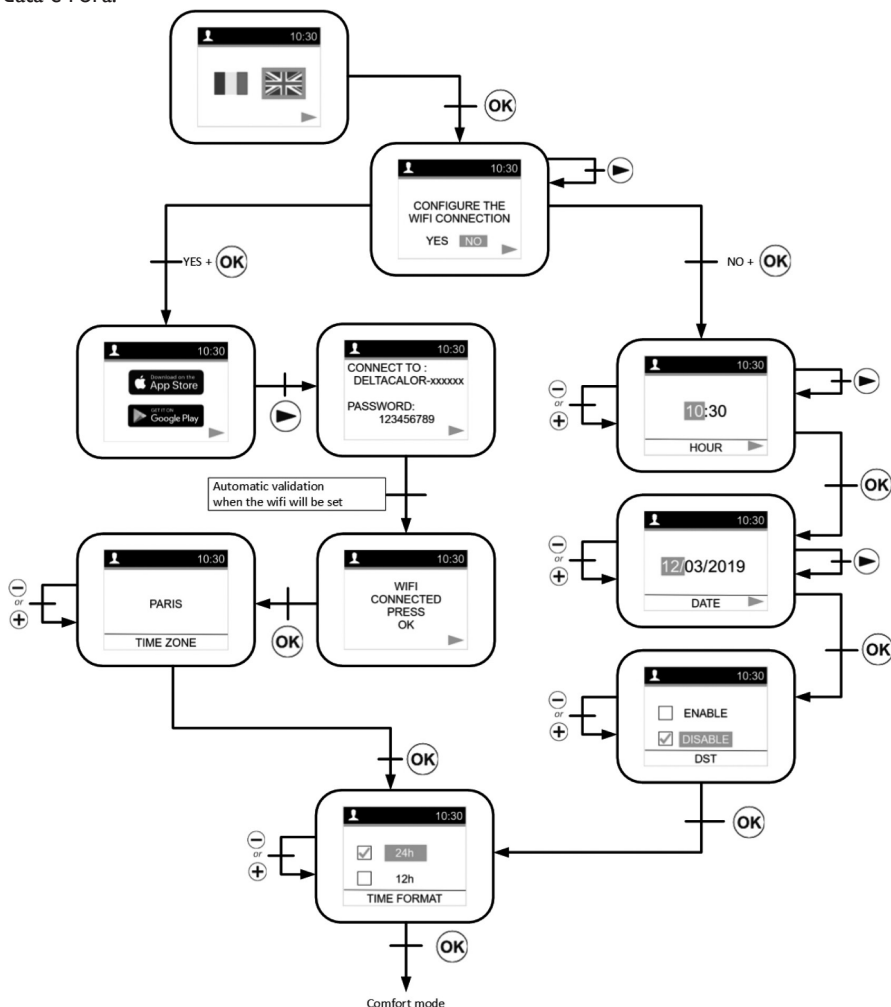

Andare a pagina 94 per configurare un radiatore e associarlo alla propria rete WiFi usando l'applicazione "DELTACALOR CONFORT".

A seguito di un'interruzione di corrente, comparirà la schermata della modalità attiva.

Dopo un ripristino del prodotto o un'interruzione di corrente prolungata nel tempo, verrà visualizzata la schermata di modifica dell'ora.

MENU DI SELEZIONE DELLA MODALITÀ

Per modificare la modalità attiva del termostato, premere il pulsante di navigazione destro ► per accedere alla selezione del menu.

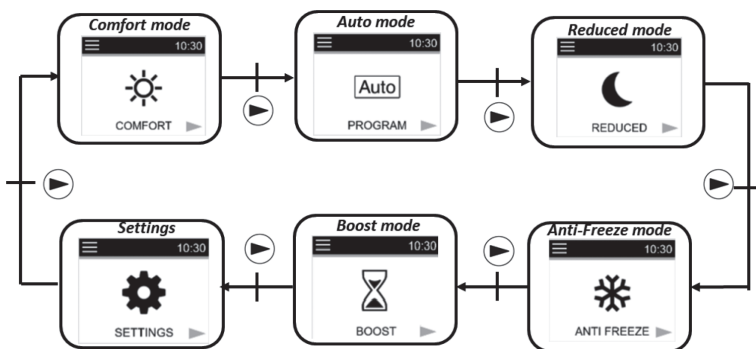

Spostare il cursore per scegliere una modalità operativa. Per selezionare una modalità, premere **OK**.

Confermare la modalità scelta premendo il pulsante **OK** altrimenti il termostato torna automaticamente all'ultima modalità selezionata **☰**, **☒**, **⏪**, o **Auto**.

Premendo **⏻**, è possibile accedere direttamente alla modalità di avvio/arresto riscaldamento:







Se non si preme alcun tasto per 5-10 secondi, verrà visualizzato uno screen saver. Questo screen saver potrebbe mostrare il valore della temperatura misurata o nulla:



Definizione delle modalità operative

Modalità Comfort

In questa modalità, verrà sempre seguita la temperatura comfort impostata. Sullo screen saver (retroilluminazione attiva), premendo il pulsante  o , la temperatura della configurazione comfort inizia a lampeggiare ed è possibile modificarla. Premendo il tasto  o attendendo 15 secondi senza fare alcun intervento, il valore impostato viene confermato. Tale impostazione sarà utilizzata in modalità **Auto** durante la fase alta del programma selezionato. . Dallo screen saver

(retroilluminazione attiva), premendo  è possibile passare dalla visualizzazione della temperatura misurata a quella impostata

Premendo il pulsante , viene visualizzato il menu di navigazione.

Premendo il pulsante , si disattiva il termostato.

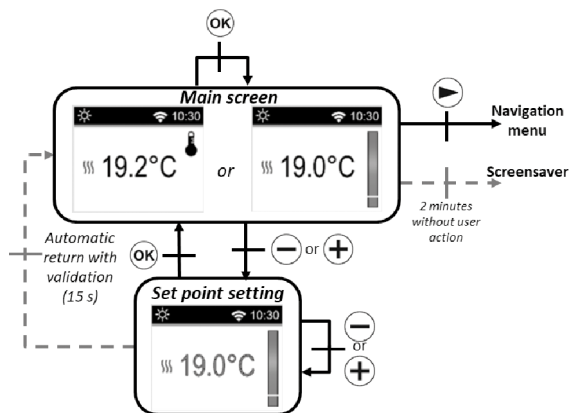

Valore predefinito: 19 °C.

Intervallo: da 10 a 30 °C (il valore massimo è modificabile nel menu dei parametri).





Modalità Eco

In questa modalità, il prodotto funziona a una temperatura ridotta configurata.

Dallo screen saver (retroilluminazione attiva), premendo il pulsante  o , la temperatura di configurazione ridotta inizia a lampeggiare ed è possibile modificarla.

Premendo il pulsante  o attendendo 15 secondi senza fare alcun intervento, il valore impostato viene confermato.

Tale impostazione sarà utilizzata in modalità **Auto** durante la fase alta del programma selezionato .

Dallo screen saver (retroilluminazione attiva), il pulsante  permette di passare dalla visualizzazione della temperatura misurata a quella configurata

Premendo il pulsante , viene visualizzato il menu di navigazione.

Premendo il pulsante , il termostato viene disattivato.

Valore predefinito: 17°C.

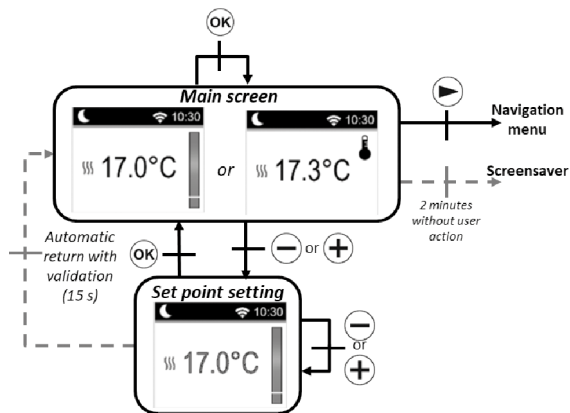

Intervallo: da 5,0 a 19 °C (o valore impostato inferiore a 0,5°C se inferiore).



Modalità automatica

In questa modalità, il termostato seguirà il programma scelto (da P1 a P9 integrati o da U1 a U2 personalizzati) in base all'ora e alla temperatura di configurazione Comfort e ridotta .

Nella schermata principale, il pulsante  permette di passare dalla visualizzazione della temperatura misurata a quella della temperatura di configurazione.

Premendo i pulsanti  e , è possibile ignorare, fino alla fase successiva del programma e per 2 ore, la temperatura del programma in uso modificandone il valore. Il valore inizia a lampeggiare e può essere modificato.

Premendo il pulsante  attendendo 15 secondi senza fare alcun intervento, il valore impostato viene confermato. Il simbolo della mano viene visualizzato quando la funzione

di superamento è attiva. Questo superamento continua fino alla fase successiva (il programma passa a un altro valore di temperatura) o per un massimo di 2 ore.



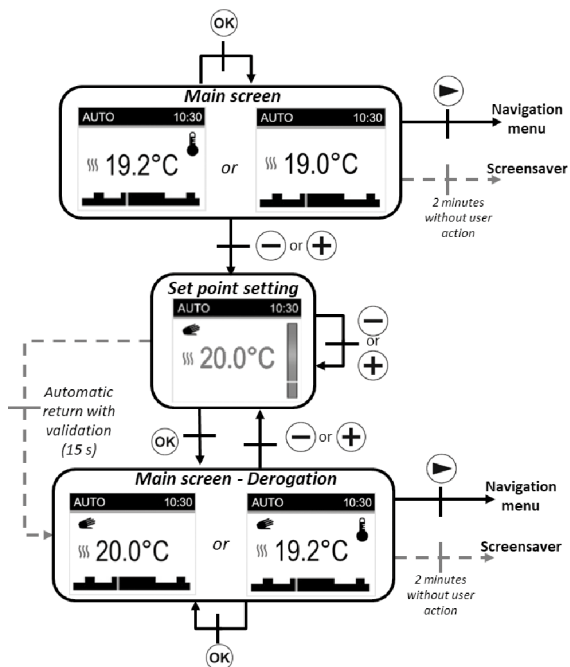

Premendo il pulsante , viene visualizzato il menu di navigazione.

Premendo il pulsante , il termostato si spegne.



Modalità antigelo

In questa modalità, verrà sempre seguito il valore della temperatura impostata per la protezione antigelo.

Nella schermata principale, premendo i pulsanti  e , il valore impostato della temperatura per la protezione antigelo inizia a lampeggiare e può essere modificato. Premendo il pulsante  o attendendo 15 secondi senza fare alcun intervento, il valore impostato viene confermato. Sul salvaschermo (retroilluminazione attiva),  consente di passare dalla visualizzazione della temperatura misurata alla

configurazione della temperatura premendo il pulsante , viene visualizzato il menu di navigazione.

Premendo il pulsante , il termostato si spegne.



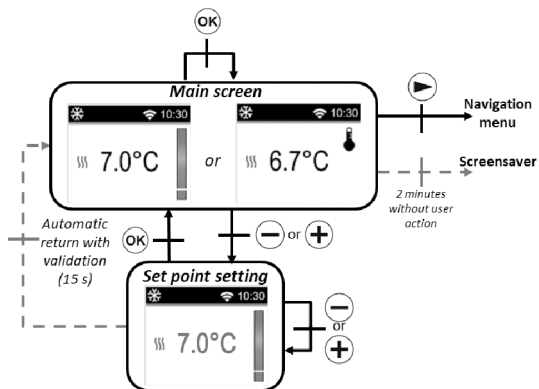

Valore predefinito: 7 °C

Intervallo: da 0,5 a 10 °C.



Modalità Riscaldamento spento

In modalità Riscaldamento spento, il simbolo viene visualizzato in modalità OFF .

Dopo aver premuto uno dei 4 pulsanti ( o  o  o ) , viene visualizzata la temperatura misurata.

Dopo alcuni secondi, tale informazione non viene più visualizzata.

Questa modalità applica una temperatura di riferimento pari a zero.

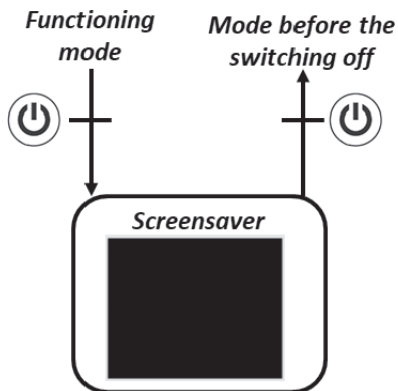

Premendo sul pulsante , il termostato si riattiva nell'ultima modalità selezionata..



Modalità Boost

Questa modalità consente di aumentare il riscaldamento con la temperatura massima impostata per un intervallo di tempo preconfigurato.

Impostazione dell'intervallo temporale:

Il valore temporale viene impostato utilizzando i pulsanti  e . Il pulsante convalida il valore temporale e il periodo di aumento rapido.

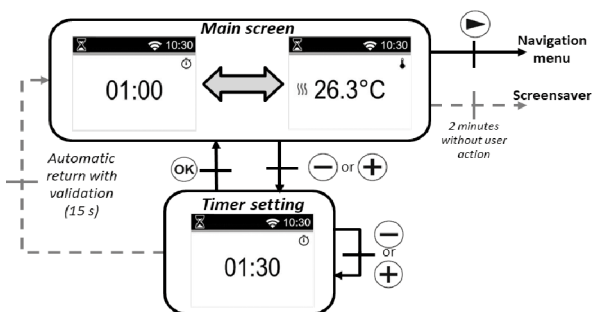

Valore predefinito: 1 ora

Intervallo di valori: 30 minuti, da 1H a 24 H, intervalli di 1 ora.

Con la modalità boost attiva, vengono visualizzati il tempo rimanente e la temperatura misurata.

Premendo  o  è possibile modificare le impostazioni.

Premendo il tasto  per un secondo si accede al menu di selezione della modalità.

Premendo il tasto  si spegne il prodotto e si ripristina il timer.

Definizione del menu “CONFIGURAZIONE”

Accedendo al menu “CONFIGURAZIONE”, è possibile scegliere tra diversi gruppi di parametri o azioni:

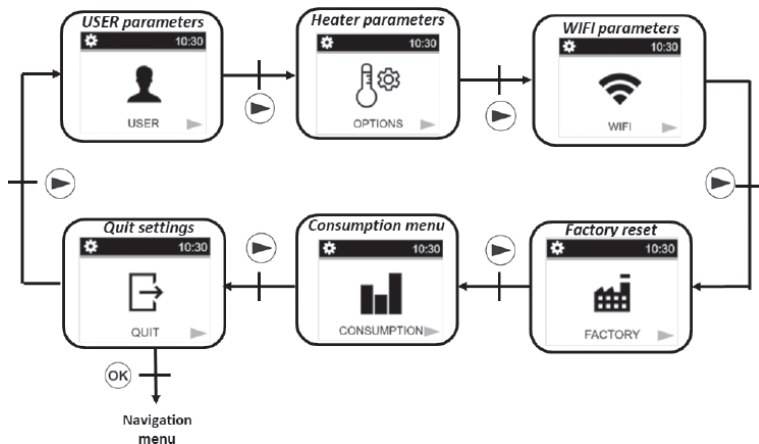

Per selezionare un menu, premere il pulsante . È possibile muoversi all'interno del menu utilizzando il pulsante . Per uscire dal menu dei parametri, selezionare la voce “ESCI” e premere il pulsante .

Un altro modo per uscire dal menu dei parametri è tenere premuto il pulsante per alcuni secondi.

Impostazioni utente

Il menu di configurazione dei parametri si seleziona premendo il pulsante .

La configurazione è possibile premendo il pulsante . Per uscire dal menu dei parametri, selezionare la voce “ESCI” e premere il pulsante .

Un altro modo per uscire dal menu dei parametri è tenere premuto il pulsante per alcuni secondi.



| | |
|---|---|
|  | Unità di misura dei gradi «UNITÀ» Valore predefinito: °C (Celsius) Altra scelta: °F (Fahrenheit) |
|---|---|

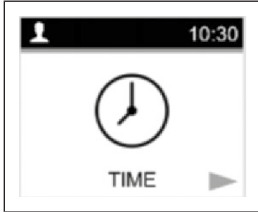

Menu «DATA E ORA» per configurare l'ora e la data

Esistono due modi per configurare l'ora e la data del termostato in base allo stato del WiFi (attivo o meno):

PRIMO METODO: WIFI DISATTIVATO

Modifica dell'ora:

Selezionare l'ora e i minuti con il pulsante **▶**
 Modificare i valori utilizzando i pulsanti **–** e **+**.
 Confermare le impostazioni con il pulsante **OK**.

Formato dell'ora:

Selezionare il formato 24H o AM/PM utilizzando i pulsanti **–** e **+**. Confermare le impostazioni con il pulsante **OK**.

Cambio automatico dell'ora:

Selezionare se far avvenire in modo automatico il cambiamento dell'ora (ora legale) usando i pulsanti **–** e **+**. Confermare le impostazioni con il pulsante **OK**.

Modifica della data:

Selezionare il giorno o il mese o l'anno con il pulsante **▶**. Modificare i valori utilizzando i pulsanti **–** e **+**. Confermare le impostazioni con il pulsante **OK**.

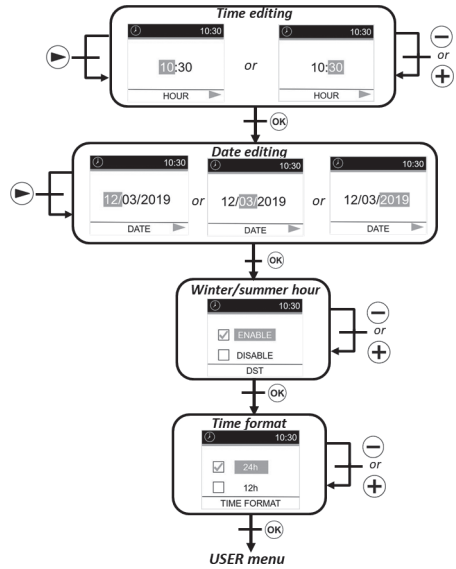

SECONDO METODO: WIFI ATTIVO

Fuso orario:

Selezionare il fuso orario locale utilizzando i pulsanti **–** e **+**.
 Confermare l'impostazione con il pulsante **OK**.

Formato dell'ora:

Selezionare il formato 24H o AM/PM utilizzando i pulsanti **–** e **+**. Confermare l'impostazione con il pulsante **OK**.

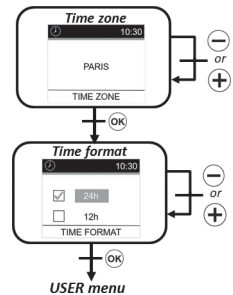

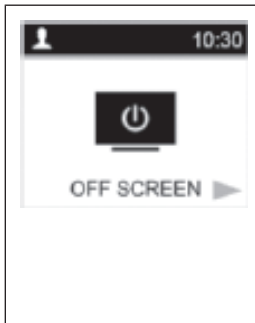

SCHERMO VIDEO OFF

Quando nessuna modalità è attiva, lo schermo appare come di seguito:

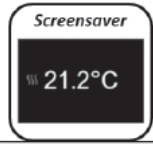

Valore predefinito: nessuno

Altra scelta: Temperatura misurata (7h00 à 23h00)

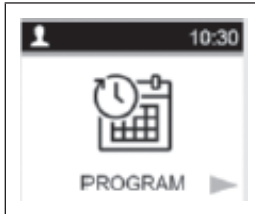

Programma

questo menu permette di selezionare la programmazione da applicare in modalità auto AUTO.

Programma:

Selezionare “Selezione” con il pulsante . Confermare l'impostazione utilizzando il pulsante .

Selezione:

Selezionare il numero del programma con il pulsante . Selezionare il giorno con i pulsanti e .

Confermare il numero del programma con il pulsante .

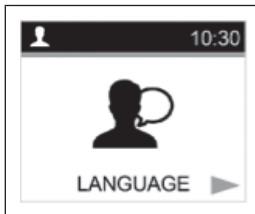
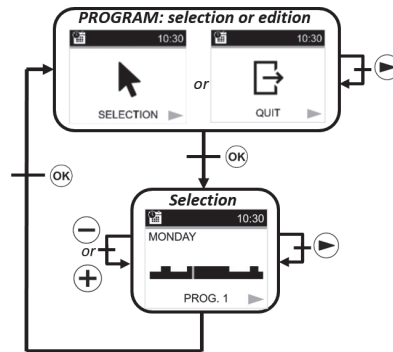

Selezione della lingua

Valore predefinito: Inglese

Altra scelta: Francese, Italiano, Tedesco e Spagnolo

| | |
|---|--|
|  | <p>Uscire dal menu impostazioni Se premete il tasto OK potete uscire dal menu impostazioni UTENTE e tornare al menu IMPOSTAZIONI.</p> |
|---|--|

Opzioni e impostazioni del radiatore

Il menu di configurazione dei parametri si seleziona premendo il pulsante **▶**. La configurazione è possibile premendo il pulsante **OK**.

Per uscire dal menu dei parametri, selezionare la voce "ESCI" e premere il pulsante **OK**. Un altro modo per uscire dal menu dei parametri è tenere premuto il pulsante **▶** per alcuni secondi.

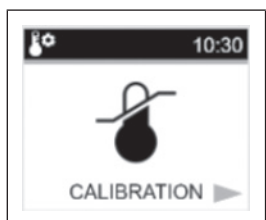
| | |
|---|--|
|  | <p>Calibrazione del sensore di temperatura: Eseguire la calibrazione dopo 1 giorno di utilizzo con la stessa temperatura di impostazione, come descritto di seguito:</p> |
|---|--|



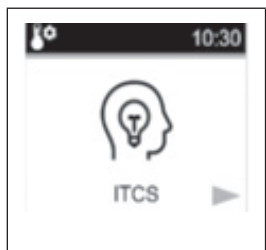

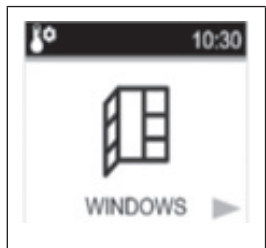
1. Posizionare un termometro nella stanza, a una distanza dal pavimento pari a quella del termostato. Controllare la temperatura effettiva nella stanza dopo 1 ora.
2. Immettere questo valore nel menu dei parametri di calibrazione utilizzando i pulsanti **-** e **+** per immettere il valore effettivo.
3. Premere **OK** per confermare la calibrazione

| | |
|--|---|
|  | <p>ITCS - Intelligent Temperature Control System (riscaldamento con avvio adattivo in modalità AUTO) Questa funzione è descritta nel paragrafo "Funzioni speciali". Questa impostazione permette di attivare o meno questa funzione.</p> <p>Valore predefinito: Sì (attivazione della funzione) Altre opzioni: No</p> |
|--|---|



| | |
|---|---|
|  | <p>Rilevamento automatico finestra aperta Questa funzione è descritta nel paragrafo "Funzioni speciali". Questa impostazione permette di attivare o disattivare questa funzione.</p> <p>Valore predefinito: Sì (attivazione della funzione) Altre opzioni: No</p> |
|---|---|

| | |
|---|---|
|  | <p>Potenza di riscaldamento</p> <p>Questo parametro corrisponde alla potenza del riscaldatore. È necessario configurare tale parametro per calcolare il consumo energetico e selezionare i parametri di regolazione.</p> <p>Valore predefinito: 900 Altre opzioni: 1000, 1500, 1800, 2000</p> |
|  | <p>Limite di potenza</p> <p>Questo parametro consente di ridurre manualmente la potenza del radiatore.</p> <p>Valore predefinito: NO (100%) Altre opzioni: NO (100%)/75%/50%</p> |
|  | <p>Programmazione temperatura boost</p> <p>Valore di temperatura impostato con la modalità boost attiva.</p> <p>Valore predefinito: 30 °C Altre opzioni: da 20 a 30 °C</p> |
|  | <p>Limitazione della temperatura ambiente</p> <p>Limitazione della temperatura ambiente massima regolabile da remoto.</p> <p>Valore predefinito: 30 °C Altre opzioni: da 20 a 30 °C</p> |
|  | <p>Uscire dal menu parametri</p> <p>Premendo il pulsante  è possibile uscire dal menu parametri e tornare al normale funzionamento</p> |

Impostazioni WIFI

Il menu di configurazione dei parametri si seleziona premendo il pulsante . La configurazione è possibile premendo il pulsante . Per uscire dal menu dei parametri, selezionare la voce “ESCI” e premere il pulsante . Un altro modo per uscire dal menu dei parametri è tenere premuto il pulsante  per alcuni secondi.



| | |
|---|--|
|  | <p>INFORMAZIONI WIFI: Questo menu mostra le informazioni sul WIFI:</p> <ul style="list-style-type: none"> • Stato della connessione: CONNESSO, Modalità AD HOC, NON CONNESSO e CONNESSIONE; • SSID; • indirizzo IP; • indirizzo MAC. |
|  | <p>CONNESSIONE Abilita la connessione cloud del prodotto. Nota: il prodotto deve essere configurato in modalità ad hoc prima di attivare la connessione (v. di seguito).</p> |
|  | <p>AD HOC (modalità diretta): Attiva la modalità AD HOC, che consente di configurare la rete WIFI utilizzando l'applicazione. Quando il termostato funziona in questa modalità, è visibile un'antenna diversa sullo schermo</p>  |
|  | <p>WIFI OFF Disattivazione della connessione WIFI.</p> |
|  | <p>RIPRISTINO IMPOSTAZIONI WIFI eliminare tutte le connessioni WIFI configurate.</p> |

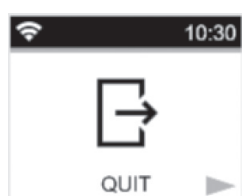

USCIRE DAL MENU
premere il tasto **OK** per uscire dal menu WIFI.

Ripristino delle impostazioni di fabbrica

Tutte le impostazioni del termostato verranno caricate con le impostazioni di fabbrica.

Premendo sul pulsante **OK**, il termostato ripristina le impostazioni.

Il termostato riporta alle configurazioni predefinite di fabbrica i seguenti valori:

- temperature nominali;
- impostazioni;
- ora;
- consumo energetico;
- impostazioni WIFI.



Menu di registrazione dei consumi

Questa modalità è disponibile solo se la potenza del radiatore è stata configurata dall'utente.

Premere **▶** per modificare l'intervallo di tempo per la visualizzazione del consumo energetico (ultime 24 ore, ultimi 7 giorni e durata 30 giorni).

Se non si preme alcun pulsante, il termostato tornerà automaticamente alla modalità precedentemente selezionata

Premere **OK** per tornare al menu CONFIGURAZIONI.

Premendo **-** o **+** per alcuni secondi si azzerano i valori del consumo energetico.

Un altro modo per uscire dal menu dei parametri è tenere premuto il pulsante **▶** per alcuni secondi. Premere **⏻** per spegnere il prodotto.

I valori stimati vengono salvati in memoria ogni 4 ore e ogni volta che l'utente visualizza questo menu.

Se lo **SPEGNIMENTO** è attivo, i valori vengono mantenuti per le 12 ore successive

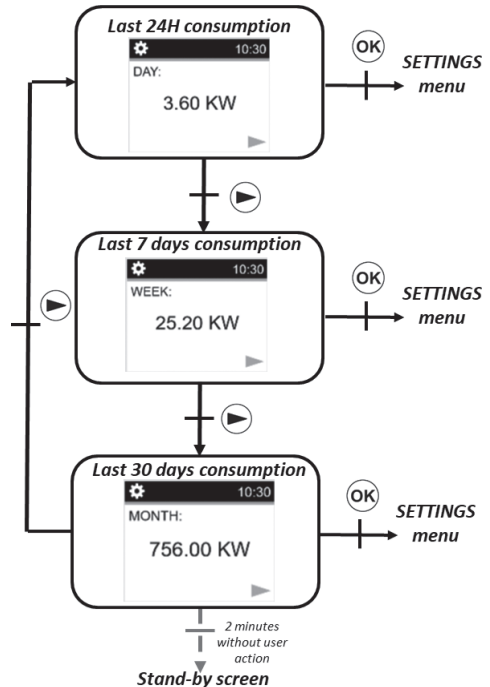

Descrizione del programma integrato

- P1: mattina (7h-9h), sera (17h-23h), e weekend (8h-23h)
- P2: mattina (7h-9h), mezzogiorno (12h-14h), sera (18h-23h) e weekend (8h-23h)
- P3: giorno (6h-23h), sabato (7h-24h) e domenica (notte (0h-1h), giorno (7h-23h))
- P4: sera (15h-23h) e sabato (7h-24h) e domenica (notte (0h-1h), giorno (7h-23h))
- P5: mattina (6h-8h), sera (21h-23h) e sabato (mattina 7h-9h), sera 18h-24h) e domenica (mattina (7h-9h), sera (18h-23h))
- P6: mattina (6h-8h), mezzogiorno (14h-21h) e weekend (7h-21h)
- P7: ufficio dal lunedì al venerdì (7h-19h) e weekend (spento)
- P8: Magazzino: dal lunedì al venerdì (8h - 19h) e sabato (8h -18h) e domenica (spento)
- P9: Seconda casa: da venerdì (13h) a lunedì (7h)

Salvare le configurazioni

Questo termostato salva automaticamente i dati (valori impostati, programma utente e configurazioni) quando:

1. L'utente convalida le modifiche apportate alle configurazioni premendo il tasto di convalida.
2. La retroilluminazione del prodotto si spegne.

Memorizza inoltre i valori stimati del consumo energetico:

1. Ogni 4 ore
2. Quando l'utente entra in modalità di consumo.

Funzioni speciali

ITCS: Sistema intelligente di controllo della temperatura

Questa funzione può essere attivata tramite la voce "ITCS" nel menu Parametri (v. il capitolo "menu Parametri").

Consente di attivare l'impianto in anticipo (2 ore al massimo) quando il termostato è in modalità Auto. Inoltre, garantisce la temperatura desiderata all'orario programmato secondo il programma settimanale.

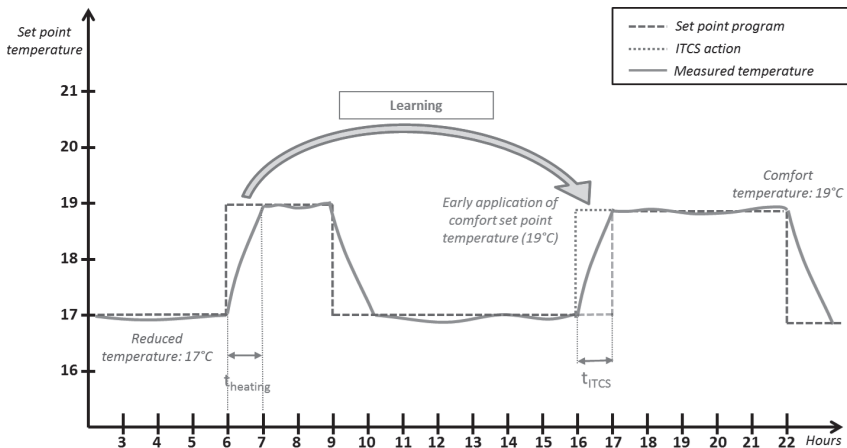

Per funzionare, il sistema ITCS esegue automaticamente diverse misurazioni di temperatura in vari momenti. L'obiettivo è stimare una velocità di riscaldamento dell'impianto. Con questo valore, il sistema può calcolare in anticipo il momento in cui attivare il riscaldamento. Quando il termostato viene acceso per la prima volta, viene utilizzato un periodo di tempo predefinito per raggiungere la temperatura impostata. Tale valore verrà regolato da nuove misurazioni a ogni cambio di programma per compensare le variazioni della temperatura esterna. Quindi, è possibile programmare il termostato senza regolazione perché avverrà in modo automatico. Se il sistema esegue un avvio adattivo, sullo schermo viene visualizzato l'icona della mano.

Rilevamento finestra aperta

Questa funzione può essere attivata alla voce "finestra" nel menu dei parametri. Viene eseguita misurando e registrando la variazione di temperatura negli ultimi 20 minuti:

- Primo passo con rilevamento finestra aperta attivo: il termostato passa allo stato "Finestra aperta"  (e il valore della temperatura lampeggia) quando la temperatura scende negli ultimi 20 minuti di oltre 1,5 °C, con il prodotto acceso e in fase di riscaldamento.
- Secondo passo: se la temperatura supera 0,3 °C in 20 minuti, lo stato di finestra aperta viene rimosso e il termostato torna automaticamente al valore della modalità in uso.

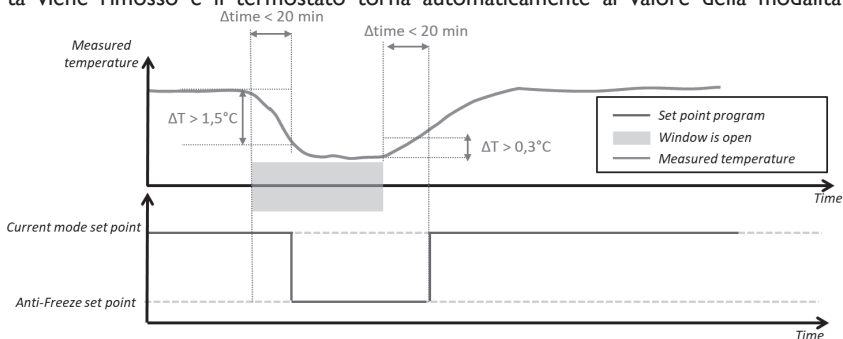
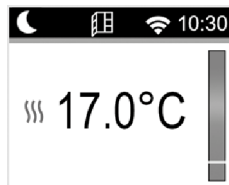

Salvataggio dei dati in caso di interruzione di corrente prolungata

Questo prodotto può continuare a conteggiare lo scorrere del tempo per 12 ore dopo un'interruzione di corrente.

Se l'interruzione di corrente dura troppo a lungo, l'ora e la data verranno ripristinate ai valori predefiniti di fabbrica. Sarà quindi necessario riconfigurare tali valori.

Blocco tastiera

Per attivare questa funzione è necessario premere contemporaneamente i pulsanti \ominus o \oplus per 5 secondi. Tutti i pulsanti sono bloccati eccetto Avvio/arresto riscaldamento \odot .

Questa funzione è accessibile in qualsiasi modalità. Sullo schermo viene visualizzata l'icona \mathfrak{L} per sbloccare la tastiera, è necessario ripetere la stessa procedura. **NOTA:** in caso di mancanza di alimentazione la configurazione viene mantenuta.



Modalità controllo filo pilota

| Comando filo pilota | Schermata | Comando filo pilota | Schermata |
|---------------------|-----------|---------------------|-----------|
| Comfort | | ECO | |
| Comfort-1° | | Antigelo | |
| Comfort -2° | | Stand-by | |

Priorità negli ordini dei cavi pilota

| Modalità impostata su termostato | Comando dal filo pilota | Modalità effettiva impostata |
|----------------------------------|-------------------------|--|
| Modalità AUTO (comfort) | Comfort | Comfort |
| | Comfort -1°C | Comfort -1°C |
| | Comfort -2°C | Comfort -2°C |
| | Comfort -3.5°C / eco | Valore inferiore tra Comfort -3.5°C e 19°C |
| | Antigelo | Antigelo |
| | Stop | Stop |
| Modalità AUTO (eco) | Comfort | Temperatura impostata in modalità ECO |
| | Comfort -1°C | |
| | Comfort -2°C | |
| | Comfort -3.5°C / eco | Valore inferiore tra la temperatura impostata in modalità ECO e "Comfort -3.5°C" |
| | Antigelo | Antigelo |
| | Stop | Stop |
| Modalità AUTO (manuale) | Comfort | Temperatura impostata manualmente |
| | Comfort -1°C | |
| | Comfort -2°C | |
| | Comfort -3.5°C / eco | |
| | Antigelo | |
| | Stop | |

Se il rilevamento finestra aperta  è attivo, e se questa funzione rileva l'apertura, il termostato segue le regole presentate nel paragrafo "Rilevamento finestra aperta". Il termostato mostra il valore della temperatura impostato applicato al riscaldatore. Prende in considerazione l'ordine di priorità presentato sopra.

Descrizione degli errori

Se il sensore è spento o scollegato, sullo schermo del termostato apparirà un messaggio di errore.

| | | |
|------------------------------|---|---|
| Problema del sensore |  | il messaggio «-» è accompagnato dall'icona lampeggiante e dal logo sul display. |
| Problema di connessione WIFI |  | Il logo WIFI è rosso |

APPLICAZIONE PER DISPOSITIVI MOBILI (SMARTPHONE)

Indicazioni generali

L'applicazione è disponibile solo per piattaforme IOS e Android



L'applicazione consente di configurare il WIFI e controllare a distanza il radiatore. Per prima cosa, scaricare l'applicazione gratuita "DELTACALOR CONFORT"



sul proprio dispositivo mobile cellulare (smartphone).

Grazie all'app, è possibile aggiungere un dispositivo all'app e configurare la rete WIFI.

1. Fare clic su "elenco dei miei impianti" per visualizzare l'impianto esistente o aggiungerne uno nuovo.

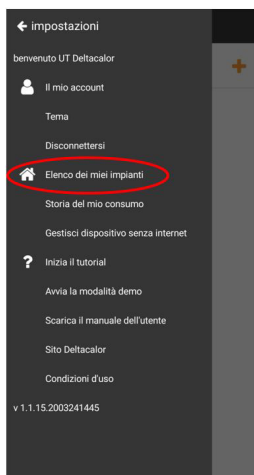

2. Fare clic sul segno "più" per aggiungere un nuovo dispositivo.

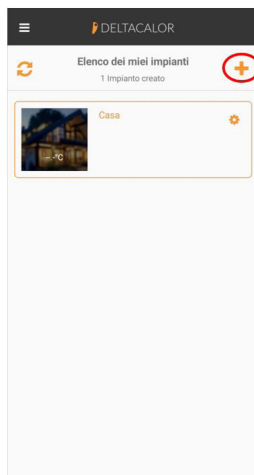

3. Attendere la connessione WIFI.

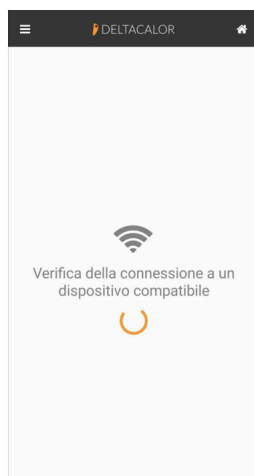

4. Se lo smartphone non è connesso al prodotto, accedere alle configurazioni WIFI del telefono cliccando su Configurazione WIFI. Quindi tornare all'applicazione.

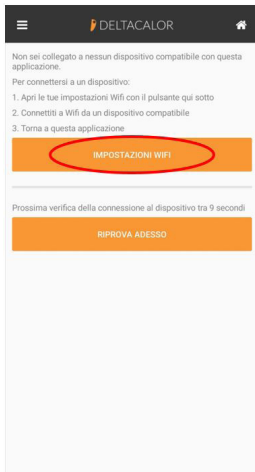

5. Creare l'impianto, il nuovo prodotto e aggiungere il nome del dispositivo.

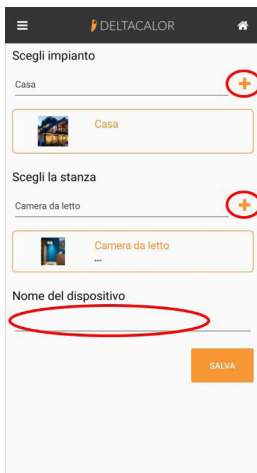

6. Salvare la configurazione

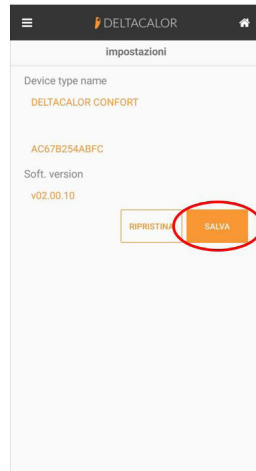

7. Collegare il prodotto a Internet, scegliere la rete e inserire la password.

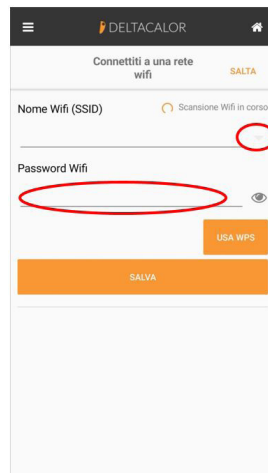

8. Premere il tasto fino al completamento della configurazione della rete del dispositivo.

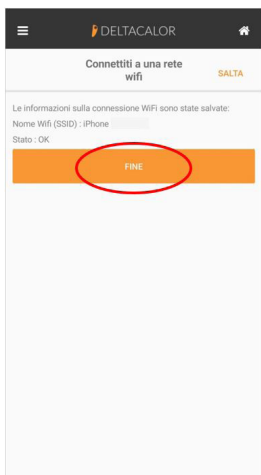

- È possibile scegliere tra modalità Eco, Protezione antigelo o Auto con una riduzione imposta dal gestore energia. Passare alla modalità Comfort permanente o aumentare il valore impostato.
- Verificare che il dispositivo non sia in prossimità di una presa d'aria.
- Verificare che la temperatura impostata non sia stata modificata

COSA FARE IN CASO DI PROBLEMI

Il dispositivo non riscalda abbastanza

- Puoi essere in modalità Eco, Freeze. Passare alla modalità Comfort permanente o aumentare la temperatura impostata.

Il dispositivo si riscalda continuamente.

- Verificare che il dispositivo non sia installato di fianco ad una corrente d'aria.
- Verificare che la temperatura impostata non sia stata modificata.

Se il problema persiste interrompere l'alimentazione elettrica al radiatore e attendere almeno un minuto prima di ripristinarla.

Nel caso in cui il problema continui a presentarsi, si prega di contattare l'assistenza tecnica.

VIDEO TUTORIAL



Per collegare il termostato WI-FI Segui le istruzioni nel manuale o guarda il video tutorial inquadrando il codice QR qui a lato, con il tuo smartphone

CARATTERISTICHE TECNICHE

| | | |
|------------------------------|--|---|
| Prodotto | Radiatore elettrico | |
| Applicazione | Uso domestico | |
| Classe d'isolamento | CLASSE II | |
| Classe IP | IP24 | |
| Colore plastica | Bianco | |
| Colore cavo di alimentazione | Bianco | |
| Selezione della temperatura | Numerico | |
| Modalità di regolazione | Numerico con 5 bottoni | |
| Modalità di funzionamento | Comfort, Notte, Antigelo , ECO, Chrono, Vacanza, Rilevamento finestra aperta, Protezione bambini, Controllo di avviamento adattivo, Blocco tasti | |
| Range di temperatura | 0.5 + 30°C | |
| Potenza massima | 2000W | |
| Banda di frequenza | 2400MHz to 2484MHz | |
| Tensione di alimentazione | 230Vac 50Hz | |
| Connessioni elettriche | 3 cavi: neutro (grigio), fase (marrone), Filo-Pilota (Nero) | |
| Garanzia | 2 anni | |
| Standard | EN 60335-1 EN 61000-3-2 EN 62233 EN 55014-1 NFC 15-100 | EN 60335-2-30 EN61 000-3-3 EN 55014-2 |

Produttore: DELTACALOR s.r.l

Manuale di istruzione disponibile sul sito:

<https://www.deltacalor.com/customer-care/downloads/>

Il simbolo  apposto sul prodotto, segnala l'obbligo di consegnare l'apparecchio da smaltire presso un punto di raccolta specializzato, conformemente alla Direttiva 2012/19/UE. In caso di sostituzione, l'apparecchio può anche essere restituito al rivenditore. Questo prodotto non rientra nella categoria dei rifiuti domestici ordinari. Una corretta gestione del suo smaltimento consente di salvaguardare l'ambiente e di limitare lo sfruttamento delle risorse naturali.

Dichiarazione di conformità: Il fabbricante dichiara, sotto la propria esclusiva responsabilità, che il prodotto oggetto del presente manuale soddisfa i requisiti essenziali delle Direttive LVD 2014/35/UE, CEM 2014/30/UE e RoHS 2011/65/UE.



Riferimento (i) modello: DUNE

| modalità 1000 W | | | |
|-------------------------------------|-------------|---------|-------|
| Caratteristiche | Simbolo | Valore | Unità |
| Potenza termica | | | |
| Potenza termica nominale | P_{nom} | 1.0 | kW |
| Potenza termica minima (indicativa) | P_{min} | n.d. | kW |
| Potenza termica massima continua | $P_{max,c}$ | 1.0 | kW |
| Consumo ausiliario di elettricità | | | |
| Alla potenza termica nominale | el_{max} | 1.0 | kW |
| Alla potenza termica minima | el_{min} | n.d. | kW |
| In modalità risparmio | el_{SB} | <0,0005 | kW |

| modalità 1500 W | | | |
|-------------------------------------|-------------|---------|-------|
| Caratteristiche | Simbolo | Valore | Unità |
| Potenza termica | | | |
| Potenza termica nominale | P_{nom} | 1.5 | kW |
| Potenza termica minima (indicativa) | P_{min} | n.d. | kW |
| Potenza termica massima continua | $P_{max,c}$ | 1.5 | kW |
| Consumo ausiliario di elettricità | | | |
| Alla potenza termica nominale | el_{max} | 1.5 | kW |
| Alla potenza termica minima | el_{min} | n.d. | kW |
| In modalità risparmio | el_{SB} | <0,0005 | kW |

| modalità 2000 W | | | |
|-------------------------------------|-------------|---------|-------|
| Caratteristiche | Simbolo | Valore | Unità |
| Potenza termica | | | |
| Potenza termica nominale | P_{nom} | 2.0 | kW |
| Potenza termica minima (indicativa) | P_{min} | n.d. | kW |
| Potenza termica massima continua | $P_{max,c}$ | 2.0 | kW |
| Consumo ausiliario di elettricità | | | |
| Alla potenza termica nominale | el_{max} | 2.0 | kW |
| Alla potenza termica minima | el_{min} | n.d. | kW |
| In modalità risparmio | el_{SB} | <0,0005 | kW |

Dettagli del contatto: **Deltacalor S.r.L** - Via Mazzini, 23801 Calolziocorte (LC) - ITALIA



REGLAS DE SEGURIDAD



- En caso de daños que deriven del no respeto de estas reglas no se podrá aplicar la garantía del fabricante.
- No utilicen el aparato en el exterior.
- Su aparato está destinado para uso doméstico y no debe emplearse para otras finalidades.
- Si el aparato se ha caído, se ha estropeado o no funciona correctamente, no lo ponga en marcha y asegúrese de que la alimentación del mismo no esté conectada (fusible o interruptor).
- Nunca desarmen el aparato. Un aparato mal reparado puede implicar riesgos para quien lo utiliza. Para cualquier problema, consulten a su punto de venta.
- Si el cable de alimentación se ha estropeado, tiene que ser reemplazado por el fabricante, el servicio pos-venta o por otro profesional, para evitar cualquier tipo de peligro.
- Advertencia: cable de alimentación no debe tocar el elemento de calefacción.
- Advertencia: para evitar el riesgo de sobrecalentamiento, no cubrir el aparato. En caso contrario, el aumento de la temperatura activará el dispositivo de protección interno.
- El aparato de calefacción tiene que instalarse de manera que los interruptores y los otros dispositivos de mando no puedan ser tocados por una persona que se encuentre **en la bañera o en la ducha** (ref. norma NF C15-100).
- El circuito de alimentación de este aparato tiene que incluir un dispositivo de interrupción omnipolar (ref. norma NF C15-100)



No cubra el radiador



ADVERTENCIAS PARA LAS PERSONAS DISCAPACITADAS Y LOS NIÑOS



- Este aparato puede ser utilizado por personas con capacidades físicas, sensoriales y mentales reducidas o sin conocimiento acerca del producto, o bien por niños a partir de 8 años de edad, siempre que estén vigilados e instruidos sobre el uso seguro del aparato y conscientes de todos los riesgos.
- Los niños no deben jugar con el aparato.
- Las operaciones de limpieza y mantenimiento no deben ser realizadas por niños sin vigilancia.
- Se recomienda mantener fuera del alcance de los niños menores de 3 años, si no están bajo supervisión continua.
- Los niños de entre 3 y 8 años solo deben encender o apagar el aparato, con tal de que esté instalado en la posición normal prevista y los niños estén bajo la supervisión continua o hayan recibido instrucciones relativas al uso del aparato en seguridad y entiendan perfectamente los peligros potenciales.
- Los niños de entre 3 y 8 años no deben conectar, regular o limpiar el aparato, ni someterle a mantenimiento.

ATENCIÓN

Algunas partes del producto pueden sobrecalentarse y provocar quemaduras. Prestar especial atención en presencia de niños y personas vulnerables.



ADVERTENCIA PARA TERMOSTATO WIFI



El aparato permite el control a distancia mediante una conexión WI-FI.



Es obligatorio respetar una distancia mínima de al menos 20 cm desde la zona habitable para el hombre.





SEGURIDAD PARA NIÑOS

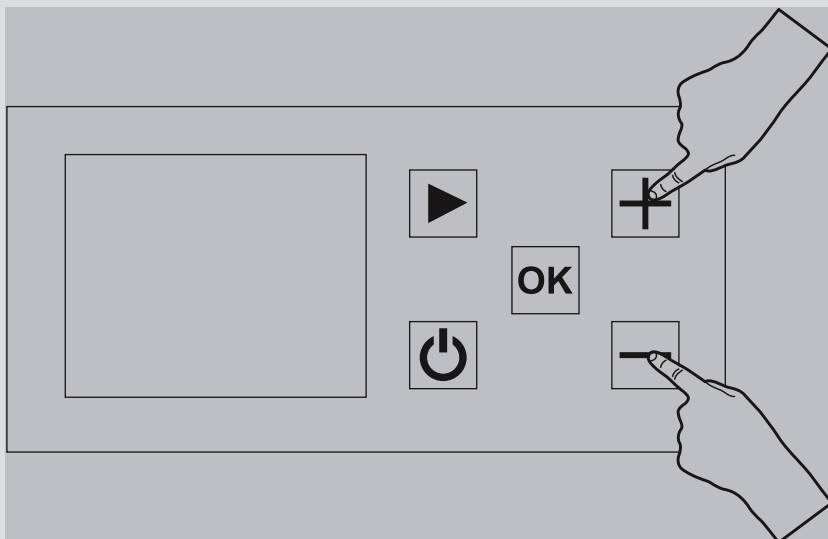

Bloqueo del teclado «»

En un modo de funcionamiento normal, presionar en forma simultánea las teclas  y  durante 5 segundos como mínimo



Todos los botones están bloqueados excepto el de la calefacción On/Off .

En esta modalidad no es posible cambiar la configuración del programa, la temperatura o activar otras funciones.

ALIMENTACIÓN Y CONEXIONES ELÉCTRICAS

- La alimentación del aparato de calefacción tiene que estar protegida, conforme a las normas vigentes, por un interruptor diferencial de 30 mA y por un dispositivo de protección contra la sobrecorriente adaptado a las características de la línea de conexión.
- Antes de utilizar el aparato por primera vez, verificar que la tensión utilizada corresponda a la indicada en el aparato.
- Este aparato de calefacción es un aparato de clase II (doble aislamiento eléctrico).
- La conexión a tierra está prohibida.
- **La conexión de los tres cables** tiene que ser realizada dentro de una caja de conexión eléctrica conforme a las normas vigentes.
- **Tienen que aislar el cable piloto si no lo utilizan.**

Alimentación monofásica 230 V~ 50 Hz.

- Cable azul/gris: neutro
- Cable marrón: fase
- Cable negro: cable piloto

FIJACIÓN DE LAS CONSOLAS A LA PARED

1. Antes del montaje del radiador en la pared, verificar que se respeten las distancias indicadas en los dibujos “PREPARACIÓN DE LA INSTALACIÓN” (véase p.6).
2. Determinar el modelo de radiador que se va a instalar en la tabla siguiente y respetar las alturas y el ancho indicados para la colocación de los soportes de montaje. Por ayuda sobre la instalación, consultar los dibujos 1 y 2 (véase la página siguiente)

| Potencias | H | L | Placas de fijación |
|-----------|--------|--------|--------------------|
| 1000 W | 207 mm | 220 mm | 3 |
| 1500 W | 207 mm | 420 mm | 3 |
| 2000 W | 207 mm | 620 mm | 3 |

H = Altura orificios de fijación
L = Ancho orificios de fijación

3. Fijar los soportes a la pared por medio de tacos (no provistos) adaptados a la estructura de la pared sobre la cual se va a colocar el radiador.
4. Cuando esté fijo, cerrar el sistema de seguridad con tornillos según lo indicado en el dibujo 3 (véase página siguiente).

NOTA

No se suministran tornillos ni fischers

NOTA

No se suministran tornillos ni fichers

2 ×



4 × V

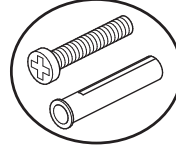

UTILIZAR LA PLANTILLA FACILITADA

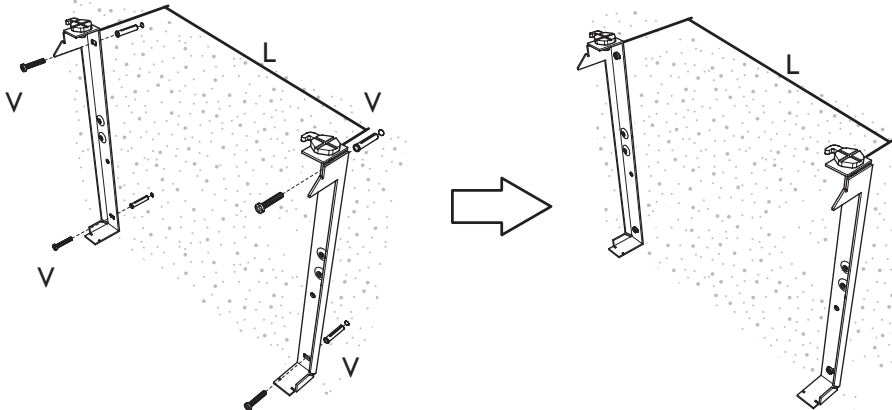
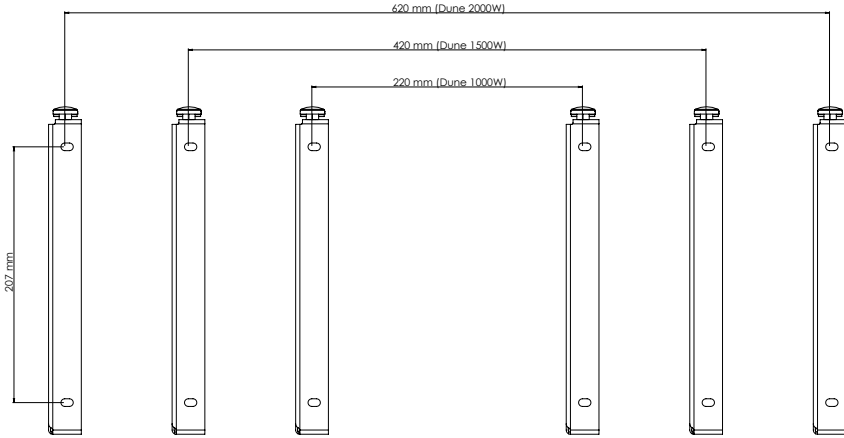

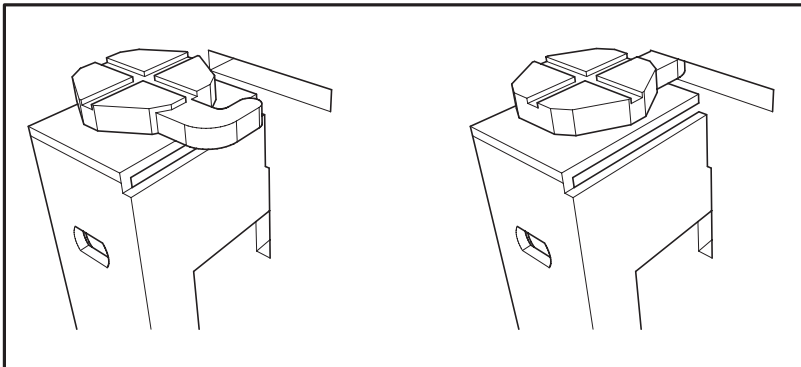
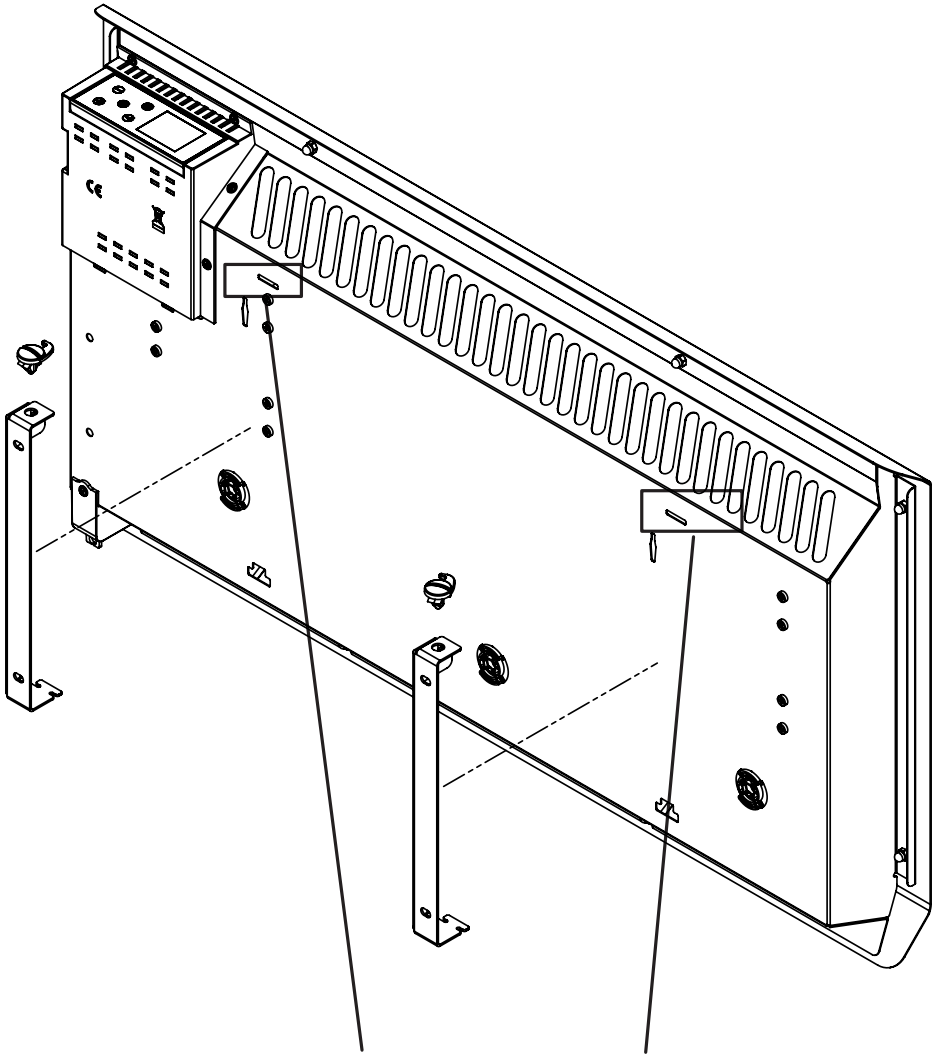

USO CORRECTO

Utilizar el producto como se muestra en la figura 1. Nunca cubrir completamente el aparato con toallas. Averiguar con personal experto la posibilidad de instalar el aparato en baños o en habitaciones con presencia de agua.

El uso incorrecto puede provocar peligrosos sobrecalentamientos y comprometer el funcionamiento del aparato.

Para limpiar el aparato, no utilizar productos químicos, sino solo un paño húmedo no abrasivo.

1



2

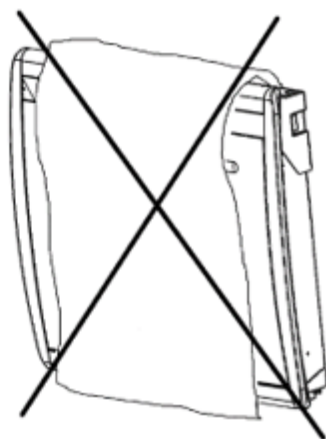

CARACTERÍSTICAS DE LA INTERFAZ DEL USUARIO



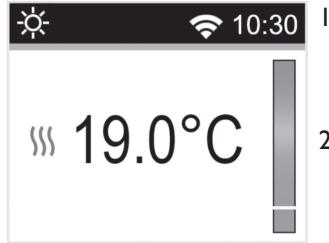

Display

El display dispone de retroiluminación.

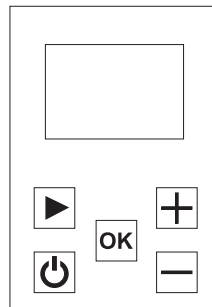

1. información sobre modo operativo/menú del termostato, hora y conexión WiFi
2. Información sobre:
 - modo operativo del termostato: ajuste de la temperatura, indicador de comportamiento, temperatura medida, indicador de calefacción del radiador;
 - configuración de los parámetros: indicación del valor efectivo de los parámetros;
 - selección del programa para el modo AUTO; el teclado comprende 5 tecla



| | |
|---|--|
|  | Tecla ON/OFF (Calefacción encendida / apagada) |
|  | Tecla menos |
|  | Tecla de validación |
|  | Tecla más |
|  | Tecla de navegación |

PRIMER ENCENDIDO E INSTALACIÓN

Cuando se enciende el termostato o después de haber restablecido el producto, se visualiza esta primera pantalla.

El número correspondiente de la versión del software del producto. La segunda pantalla varía de acuerdo del estado del termostato:

- Con el primer encendido del producto, el usuario podrá configurar directamente la conexión WiFi, la fecha y hora.

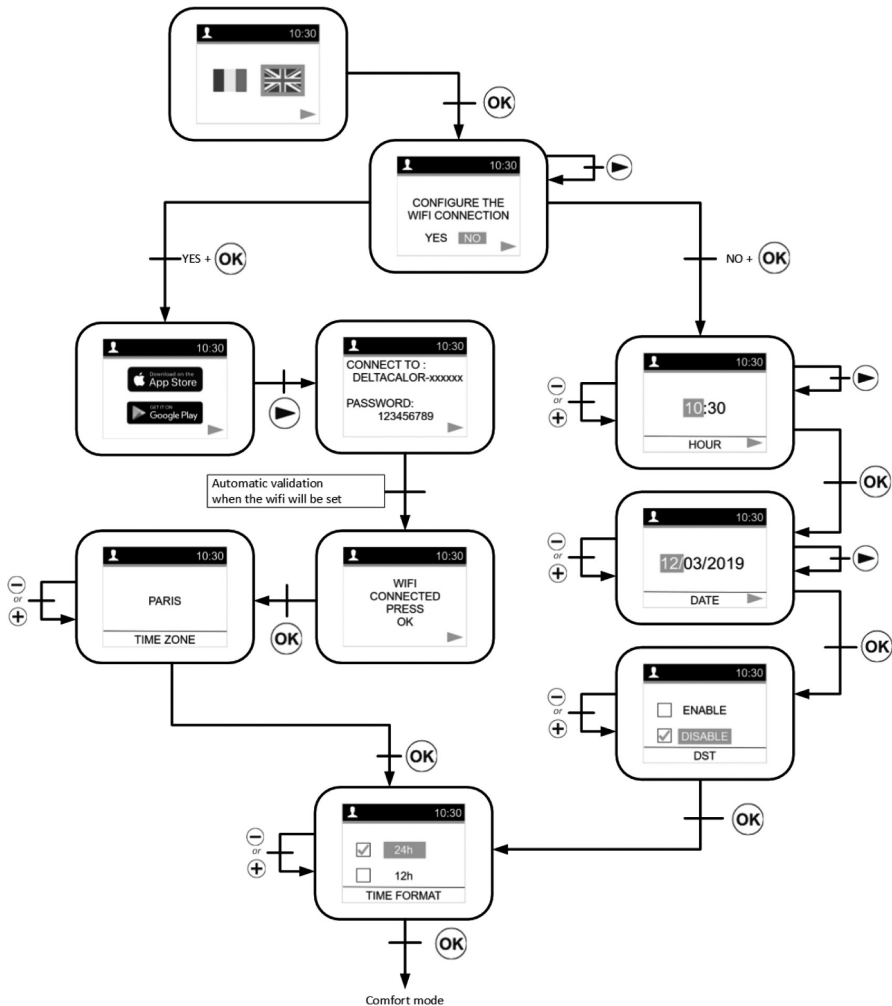

Ir a la página 126 para configurar un radiador y asociarlo a la propia red WiFi usando la aplicación “DELTA CALOR CONFORT”.

A consecuencia de una interrupción de corriente, aparecerá la pantalla del modo activo. Después de un restablecimiento del producto o una interrupción prolongada de la corriente, aparecerá la pantalla de modificación de hora.

MENÙ DE SELECCIÓN DE LA MODALIDAD

Para modificar el modo activo del termostato, pulsar el botón de navegación derecho ► para acceder a la selección del menú.

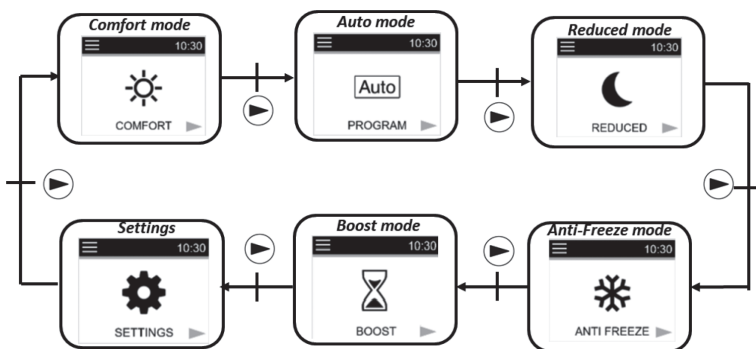

Mover el curso para escoger una modalidad operativa. Para seleccionar un modo, pulsar **OK**.

Confirmar el modo escogido pulsando el botón **OK** de lo contrario el termostato regresa automáticamente al último modo seleccionado **☐**, **☒**, **☑**, o **[Auto]**.

Pulsando **⏪**, es posible acceder directamente al modo de inicio/parada de calefacción:



Si no se presiona ninguna tecla durante 5-10 segundos, aparecerá un screen saver. Este screen saver podría mostrar el valor de la temperatura medida o nada:



Definición de las modalidades operativas

Modo Comfort ☀

En este modo, seguirá siempre la temperatura confort configurada. En el screen saver (retroiluminación activa), pulsando el botón **⊖** o **⊕**, la temperatura de la configuración confort comienza a parpadear y es posible modificarla. Presionando la tecla **OK** o esperando 15 segundos sin efectuar ninguna intervención, se confirma el valor configurado. Tal configuración se utilizará en modo **Auto** durante la fase alta del programa seleccionado ☒.

Desde el screen saver (retroiluminación activa), pulsando **OK** es posible pasar de la visualización de la temperatura medida a la configurada

Pulsando el botón **▶**, se visualiza el menú de navegación.

Pulsando el botón **⏻**, se desactiva el termostato.

Valor predefinido: 19 °C.

Intervalo: da 10 a 30 °C (el valor máximo es modificable en el menú de los parámetros).

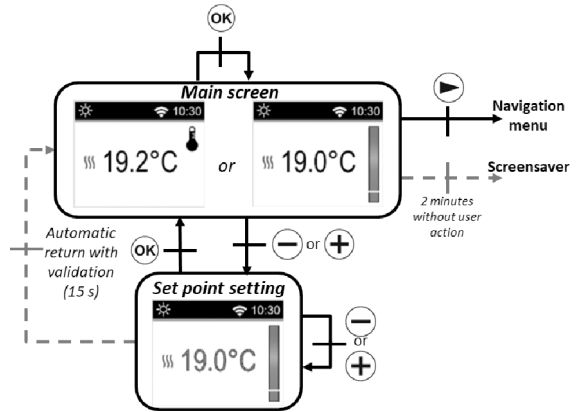

Modo Eco ☾

En este modo, el producto funciona con una temperatura reducida configurada.

Desde el screen saver (retroiluminación activa), pulsando el botón **⊖** o **⊕**, la temperatura de configuración reducida comienza a parpadear y es posible modificarla.

Presionando el botón **OK** o esperando 15 segundos sin efectuar ninguna intervención, se confirma el valor configurado.

Tal configuración se utilizará en modo

Auto durante la fase alta del programa seleccionado ☾.

Desde el screen saver (retroiluminación activa), el botón **OK** permite pasar de la visualización de la temperatura medida a la configurada

Pulsando el botón **▶**, se visualiza el menú de navegación.

Pulsando el botón **⏻**, el termostato se desactiva

Valor predefinido: 17°C.

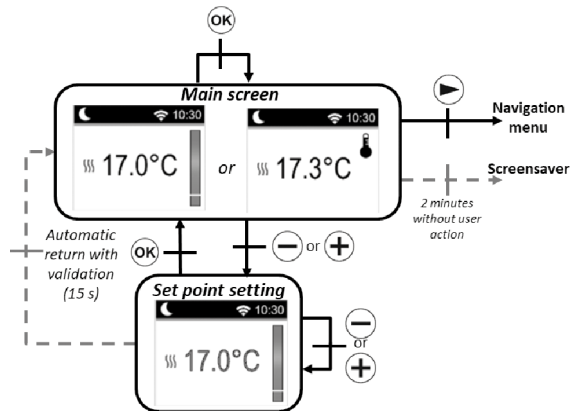

Intervalo: de 5,0 a 19 °C (o valor configurado inferior a 0,5°C, si inferior).



Modo automático

En este modo, el termostato seguirá el programa escogido (de P1 a P9 integrados o de U1 a U2 personalizados) en base a la hora y la temperatura de configuración Comfort y reducida .

En la pantalla principal, el botón  permite pasar de la visualización de la temperatura medida a la de la temperatura de configuración.

Pulsando los botones  y , es posible ignorar, hasta la fase sucesiva del programa y por 2 horas, la temperatura del programa en uso modificando su valor. El valor comienza a parpadear y se puede modificar.

Presionando el botón  esperando 15 segundos sin efectuar ninguna intervención, se confirma el valor configurado.



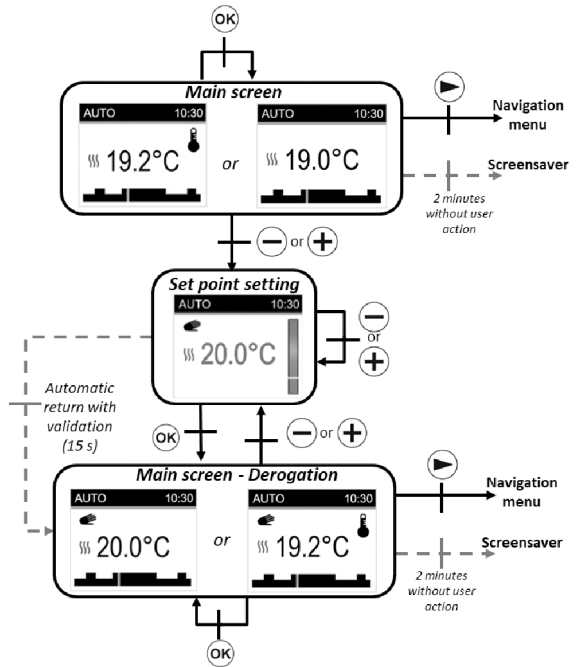

El símbolo de la mano se visualiza cuando la función de superación se encuentra activa. Este rebasamiento continúa hasta la fase sucesiva (el programa pasa a otro valor de temperatura) o por un máximo de 2 horas.

Pulsando el botón , se visualiza el menú de navegación.

Pulsando el botón , el termostato se desactiva



Modo anticongelante

En este modo, se seguirá siempre el valor de la temperatura configurada para la protección anticongelante. En la pantalla principal, pulsando los botones  y , el valor configurado de la temperatura para la protección anticongelante comienza a parpadear y se puede modificar. Presionando el botón  o esperando 15 segundos sin efectuar ninguna intervención, se confirma el valor configurado. En el protector de pantalla (retroiluminación activa),  permite cambiar la visualización de la temperatura medida a la configuración de temperatura.

Pulsando el botón , se visualiza el menú de navegación.

Pulsando el botón , el termostato se desactiva.



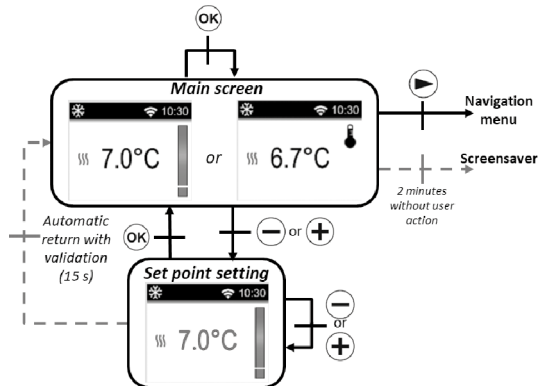

Valor predefinido: 7°C.

Intervalo: de 0,5 a 10 °C



Modo Calefacción apagada

En modo de Calefacción apagada, el símbolo se visualiza en modo OFF .

Después de haber apretado uno de los 4 botones ( o  o  o ) , se visualiza la temperatura medida. Después de algunos segundos, dicha información no vuelve a visualizarse.

Este modo aplica una temperatura de referencia equivalente a cero.

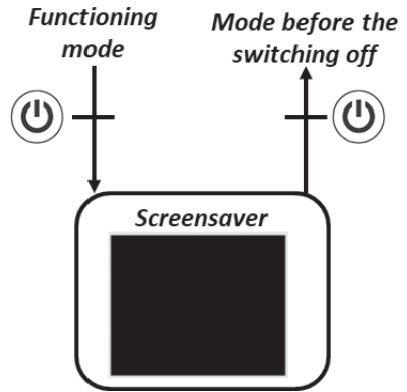

Pulsando sobre el botón  , el termostato se reactiva en el último modo seleccionado.



Modo Boost

Este modo permite aumentar la calefacción con la temperatura máxima configurada por un intervalo de tiempo pre-configurado.

Configuración del intervalo de tiempo:

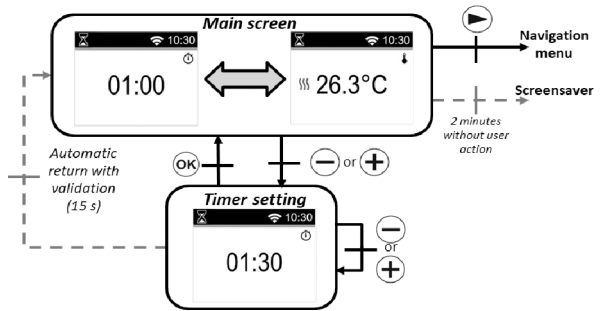

El valor de tiempo se configura utilizando los botones  y  . El botón valida el valor temporal y el periodo de aumento rápido.



VValor predefinido: 1 hora

Intervalo de valores: 30 minutos, de 1H a 24 H, intervalos de 1 hora

Con el modo boost activo, se visualizan el tiempo restante y la temperatura medida.

Pulsando  o  es posible modificar las configuraciones.

Pulsando el botón  por un segundo se accede al menú de selección de la modalidad.

Pulsando el botón  se apaga el producto y se restablece el timer.

Definición del menú “CONFIGURACIÓN”

Accediendo al menú “CONFIGURACIÓN”, es posible escoger entre diversos grupos de parámetros o acciones:

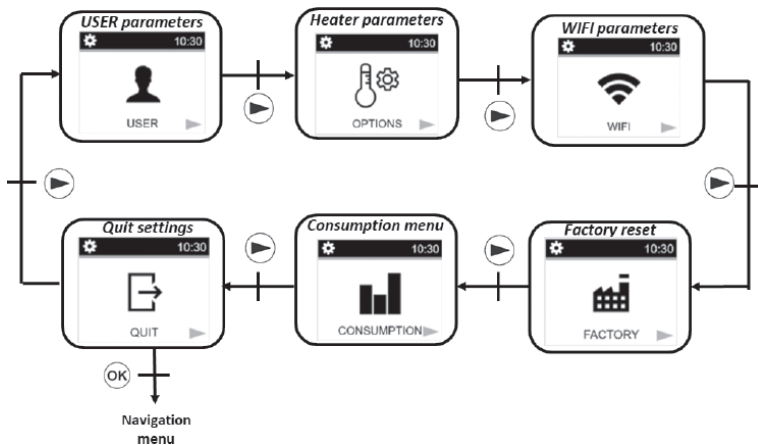

Para seleccionar un menú, presionar el botón **OK**. Es posible moverse en el interior del menú utilizando el botón **▶**. Para salir del menú de los parámetros, seleccionar la opción “SALIR” y pulsar el botón **OK**.

Otro modo para salir del menú de los parámetros es mantener apretado por algunos segundos el botón **▶**.

Configuraciones del usuario

El menú de configuración de los parámetros se selecciona presionando el botón **▶**.

La configuración es posible presionando el botón **OK**. Para salir del menú de los parámetros, seleccionar la opción “SALIR” y pulsar el botón **OK**.

Otro modo para salir del menú de los parámetros es mantener apretado por algunos segundos el botón **▶**.

| | |
|--|--|
| <p>La pantalla muestra un ícono de un termómetro y el texto 'UNITS' con un botón de navegación a la derecha. En la parte superior hay un ícono de usuario y el tiempo '10:30'.</p> | <p>Unidad de medida de los grados «UNIDAD»</p> <p>Valor predeterminado: °C (Celsius) Otra opción: °F (Fahrenheit)</p> |
|--|--|

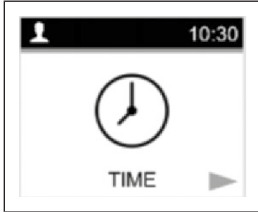

Menú «FECHA Y HORA» para configurar la hora y la fecha

Existen dos modos para configurar la hora y la fecha del termostato en base al estado del WiFi (activo o no):

PRIMER METODO: WIFI DESACTIVADO

Modificación de la hora:

Seleccionar la hora y los minutos con el botón Modificar los valores utilizando y . Confirmar las configuraciones con el botón .

Formato de la hora:

Seleccionar el formato 24H o AM/PM utilizando los botones y . Confirmar las configuraciones con el botón .

Cambio automático de la hora:

Seleccione si desea que se cambie automáticamente la hora (hora legal) usando los botones y . Confirmar las configuraciones con el botón .

Modificación de la fecha:

Seleccionar el día, el mes o el año con el botón . Modificar los valores utilizando los botones y . Confirmar las configuraciones con el botón .

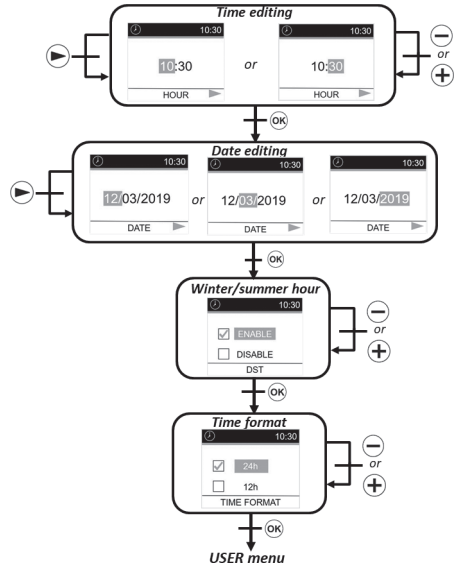

SEGUNDO MÉTODO: WIFI ACTIVO

Huso horario:

Seleccionar el huso horario local utilizando los botones y . Confirmar la configuración con el botón .

Formato de la hora:

Seleccionar el formato 24H o AM/PM utilizando los botones y . Confirmar la configuración con el botón .

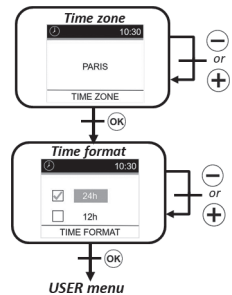

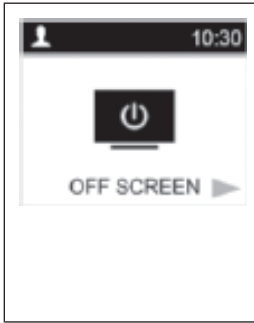

PANTALLA VIDEO OFF

Cuando no se encuentra activa ninguna modalidad, la pantalla aparece como se muestra a continuación:

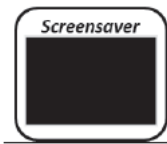
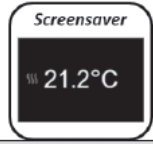

Valor predeterminado: ninguno
Otra opción: Temperatura medida (7h00 a 23h00)

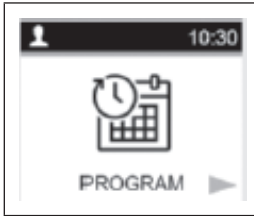

Programa

Este menú le permite seleccionar la programación que se aplicará en el modo automático AUTO

Programa:

Seleccione «Selección» con el botón .
Confirmar la configuración utilizando el botón .

Selección:

Seleccione el número de programa con el botón . Seleccione el día con los botones y .

Confirme el número de programa con el botón .

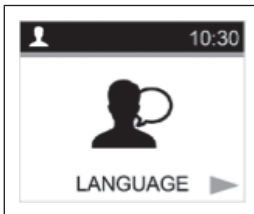
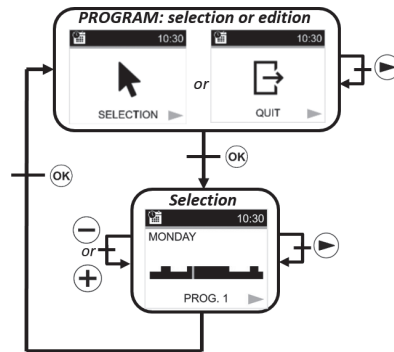

Selección de idioma

Valor predeterminado: Inglés
Otra opción: Francés, italiano, alemán y español

| | |
|---|--|
|  | <p>Salir del menú de configuración Si presiona el botón OK puede salir del menú de configuración de USUARIO y regresar al menú de CONFIGURACIONES.</p> |
|---|--|

Opciones y configuraciones del radiador

El menú de configuración de los parámetros se selecciona presionando el botón **▶**. La configuración es posible presionando el botón **OK**.

Para salir del menú de los parámetros, seleccionar la opción "SALIR" y pulsar el botón **OK**. Otro modo para salir del menú de los parámetros es mantener apretado por algunos segundos el botón **▶**.

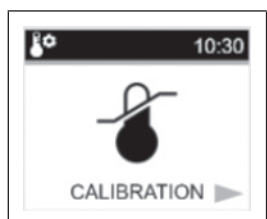
| | |
|---|--|
|  | <p>Calibración del sensor de temperatura: Ejecute la calibración después de 1 día de uso con la misma temperatura de configuración que se describe a continuación</p> |
|---|--|

1. Coloque un termómetro en la habitación, a una distancia del piso igual a la del termostato. Verifique la temperatura real en la habitación después de 1 hora.
2. Ingrese este valor en el menú de parámetros de calibración usando los botones **-** y **+** para ingresar el valor real.
3. Presione **OK** para confirmar la calibración

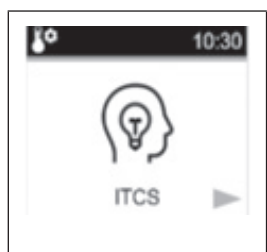
| | |
|--|--|
|  | <p>ITCS - Intelligent Temperature Control System (calefacción con arranque adaptativo en modo AUTO) Esta función se describe en el párrafo «Funciones especiales». Esta configuración le permite activar o no esta función.</p> <p>Valor predeterminado: Sí (activación de la función) Otras opciones: No</p> |
|--|--|

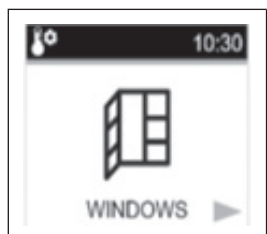

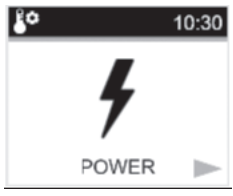
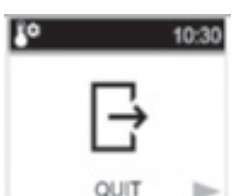
| | |
|---|---|
|  | <p>Detección automática de ventanas abiertas Esta función se describe en el párrafo «Funciones especiales». Esta configuración le permite activar o desactivar esta función.</p> <p>Valor predeterminado: Sí (activación de la función) Otras opciones: No</p> |
|---|---|

| | |
|---|---|
|  | <p>Potencia de calefacción Este parámetro corresponde a la potencia del calentador. Es necesario configurar este parámetro para calcular el consumo energético y seleccionar los parámetros de regulación.</p> <p>Valor predeterminado: 900 Otras opciones: 1000, 1500, 1800, 2000</p> |
|  | <p>Límite de potencia Este parámetro le permite reducir manualmente la potencia del radiador.</p> <p>Valor predeterminado: NO (100%) Otras opciones: NO (100%)/75%/50%</p> |
|  | <p>Programación de temperatura con boost Valor de temperatura configurado con el modo boost activo.</p> <p>Valor predeterminado: 30°C Otras opciones: 20 a 30°C</p> |
|  | <p>Limitación de la temperatura ambiente Limitación de temperatura ambiente máxima ajustable de forma remota.</p> <p>Valor predeterminado: 30°C Otras opciones: 20 a 30°C</p> |
|  | <p>Salir del menú de parámetros Pulsando el botón OK es posible salir del menú de parámetros y volver al funcionamiento normal</p> |

Configuración WIFI

El menú de configuración de los parámetros se selecciona presionando el botón **▶**. La configuración es posible presionando el botón **OK**. Para salir del menú de los parámetros, seleccionar la opción “SALIR” y pulsar el botón **OK**. Otro modo para salir del menú de los parámetros es mantener apretado por algunos segundos el botón **▶**.

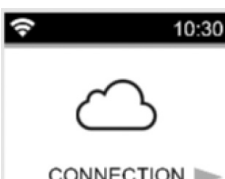

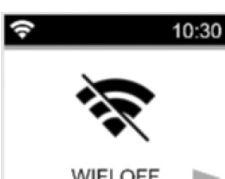
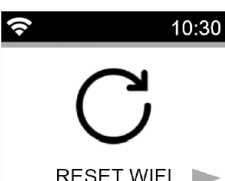
| | |
|---|---|
|  | <p>INFORMACION WIFI:</p> <ul style="list-style-type: none"> • Este menú muestra información sobre la WIFI: • Estado de conexión: CONECTADO, Modo AD HOC, NO CONECTADO y CONEXIÓN; • SSID; • Dirección IP; • Dirección MAC; |
|  | <p>CONEXIÓN</p> <p>Habilita la conexión a la nube del producto. Nota: el producto debe configurarse en modo ad hoc antes de activar la conexión (ver más abajo)</p> |
|  | <p>AD HOC (modo directo):</p> <p>Active el modo AD HOC, que le permite configurar la red WIFI utilizando la aplicación. Cuando el termostato funciona en este modo, se ve una antena diferente en la pantalla</p>  |
|  | <p>WIFI OFF</p> <p>Desactivación de la conexión WIFI.</p> |
|  | <p>RESTAURAR LA CONFIGURACIÓN DE WIFI</p> <p>eliminar todas las conexiones WIFI configuradas.</p> |



SALIR DEL MENÚ

Presione el botón **OK** para salir del menú WIFI.

Restablecer la configuración de fábrica

Todos los ajustes del termostato se cargarán con los ajustes de fábrica.

Al presionar el botón **OK**, el termostato restablece la configuración.

El termostato restablece los siguientes valores a las configuraciones predeterminadas de fábrica:

- temperaturas nominales;
- configuración;
- hora;
- consumo de energía;
- configuración WIFI.



Menú de registro de consumo

Este modo está disponible solo si el usuario ha configurado la potencia del radiador.

Presione **▶** para cambiar el intervalo de tiempo para ver el consumo de energía (últimas 24 horas, últimos 7 días y duración 30 días).

Si no se presiona ningún botón, el termostato volverá automáticamente al modo previamente seleccionado

Presione **OK** para volver al menú CONFIGURACIONES.

Pulsando **-** o **+** unos segundos se restablecen los valores de consumo de energía.

Otro modo para salir del menú de los parámetros es mantener apretado por algunos segundos el botón **▶** por algunos segundos. Presione **⏻** para apagar el producto.

Los valores estimados se guardan en la memoria cada 4 horas y cada vez que el usuario visualiza este menú.

Si el APAGADO está activo, los valores se mantienen durante las siguientes 12 horas.

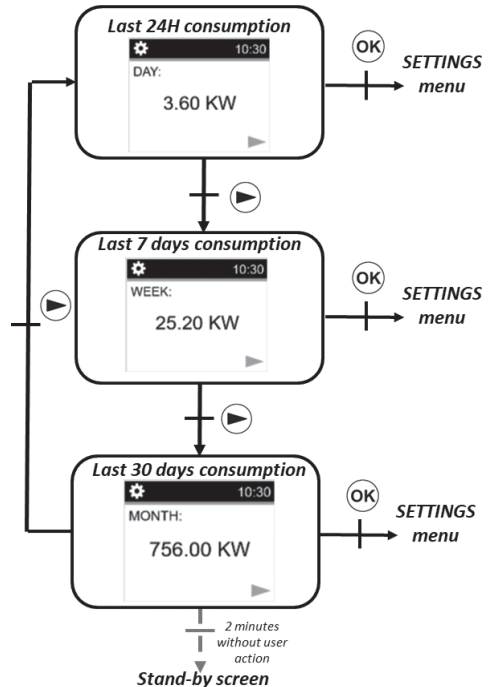
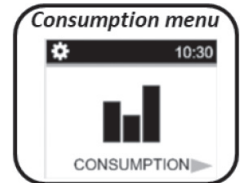

Descripción del programa integrado

- P1: mañana (7h-9h), tarde (17h-23h) y fin de semana (8h-23h)
- P2: mañana (7h-9h), mediodía (12h-14h), noche (18h-23h) y fin de semana (8h-23h)
- P3: día (6h-23h), sábado (7h-24h) y domingo (noche (0h-1h), día (7h-23h))
- P4: noche (15h-23h) y sábado (7h-24h) y domingo (noche (0h-1h), día (7h-23h))
- P5: mañana (6h-8h), noche (21h-23h) y sábado (mañana 7h-9h), noche 18h-24h) y domingo (mañana (7h-9h), noche (18h-23h))
- P6: mañana (6h-8h) mediodía (14h-21h) y fin de semana (7h-21h)
- P7: oficina de lunes a viernes (7h-19h) y fin de semana (off)
- P8: Almacén: de lunes a viernes (8h-19h) y sábado (8h-18h) y domingo (apagado)
- P9: Segunda casa: de viernes (13h) a lunes (7h)

Guardar las configuraciones

Este termostato guarda automáticamente los datos (valores establecidos, programa de usuario y configuraciones) cuando:

1. El usuario valida los cambios realizados en las configuraciones presionando el botón de validación.
2. La luz de fondo del producto se apaga.

También almacena los valores estimados de consumo energético:

1. Cada 4 horas
2. Cuando el usuario entra en modo consumo

Funciones especiales

ITCS: Sistema de control de temperatura inteligente

Esta función se puede activar a través del elemento «ITCS» en el menú de Parámetros (ver el capítulo «Menú de parámetros»).

Permite activar el sistema por adelantado (2 horas máximo) cuando el termostato está en modo Auto. Además, garantiza la temperatura deseada a la hora programada según el programa semanal.

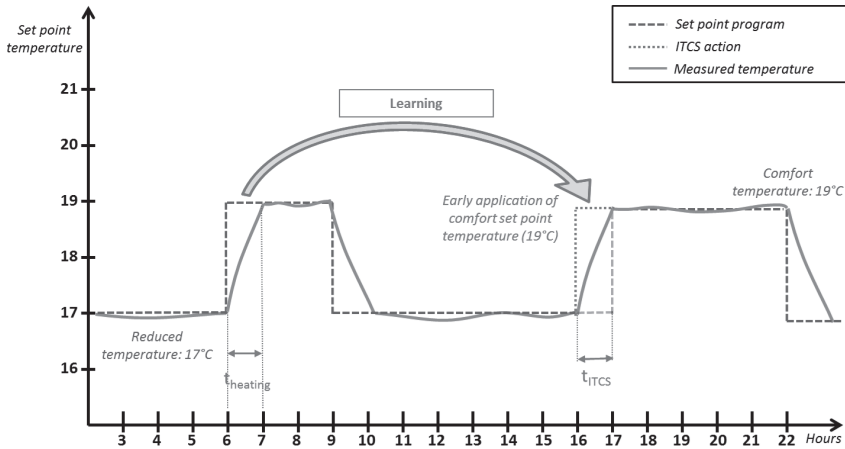

Para funcionar, el sistema ITCS sigue automáticamente varias mediciones de temperatura en varios momentos. El objetivo es estimar la tasa de calefacción del sistema. Con este valor, el sistema puede calcular de antemano cuándo activar la calefacción. Cuando el termostato se enciende por primera vez, se usa un período de tiempo predefinido para alcanzar la temperatura establecida. Este valor se ajustará mediante nuevas mediciones en cada cambio de programa para compensar los cambios en la temperatura exterior. Por tanto, es posible programar el termostato sin regulación porque se realizará de forma automática. Si el sistema realiza un arranque adaptativo, el icono de la mano aparece en la pantalla.

Detección de ventana abierta

Esta función se puede activar en la opción «ventana» en el menú de parámetros. Se realiza midiendo y registrando el cambio de temperatura en los últimos 20 minutos:



- Primer paso con la detección de ventana abierta activa: el termostato cambia al estado «Ventana abierta»  (y el valor de temperatura parpadea) cuando la temperatura desciende más de 1.5°C en los últimos 20 minutos, con el producto encendido y en fase de calefacción.
- Segundo paso: si la temperatura supera los 0.3°C en 20 minutos, se elimina el estado de ventana abierta y el termostato vuelve automáticamente al valor de modo actual.

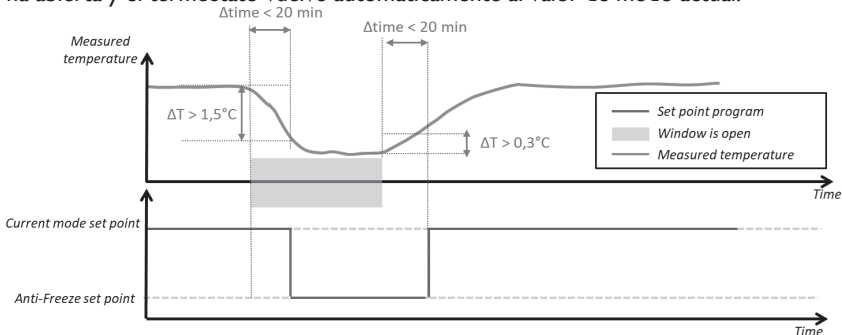

Copia de seguridad de datos en caso de un corte de energía prolongado

Este producto puede continuar contando el paso del tiempo durante 12 horas después de un corte de energía.

Si el corte de energía dura demasiado, la hora y la fecha se restablecerán a los valores predeterminados de fábrica. Por tanto, será necesario reconfigurar estos valores.



Bloqueo de teclado

Para activar esta función es necesario presionar simultáneamente los botones \ominus o \oplus por 5 segundos. Todos los botones están bloqueados excepto Iniciar/ detener calefacción \odot .

Esta función es accesible en cualquier Modo. En la pantalla aparece el icono \mathfrak{L} para desbloquear el teclado, debe repetir el mismo procedimiento. NOTA: en caso de fallo de alimentación se mantiene la configuración.

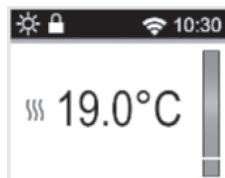

Modo de control de hilo piloto

| Comando de hilo piloto | Captura de pantalla | Comando de hilo piloto | Captura de pantalla |
|------------------------|---------------------|------------------------|---------------------|
| Confort | | ECO | |
| Confort-1° | | Anticongelante | |
| Confort -2° | | Stand-by | |

Prioridad en órdenes de hilo piloto

| Modo configurado en termostato | Comando desde el hilo piloto | Modo real establecido |
|--------------------------------|------------------------------|---|
| Modo AUTO (confort) | Confort | Confort |
| | Confort -1°C | Confort -1°C |
| | Confort -2°C | Confort -2°C |
| | Confort -3.5°C / eco | Valor más bajo entre "Confort -3,5 y 19°C" |
| | Anticongelante | Anticongelante |
| | Stop | Stop |
| Modo AUTO (eco) | Confort | Temperatura ajustada en modo ECO |
| | Confort -1°C | |
| | Confort -2°C | |
| | Confort -3.5°C / eco | Valor inferior entre la temperatura ajustada en modo ECO y "Confort -3,5°C" |
| | Anticongelante | Anticongelante |
| | Stop | Stop |
| Modo AUTO (manual) | Confort | Temperatura configurada manualmente |
| | Confort -1°C | |
| | Confort -2°C | |
| | Confort -3.5°C / eco | |
| | Anticongelante | |
| | Stop | |

Si la detección de ventana abierta  está activa, y si esta función detecta apertura, el termostato sigue las reglas presentadas en el párrafo «Detección de ventana abierta». El termostato muestra el valor de temperatura establecido aplicado al calentador. Tenga en cuenta el orden de prioridad presentado anteriormente.

Descripción de errores

Si el sensor está apagado o desconectado, aparecerá un mensaje de error en la pantalla del termostato. APLICACIÓN PARA DISPOSITIVOS MÓVILES (SMARTPHONE)

| | | |
|---------------------------|---|--|
| Problema del sensor |  | el mensaje «-» está acompañado por el icono  parpadeante y el logotipo  en la pantalla. |
| Problema de conexión WIFI |  | El logo de WIFI está rojo |

APLICACIÓN PARA DISPOSITIVOS MÓVILES (SMARTPHONE)

Indicaciones generales

La aplicación está disponible solo para plataformas IOS y Android



La aplicación te permite configurar el WIFI y controlar remotamente el radiador. Primero, descargue la aplicación gratuita «DELTACALOR CONFORT»



en su dispositivo móvil celular (smartphone). Gracias a la aplicación, es posible agregar un dispositivo a la aplicación y configurar la red WIFI.

1. Haga clic en «lista de mis sistemas» para ver el sistema existente o agregar uno nuevo.

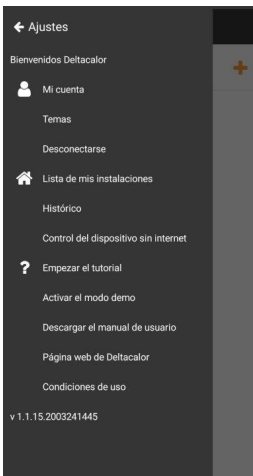

2. Haga clic en el signo “más” para agregar un nuevo dispositivo.

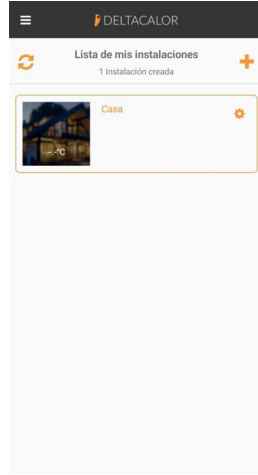

3. Verifique la conexión WIFI.

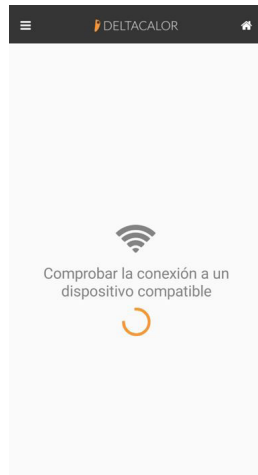

4. Si el smartphone no está conectado, acceda a las configuraciones WIFI del teléfono haciendo clic en Configuración WIFI. Luego regrese a la aplicación.

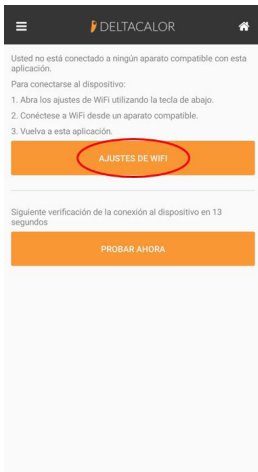

5. Cree la instalación, el nuevo producto y agregue el nombre del dispositivo.

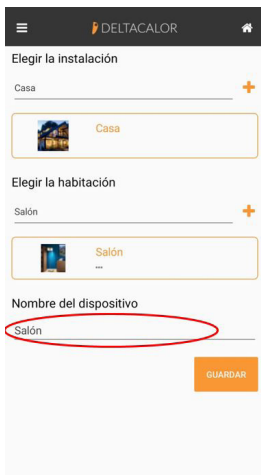

6. Guardar la configuración



7. Conecte el producto a Internet, elija la red e ingrese la contraseña

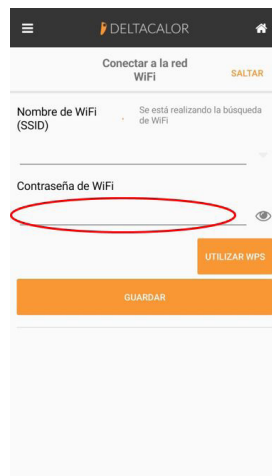

8. Presione el botón hasta que se complete la configuración de red del dispositivo.

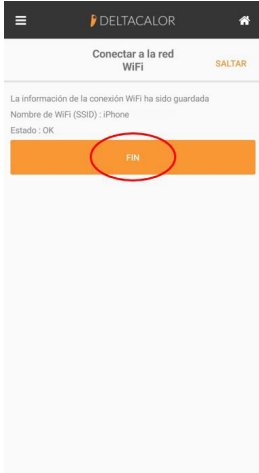

- Puede elegir entre modo Eco, Protección anticongelante o Auto con una reducción impuesta por el administrador de energía. Cambiar al modo Confort permanente o aumentar el valor establecido.
- Comprobar que el dispositivo no esté cerca de una salida de aire.
- Comprobar que la temperatura establecida no se haya modificado.

QUÉ HACER SI SURGEN PROBLEMAS

El dispositivo no calienta lo suficiente

- Se puede encontrar en modalidad Eco, Freeze. Cambie a la modalidad de Confort permanente o aumente la temperatura fijada.

El dispositivo se calienta continuamente.

- Comprueba que el dispositivo no se encuentra instalado junto a una corriente de aire.
- Compruebe que la temperatura fijada no ha sido cambiada.

Si el problema persiste, corte la alimentación eléctrica del radiador y espere al menos un minuto antes de restablecerla.

Si el problema persiste, póngase en contacto con la asistencia técnica.

VIDEO TUTORIAL



Para conectar el termostato WI-FI Siga las instrucciones del manual o consulte el video tutorial, disponible en inglés, enmarcando el código QR aquí al lado, con su smartphone.

CARACTERÍSTICAS TÉCNICAS

| | | |
|----------------------------------|--|---|
| Producto | Radiador eléctrico | |
| Aplicacion | Uso doméstico | |
| Clase de aislamiento | CLASE II | |
| Clase IP | IP24 | |
| Color del plastico | Blanco | |
| Colore del cable de alimentacion | Blanco | |
| Seleccion de la temperatura | Numerica | |
| Modalidad de control | Numerica con 5 botones | |
| Modalidad di funcionamiento | Confort, Noche, Anticongelante, ECO, Chrono, Vacaciones, Detección de ventanas abiertas, Protección infantil, Control de arranque adaptativo, Bloqueo de los botones | |
| Rango di temperatura | 0.5 + 30°C | |
| Potencia máxima | 2000W | |
| Banda de frecuencias | De 2400MHz a 2484MHz | |
| Tensión de alimentación | 230Vac 50Hz | |
| Conexiones eléctricas | neutro (gris), fase (marrón), hilo piloto (negro) | |
| Garantía | 2 anos | |
| Normas | EN 60335-1 EN 61000-3-2 EN 62233 EN 55014-1 NFC 15-100 | EN 60335-2-30 EN61 000-3-3 EN 55014-2 |

Productor: DELTACALOR s.r.l

El manual completo de instrucciones está disponible en la página web:

<https://www.deltacalor.com/es/descargar/>

El símbolo , colocado sobre el producto, indica la obligación de entregar el aparato a eliminar en un punto de recogida especializado, conforme a la Directiva 2012/19/UE. En caso de sustitución, el aparato puede ser devuelto al revendedor también. Este producto no queda comprendido dentro de la categoría de los residuos domésticos comunes. Una correcta gestión de su eliminación permite proteger el medio ambiente y reducir la explotación de recursos naturales.

Declaración de conformidad: El fabricante declara, bajo su exclusiva responsabilidad, que el producto objeto del presente manual cumple con los requisitos esenciales de las Directivas de Baja Tensión 2014/35/UE, CEM 2014/30/UE y RoHS 2011/65/UE.



Identificador(es) del modelo: DUNE

| modelo 1000 W | | | |
|---|-------------|---------|--------|
| Partida | Símbolo | Valor | Unidad |
| Potencia calorífica | | | |
| Potencia calorífica nominal | P_{nom} | 1.0 | kW |
| Potencia calorífica mínima (indicativa) | P_{min} | n.d. | kW |
| Potencia calorífica máxima continuada | $P_{max,c}$ | 1.0 | kW |
| Consumo auxiliar de electricidad | | | |
| A potencia calorífica nominal | el_{max} | 1.0 | kW |
| A potencia calorífica mínima | el_{min} | n.d. | kW |
| En modo de espera | el_{SB} | <0,0005 | kW |

| modelo 1500 W | | | |
|---|-------------|---------|--------|
| Partida | Símbolo | Valor | Unidad |
| Potencia calorífica | | | |
| Potencia calorífica nominal | P_{nom} | 1.5 | kW |
| Potencia calorífica mínima (indicativa) | P_{min} | n.d. | kW |
| Potencia calorífica máxima continuada | $P_{max,c}$ | 1.5 | kW |
| Consumo auxiliar de electricidad | | | |
| A potencia calorífica nominal | el_{max} | 1.5 | kW |
| A potencia calorífica mínima | el_{min} | n.d. | kW |
| En modo de espera | el_{SB} | <0,0005 | kW |

| modelo 2000 W | | | |
|---|-------------|---------|--------|
| Partida | Símbolo | Valor | Unidad |
| Potencia calorífica | | | |
| Potencia calorífica nominal | P_{nom} | 2.0 | kW |
| Potencia calorífica mínima (indicativa) | P_{min} | n.d. | kW |
| Potencia calorífica máxima continuada | $P_{max,c}$ | 2.0 | kW |
| Consumo auxiliar de electricidad | | | |
| A potencia calorífica nominal | el_{max} | 2.0 | kW |
| A potencia calorífica mínima | el_{min} | n.d. | kW |
| En modo de espera | el_{SB} | <0,0005 | kW |

NOTE



DELTACALOR

Fabbricato in ITALIA

DELTACALOR s.r.l.
Via Mazzini
23801 • Calolziocorte (LC)
Italia
Tel: +39 0341 644 995
www.deltacalor.com