**E****INSTRUCCIONES DE MONTAJE.**

ADVERTENCIA: Para evitar cualquier riesgo de vuelco, este mueble debe fijarse a la pared utilizando los medios de sujeción adecuados al soporte.

EN**INSTALLATION INSTRUCTIONS.**

WARNING: To avoid any risk of tipping over, this furniture must be fixed to the wall using the appropriate fixing system.

D

MONTAGEANLEITUNG. WARNUNG: Um die Gefahr des Umkippens zu vermeiden, müssen diese Möbel mit den entsprechenden Befestigungsmitteln am Träger und der Wand befestigt werden.

FR**INSTRUCTIONS DE MONTAGE.**

AVERTISSEMENT : Pour éviter tout risque de basculement, ce meuble doit être fixé au mur en utilisant des moyens de fixations adaptés au support.

P**INSTRUÇÕES DE MONTAGEM.**

AVISO: Para evitar qualquer risco de tombamento, esse móvel deve ser fixado na parede usando os meios de fixação adequados ao suporte.

I**ISTRUZIONI DI MONTAGGIO.**

ATTENZIONE: per evitare qualsiasi rischio di ribaltamento, questo mobile deve essere fissato al muro utilizzando dispositivi di fissaggio adeguati al supporto.

CYGNUS BATH
SMART SOLUTIONS

1

A

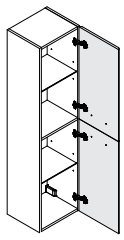

B

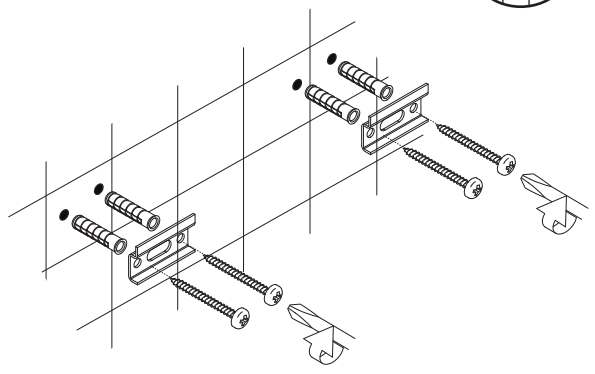
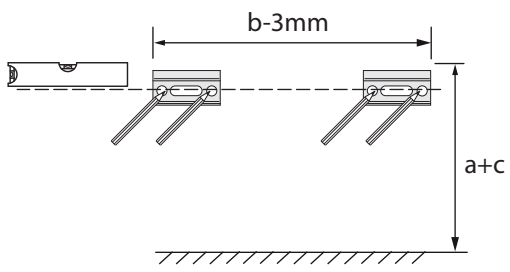
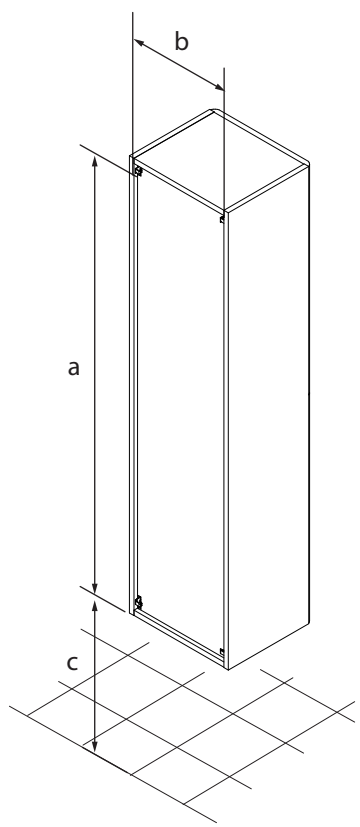
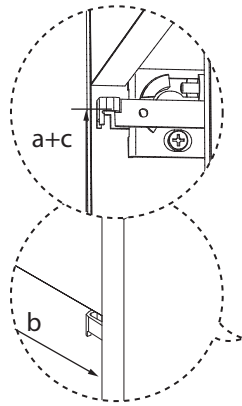
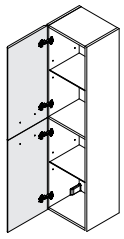

2

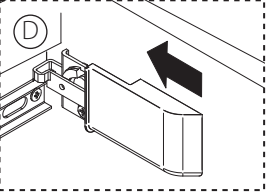
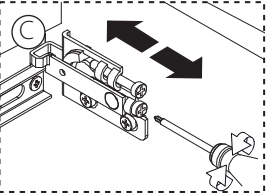
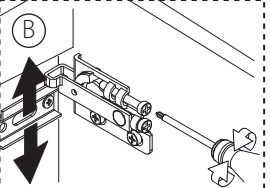
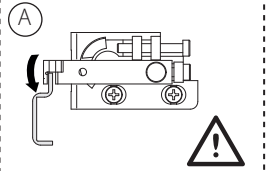
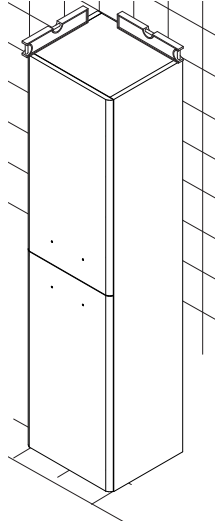
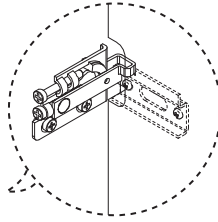
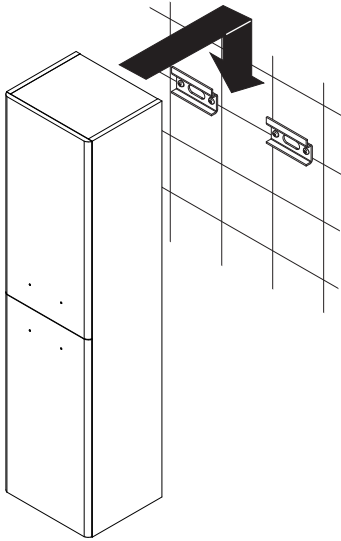

3

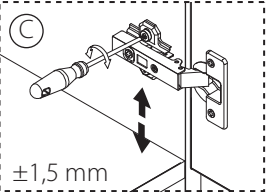
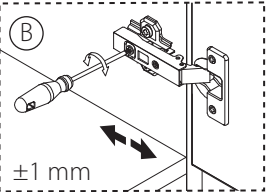
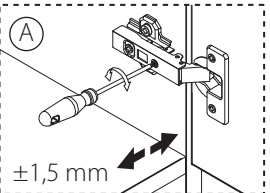
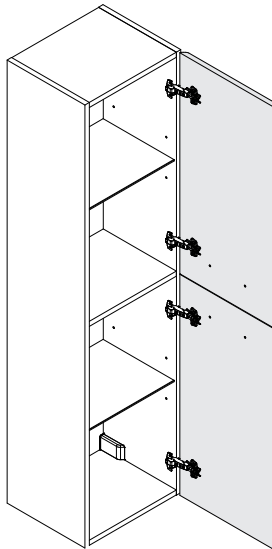
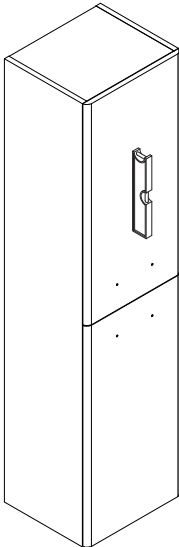

4

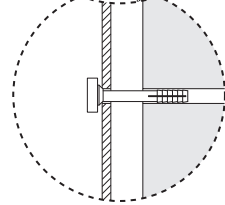
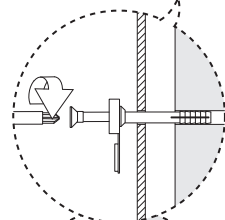
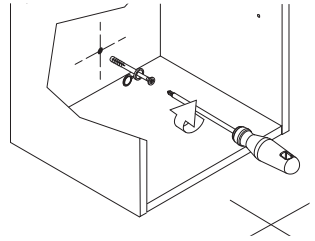
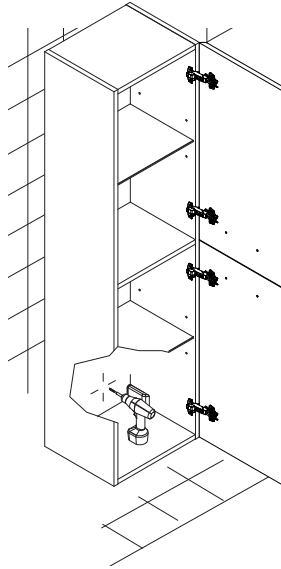
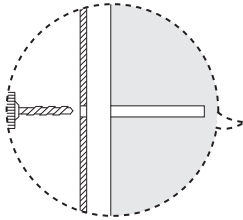
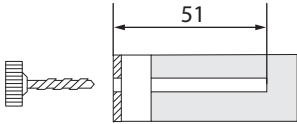

5

