

# COLONNE

Ref.T50414

R.2

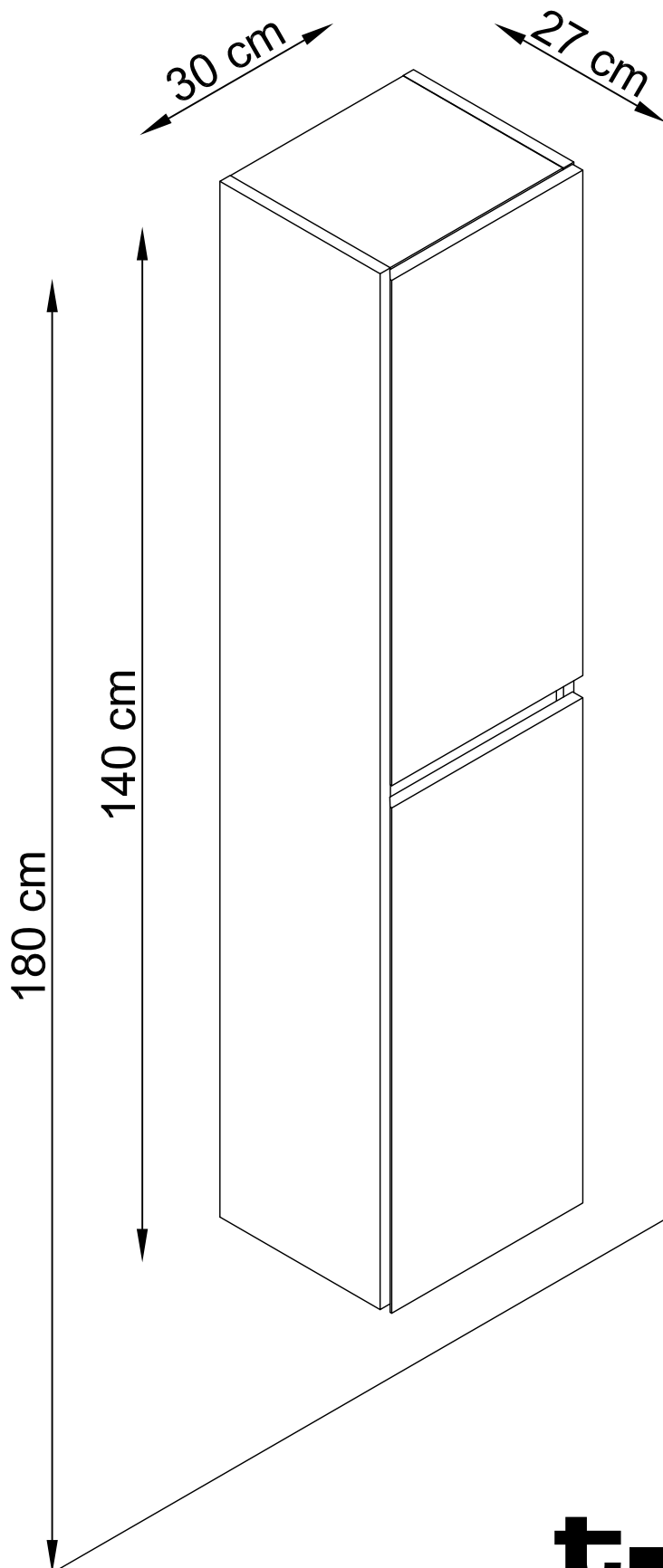

**t-bath**

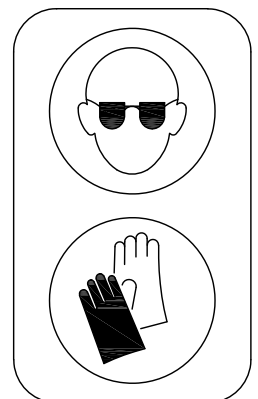
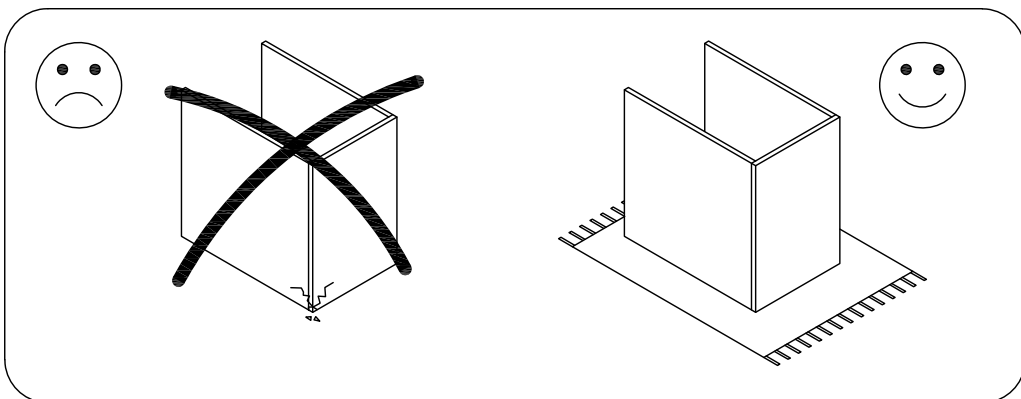
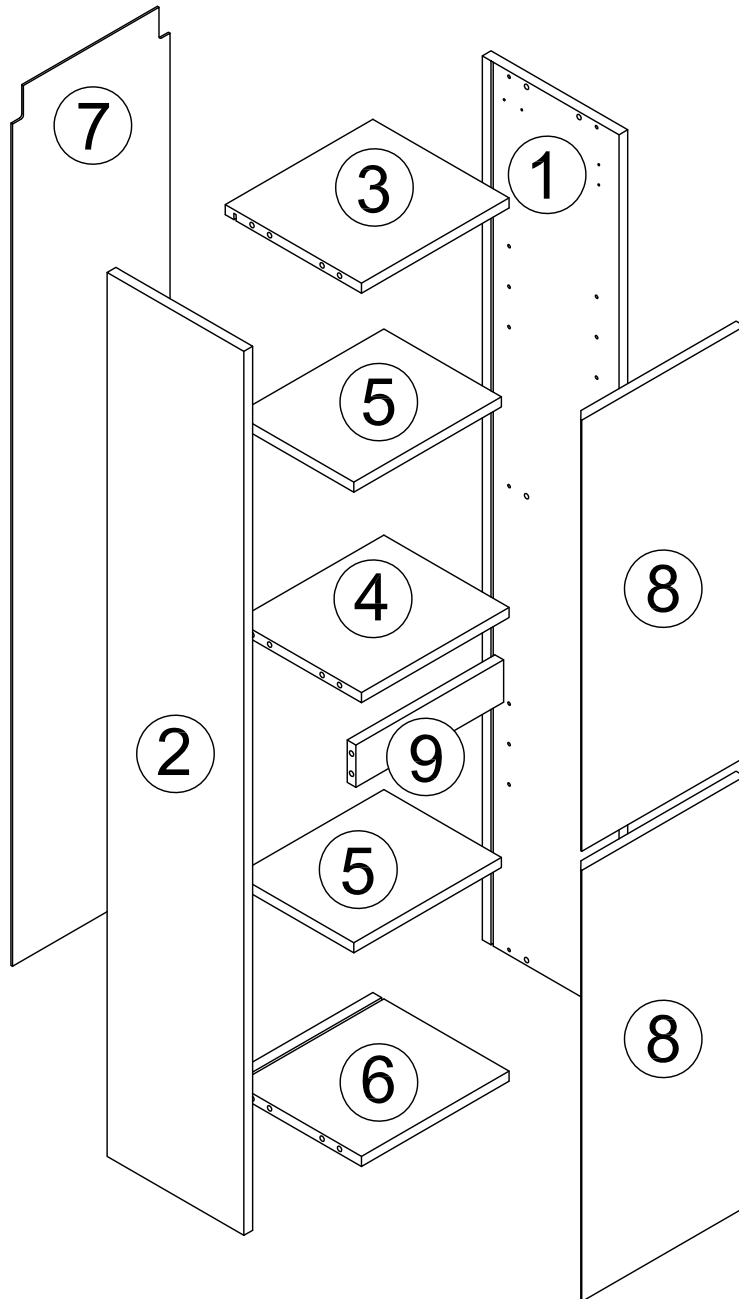
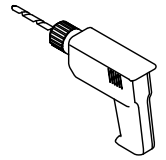
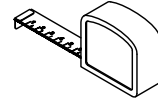
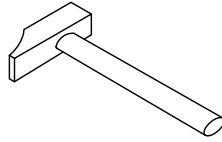
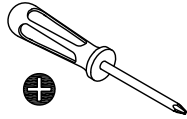
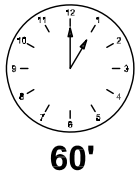

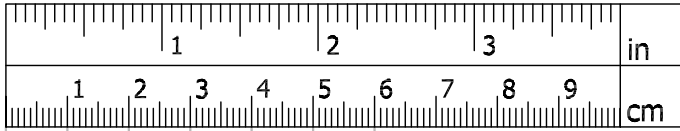

A x16

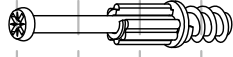

B x12

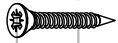

Ta x16

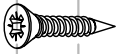

Tb x4

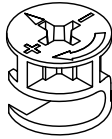

C x12

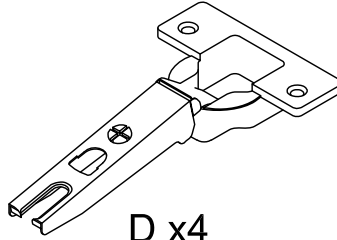

D x4

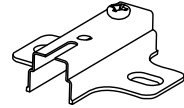

E x4

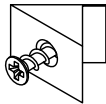

F x4



G x4



H x8

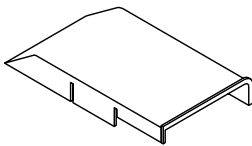

I x1

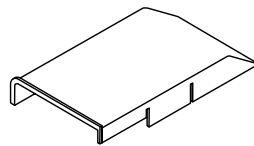

J x1

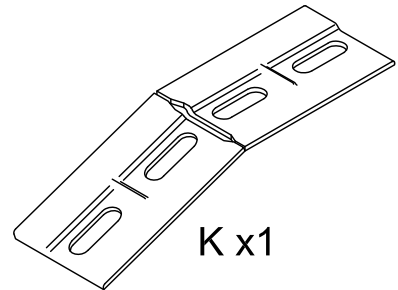

K x1

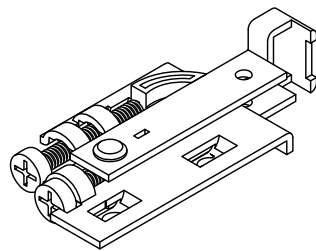

L1 x1

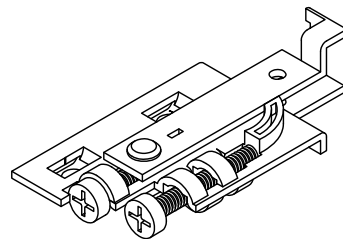

L2 x1

1

B x12

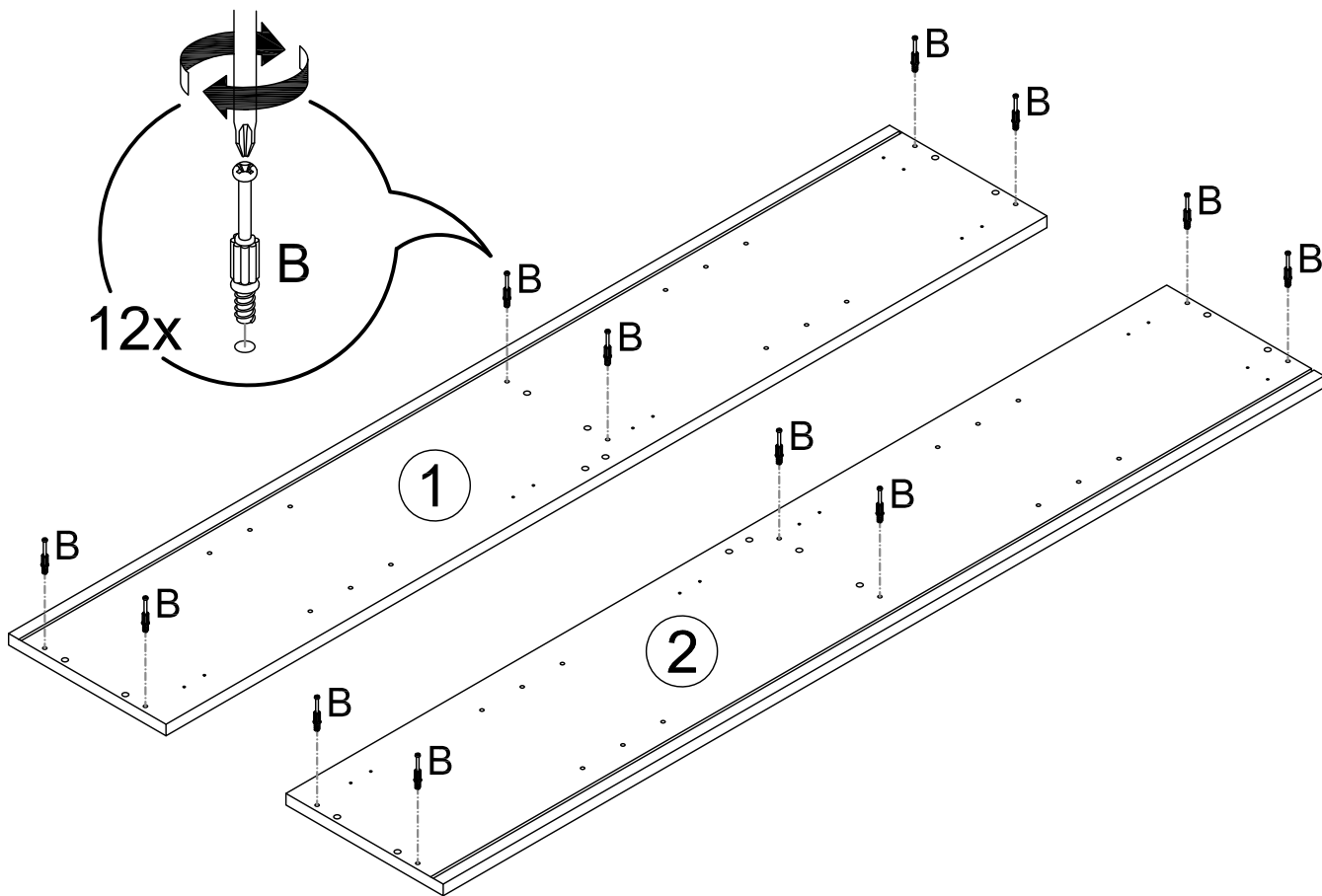
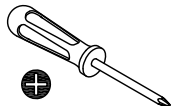

2

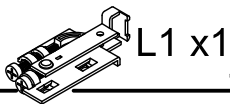

L1 x1

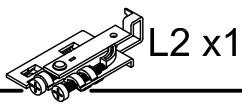

L2 x1



E x4



Ta x8



Tb x4

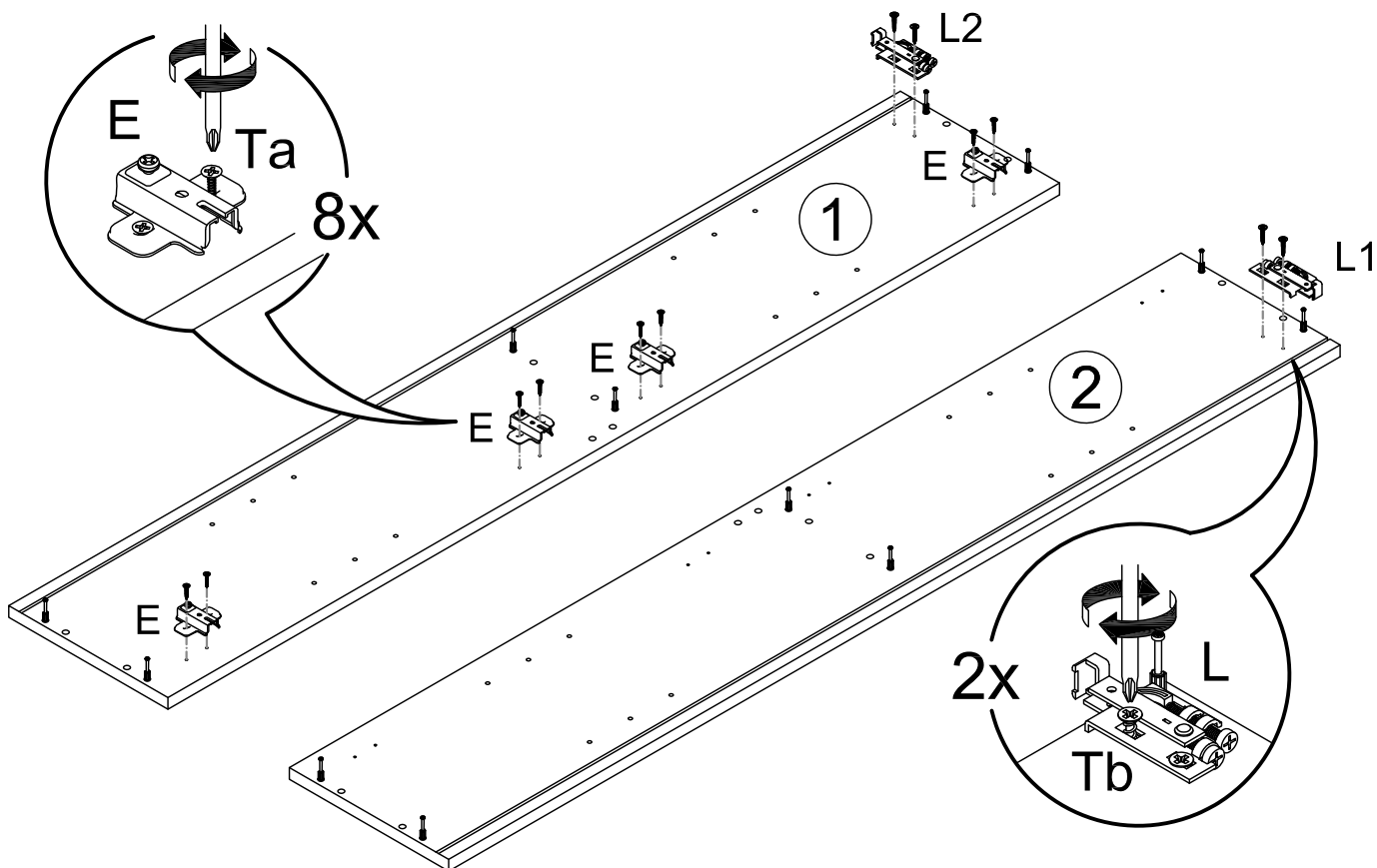
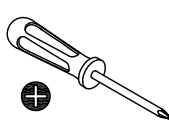

3



A x16



C x12

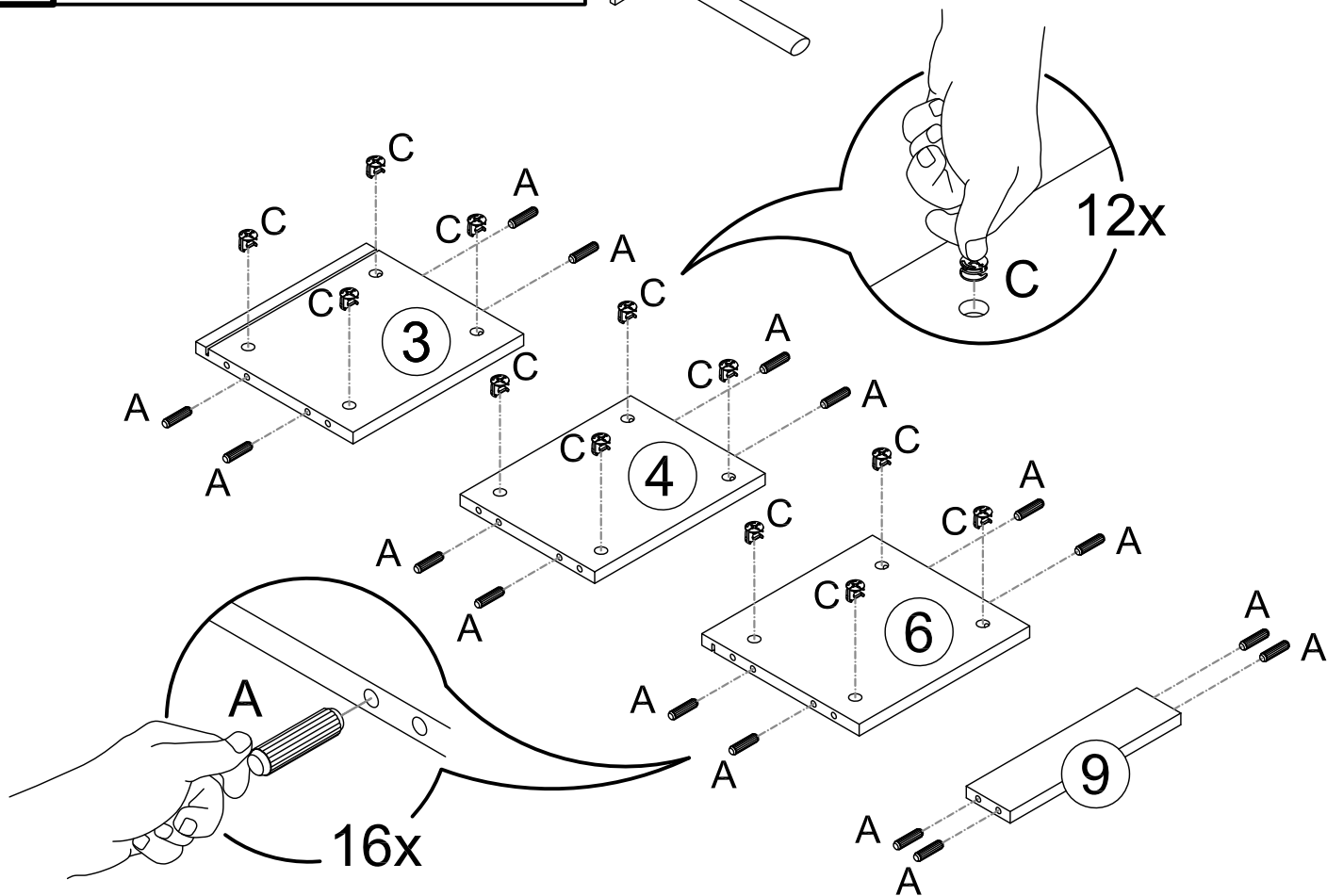
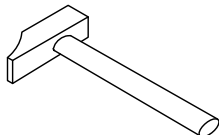

4

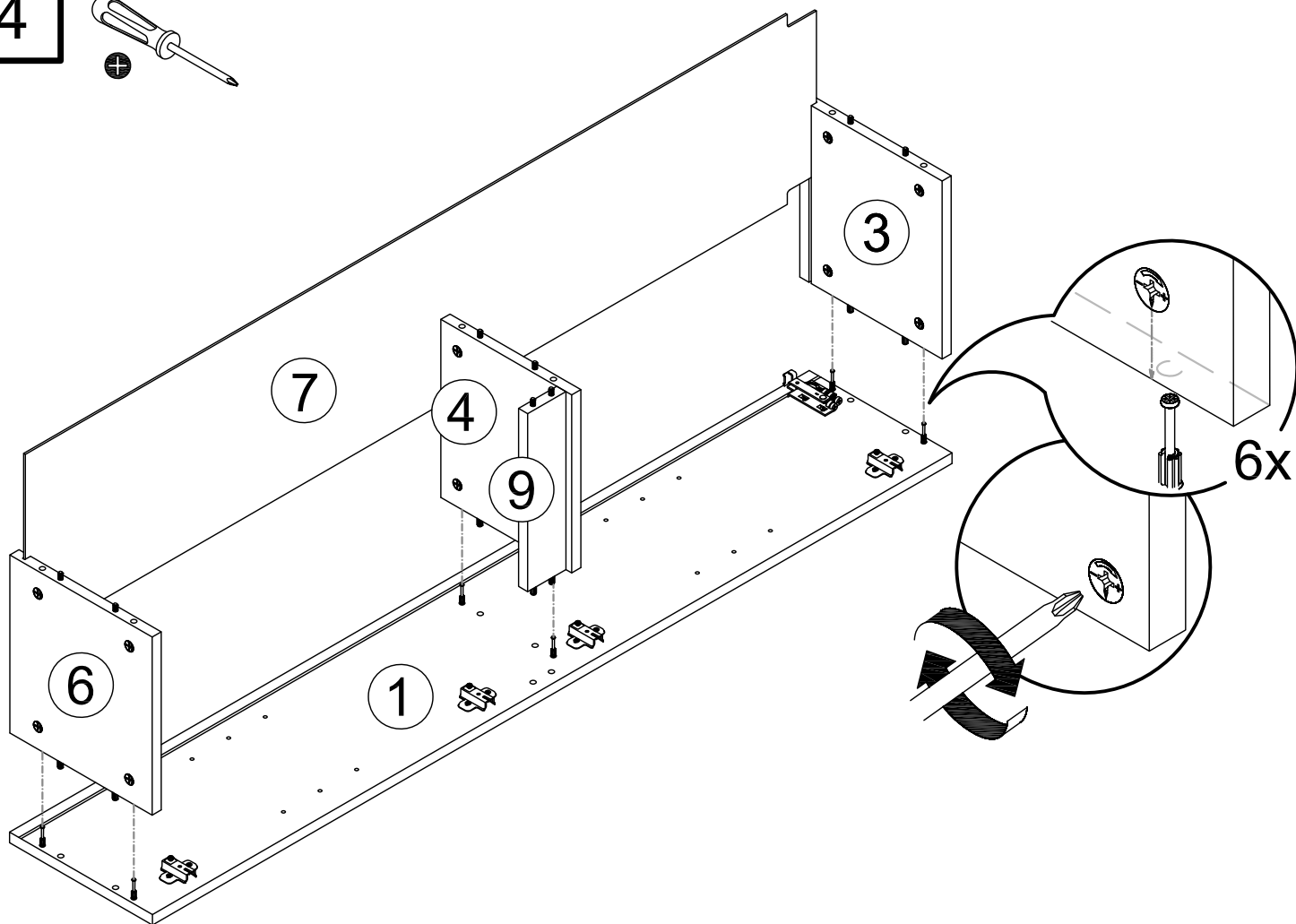
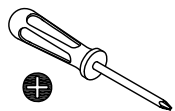

5

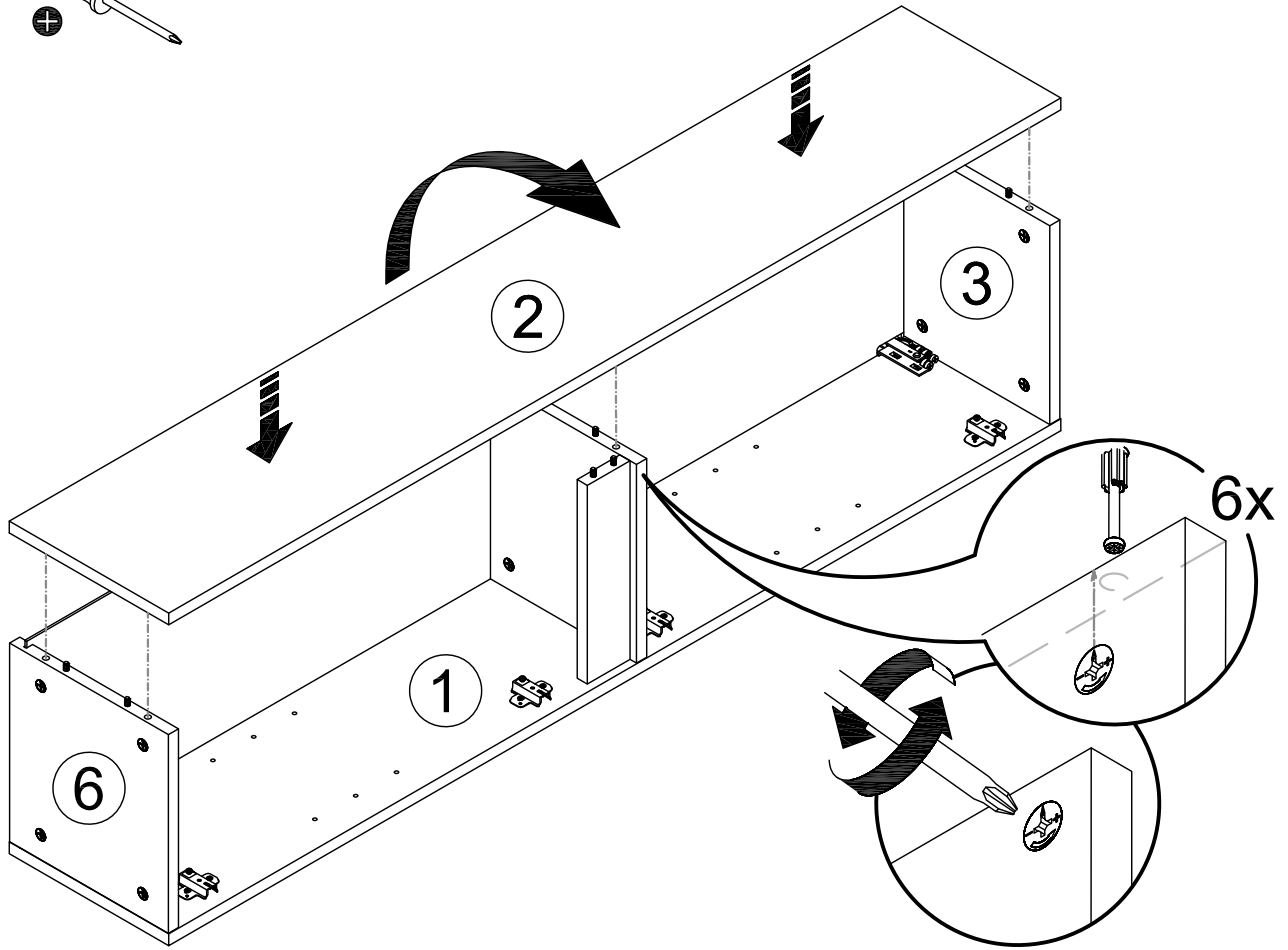
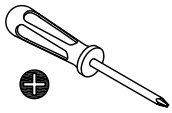

6

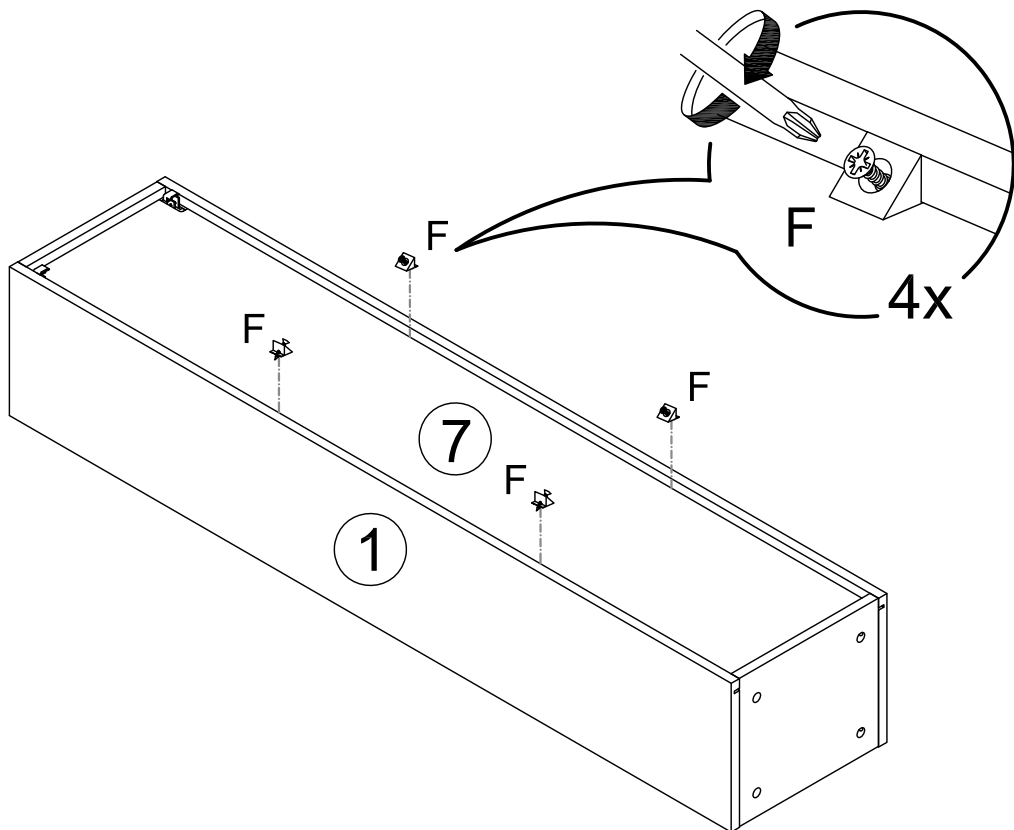
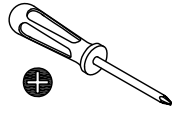

7



G x4

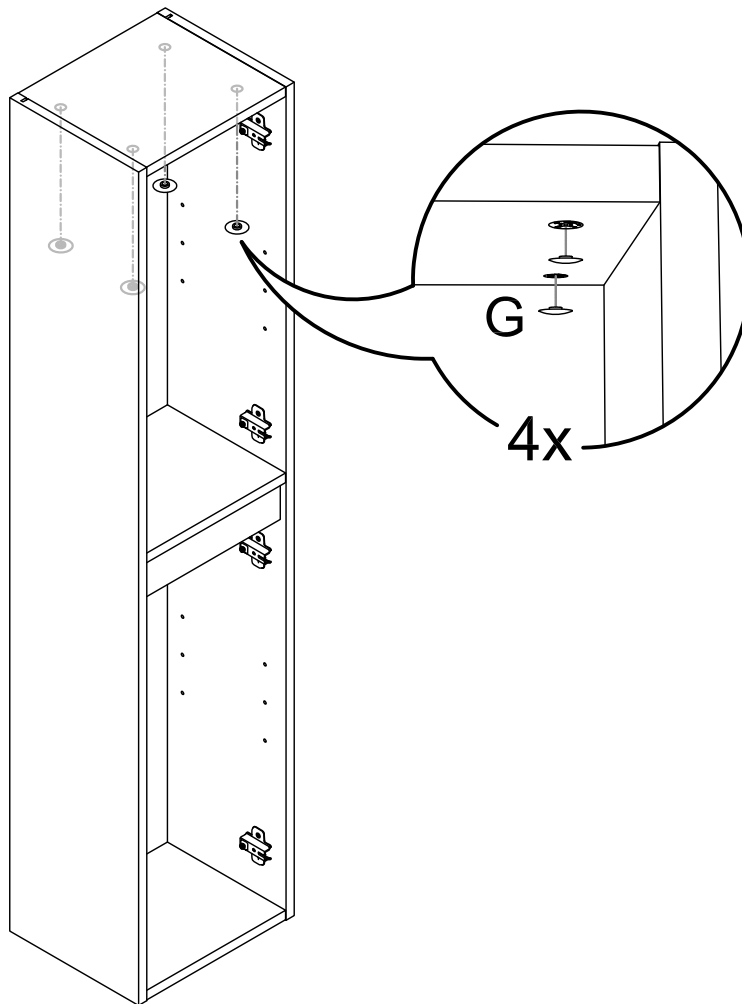

8



H x8

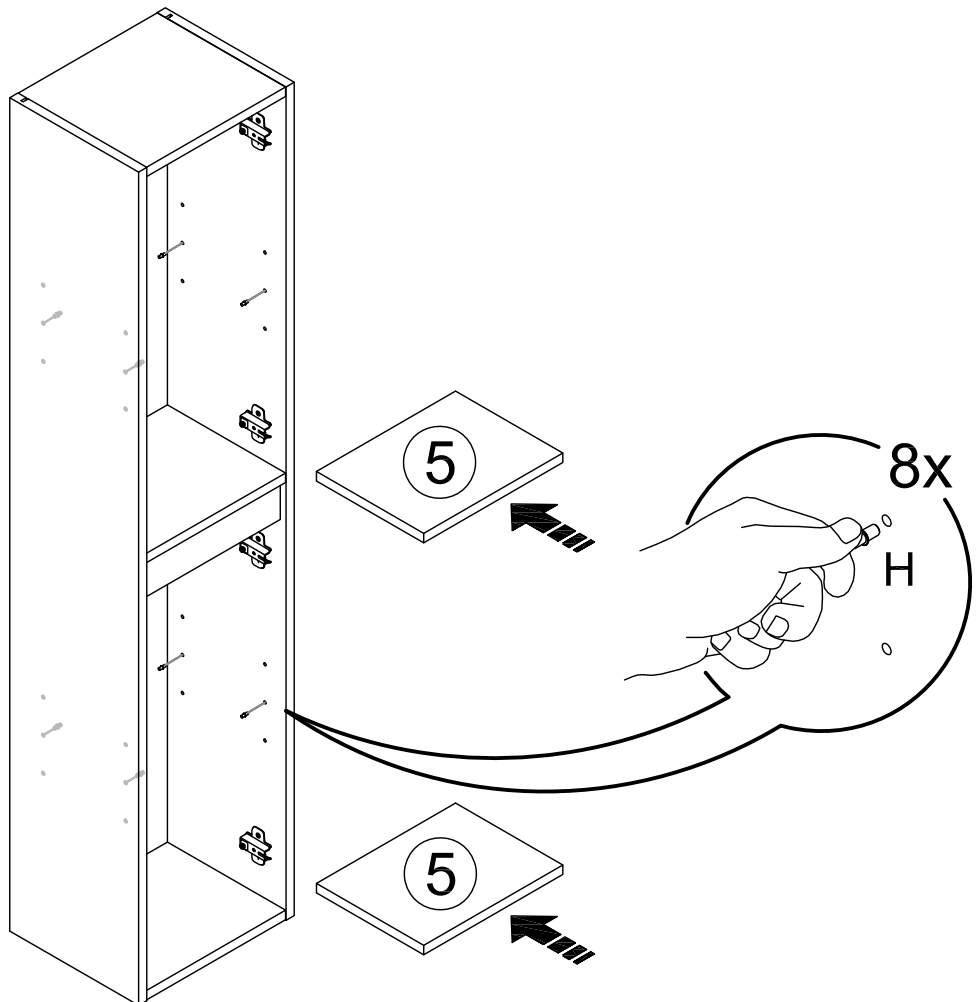

9

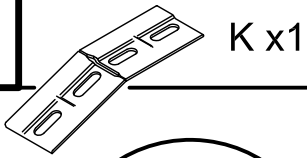

K x1

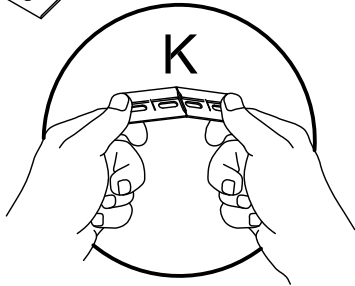
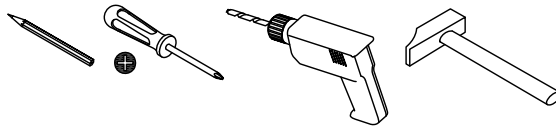

K

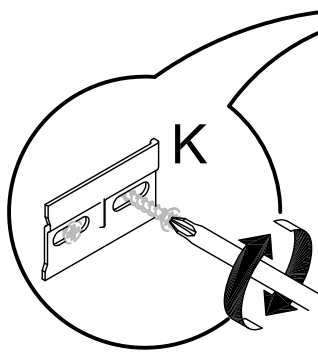
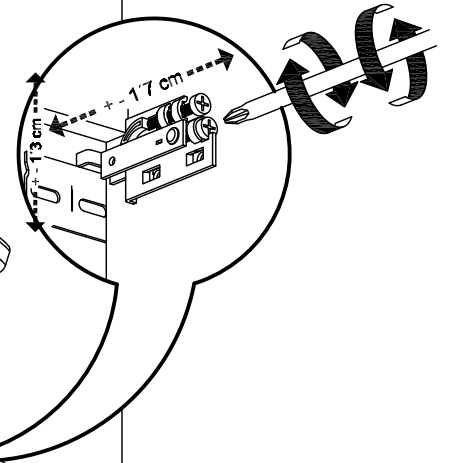

K

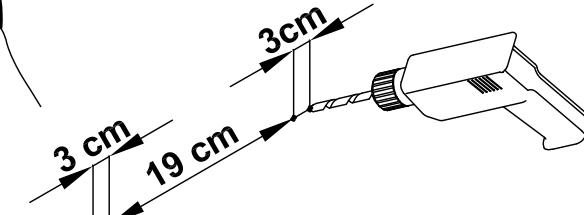

175 cm

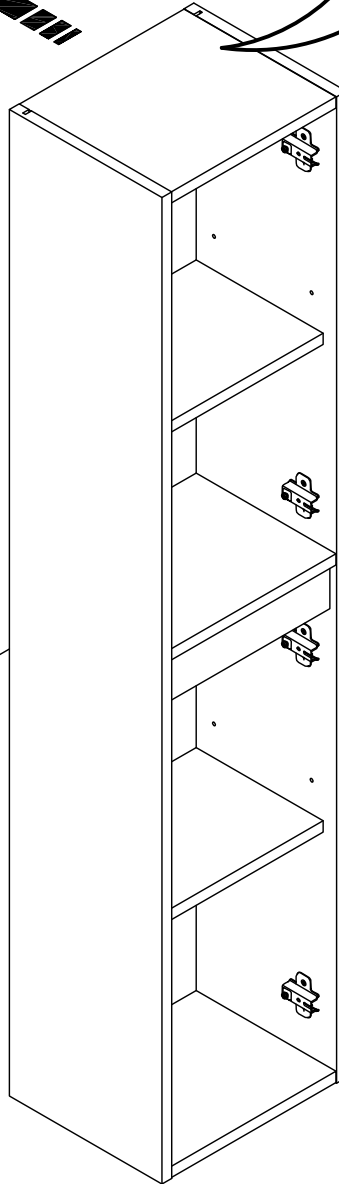

- FR - FIXATION MURALE OBLIGATORIE. Utilisez des vis et des chevilles adaptées à vos murs.
- ES - OBLIGATORIO FIJAR A LA PARED. Utilice los tornillos y tacos adecuados para su muro.
- EN - OBLIGATORY FIX ON THE WALL. Use screws and plugs suitable for your wall.
- PT - FIXAÇÃO OBRIGATÓRIA À PAREDE. Use os parafusos e buchas apropriados para sua parede.
- IT - OBLIGATORIO DA FISSARE ALLA PARETE. Utilizzare le viti e i tasselli appropriati per il muro.
- DE - ERFORDERLICH, UM DIE WAND ZU FIXIEREN. Verwenden Sie die entsprechenden Schrauben und Dübel für Ihre Wand.



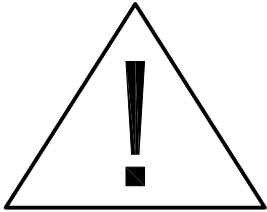

FR - Les vis et chevilles pour la fixation murale ne sont pas incluses car leur choix dépend du matériau du mur sur lequel est fixé le meuble.

EN - Screws and plugs for wall mounting are not included because their choice depends on the material of the wall on which is fixed the cabinet.



Il existe une grande diversité de types de murs ou cloisons, c'est la raison pour laquelle nous ne pouvons pas vous fournir le type exact de fixation. Voici quelques exemples de fixations conseillées pour:



LES MURS PLEINS

CHEVILLE NYLON  
"FISCHER"

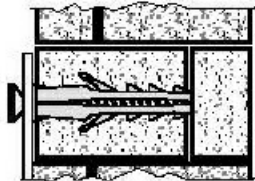
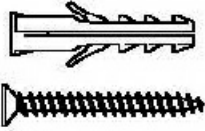

CHEVILLE D'ANCRAGE  
MÉTAL

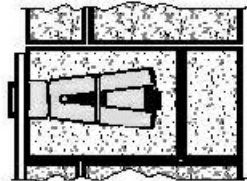
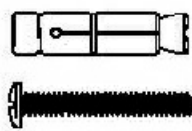

CHEVILLE D'ANCRAGE  
À AILETTES EN NYLON

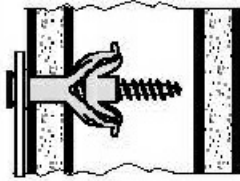
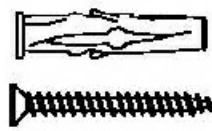

LES CLOISONS CREUSES

CHEVILLE MÉTALLIQUE  
À EXPANSION

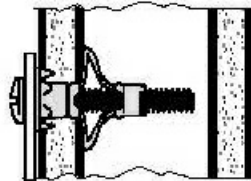
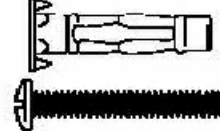

CHEVILLE  
"MOLLY"

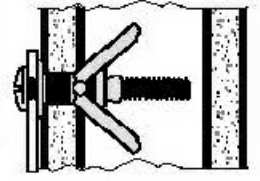
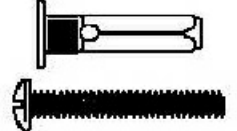

Utiliser une taille de forêt adaptée à la quincaillerie utilisée et au type de mur.



Due to the wide diversity of wall or partition types, we cannot provide you with suitable attachment fixtures. Here are some examples of attachment fixtures recommended for:



BLIND WALLS

"FISCHER"  
NYLON PLUG

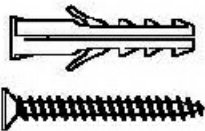

METAL  
WALL PLUG

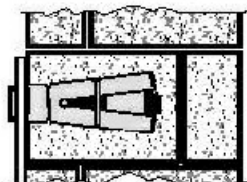
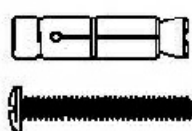

NYLON WINGED  
WALL PLUG

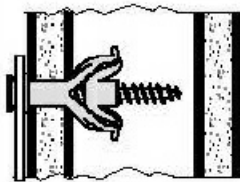
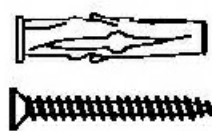

STUDDED WALLS  
METAL EXPANSION  
PLUG

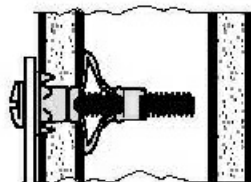
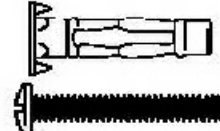

"MOLLY"  
PLUG

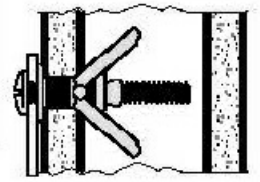
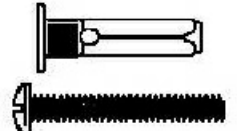

Use a drill bit that is compatible in size with the hardware used and the type of wall.

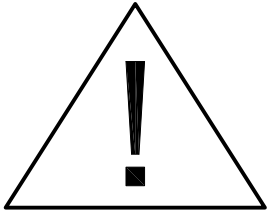

IT - Le viti e tasselli per il montaggio non sono compresi perché la sua elezione dipende dal materiale della parete nella quale si fissa il mobile.

DE - Die Schrauben und die Taco für die Versammlung werden nicht eingeschlossen, weil ihre Wahl vom Material der Mauer abhängt, in dem das Möbelstück merkt.



Esiste una gran varietà di tipi di muri o paratie e noi non siamo in grado di fornirvi il tipo esatto di fissaggio per ognuno di essi. Ecco qualche esempio di fissaggi consigliati per:



I MURI PIENI

TASSELLO NYLON  
"FISCHER"

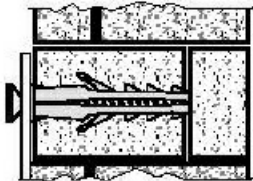
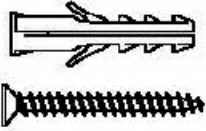

TASSELLO DI ANCORAGGIO  
IN METALLO

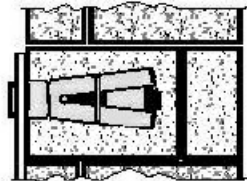
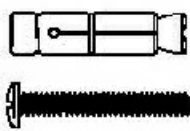

TASSELLO DI ANCORAGGIO AD  
ALETTE IN NYLON

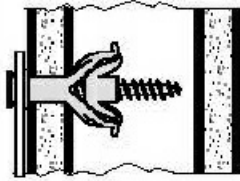
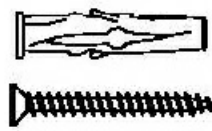

PARATIE CAVE

TASSELLO METALLICO  
AD ESPANSIONE

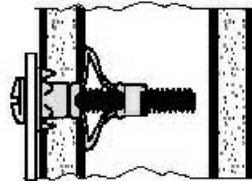
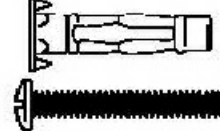

TASSELLO  
"MOLLY"

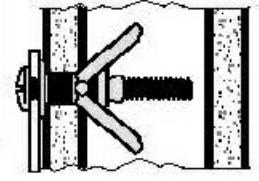
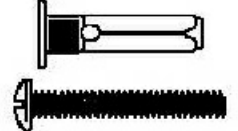

Utilizzare una punta di trapano adatta agli utensili utilizzati e al tipo di muro.



Es gibt eine Vielzahl verschiedener Arten von Mauern oder Zwischenwänden, und aus diesem Grunde können wir Ihnen den genau entsprechenden Befestigungstyp nicht bereitstellen. Nachfolgend einige Beispiele empfohlener Befestigungen für:



VOLLWÄNDE

NYLONDÜBEL  
"FISCHER"

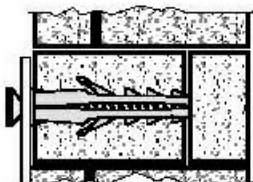
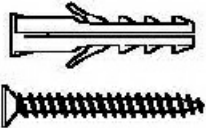

ANKERDÜBEL  
AUS METALL

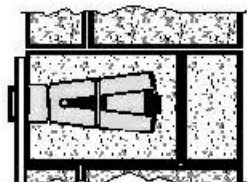
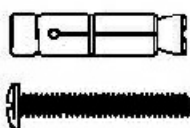

ANKERDÜBEL MIT  
NYLONFLÜGELN

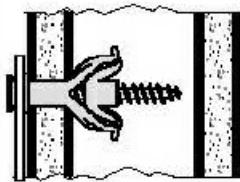
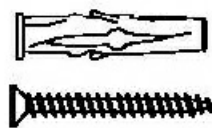

HOHLWÄNDE

SPREIZDÜBEL FÜR  
VERANKERUNG AUS METALL

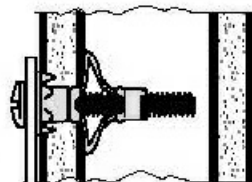
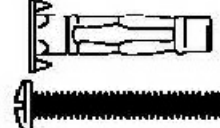

DÜBEL  
"MOLLY"

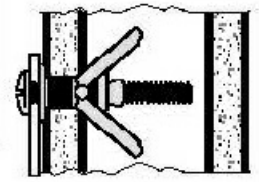
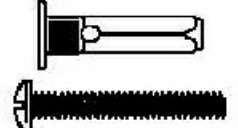

Bitte verwenden Sie eine für die Eisenwaren und den Wandtyp geeignete Bohrergroße.

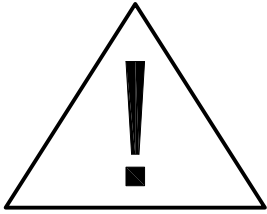

ES - Los tornillos y tacos para montaje en pared no están incluidos porque su elección depende del material de la pared en la que se fija el mueble.

PT - Os parafusos e buchas para montagem na parede não estão incluídos porque sua escolha depende do material da parede em que o móvel é fixo.



Existe una gran variedad de tipos de muros y paredes y no podemos proporcionarle el tipo exacto de fijación para cada uno. Aquí hay algunos ejemplos de fijaciones recomendadas para:



PARED MACIZA

TACO DE NYLON  
"FISCHER"

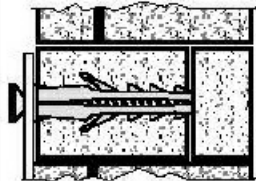
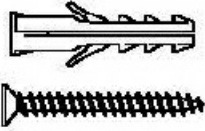

TACO DE ANCLAJE  
METÁLICO

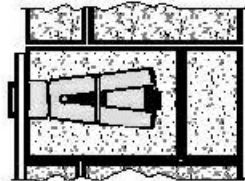
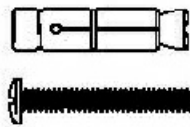

TACO DE ANCLAJE CON  
ALETAS DE NYLON

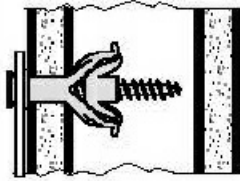
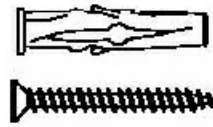

PARED HUECA  
TACO METÁLICO  
DE EXPANSIÓN

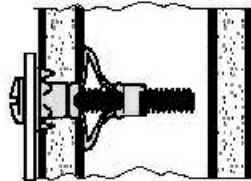
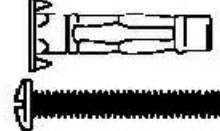

TACO  
"MOLLY"

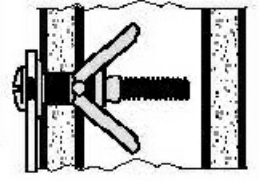
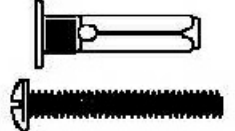

Use una broca adecuada para las herramientas utilizadas y el tipo de pared.



Existe uma grande variedade de tipos de paredes ou anteparas e não podemos fornecer o tipo exato de fixação para cada um. Aqui estão alguns exemplos de fixações recomendadas para:



PAREDES SÓLIDAS

BUCHA NYLON  
"FISCHER"

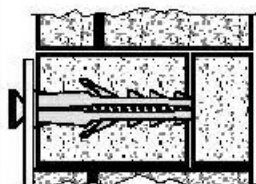
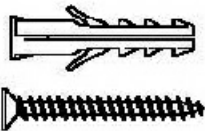

BUCHA ANCORAGEM  
METÁLICA

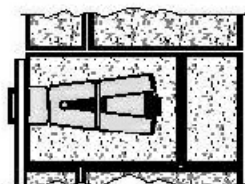
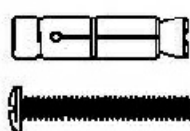

BUCHA ANCORAGEM  
COM ALETA NYLON

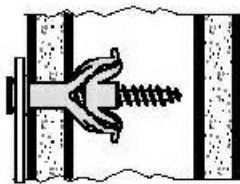
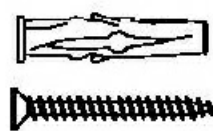

PAREDE OCA  
BUCHA DE EXPANSÃO  
METÁLICA

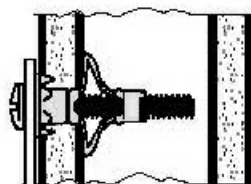
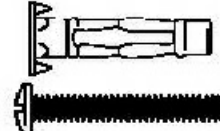

BUCHA  
"MOLLY"

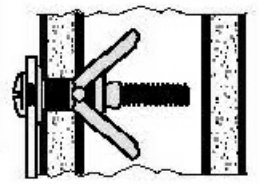
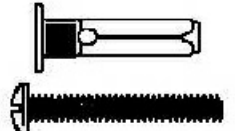

Use uma broca adequada para as ferramentas utilizadas e o tipo de parede.

10

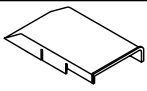

I x1

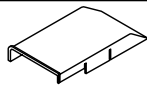

J x1

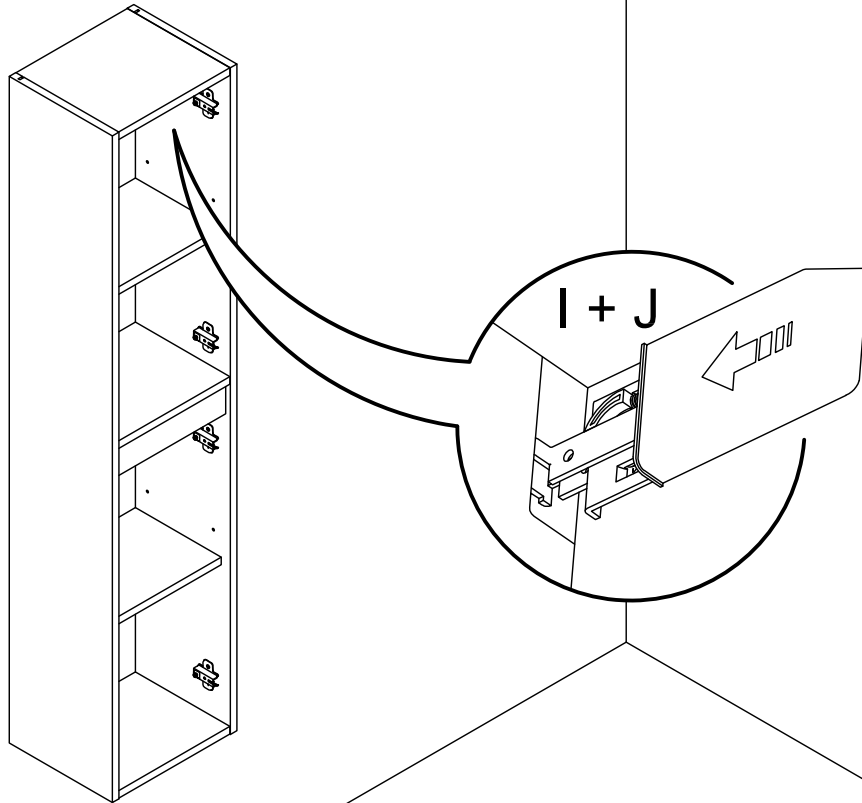

11

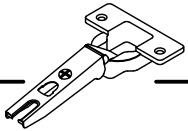

D x4



Ta x8

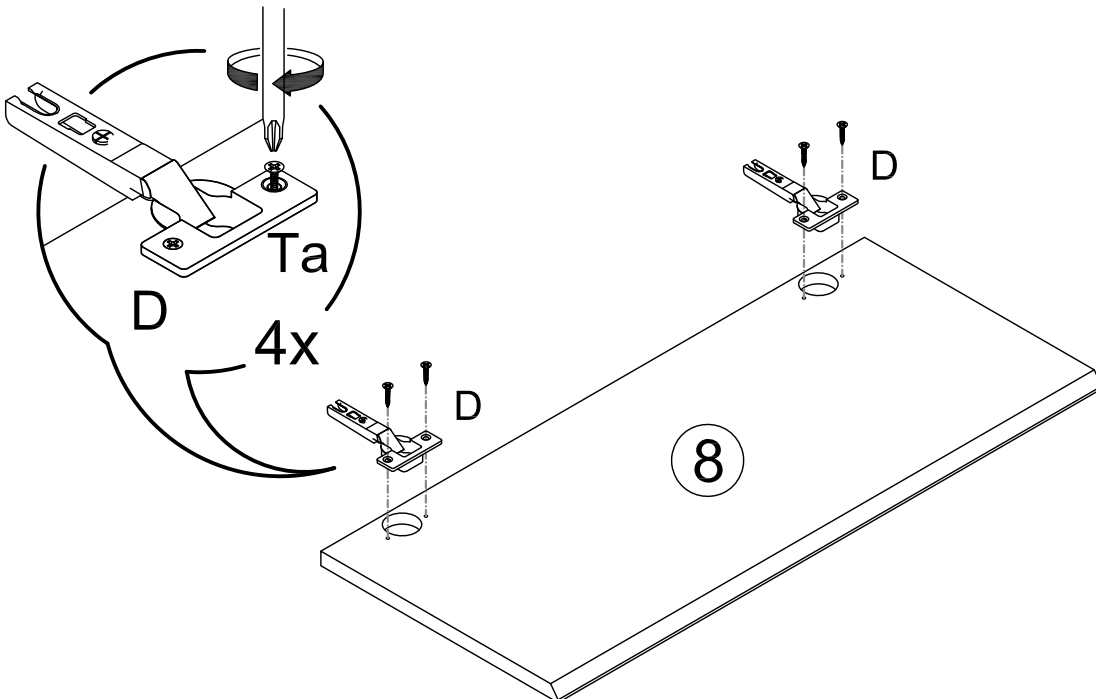
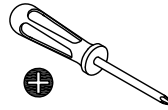

2x

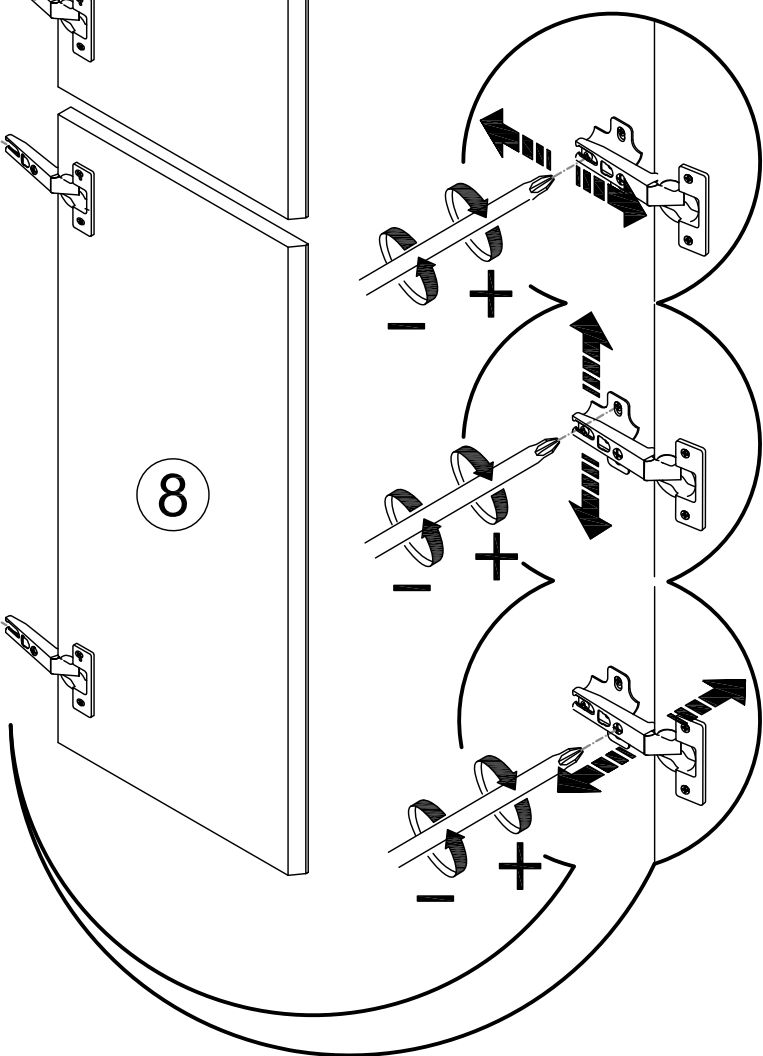
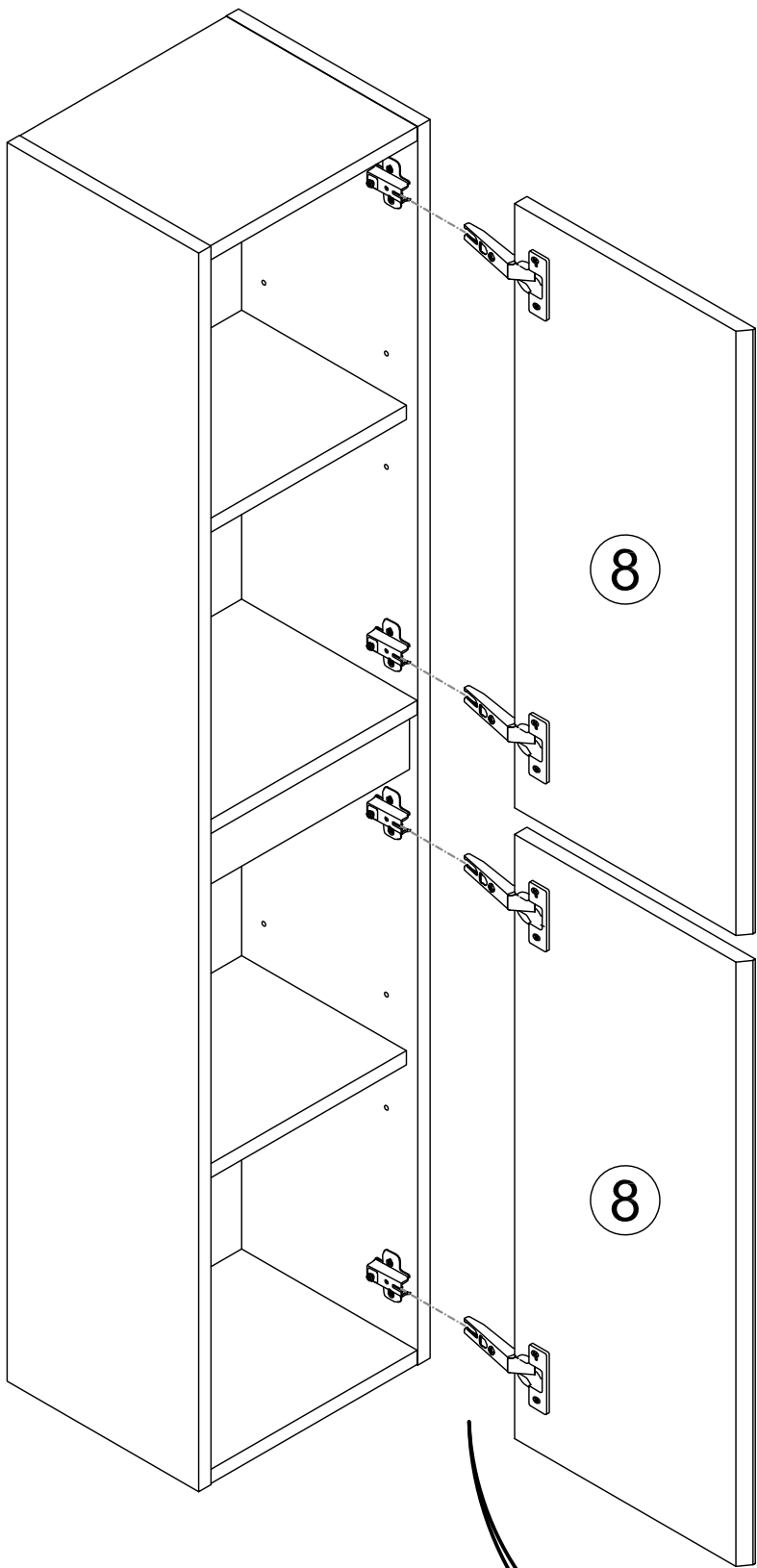
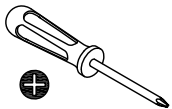

## FRANÇAIS - SUISSE

### CONSEILS DE MONTAGE:

- 1 > BIEN ÉTUDIER LA NOTICE DE MONTAGE.
- 2 > RÉPÉREZ LES PIÈCES CONSTITUANT VOTRE MEUBLE.
- 3 > REGROUPEZ ET CONTROLEZ LA QUINCAILLERIE.
- 4 > MUNISSEZ-VOUS DE L'OUTILLAGE NÉCESSAIRE.
- 5 > AMÉNAGEZ-VOUS UNE ZONE DE MONTAGE.
- 6 > PROCÉDEZ AU MONTAGE.



NE JAMAIS FORCER LES ASSEMBLAGES.  
RESSERREZ LES VIS APRÈS QUELQUES TEMPS D'USAGES.  
GARDER VOTRE NOTICE DE MONTAGE, SI UNE PIÈCE  
VENAIT A MANQUER, ELLE SERAIT LE PLUS CLAIR  
MOYEN DE COMMUNIQUER AVEC VOTRE MAGASIN.

### CONSEILS D'ENTRETIEN:

- 1 > DÉPOUSSIÉREZ SOIGNEUSEMENT.
- 2 > UTILISEZ UN CHIFFON SEC.



- NE JAMAIS UTILISER DE PRODUITS ABRASIFS: LAINE D'ACIER, SOLVANTS.
- NE PAS MOUILLER.

	PAPIER DÉCOR	SURFACES STRATIFIÉES	SURFACES LAQUÉES	BOIS VERNIS	TEXTILE CUIR
EAU SAVONNEUSE (SAVON NEUTRE)	○	○	○	○	○
EAU ADDITIONNÉE		○	○		
ENTRETIEN SPÉCIFIQUE FABRICANT					○

## DEUTSCH - SCHWEIZ

### MONTAGE ANLEITUNG:

- 1 > DIE MONTAGE ANLEITUNG SORGFÄLTIG DURCHLESEN.
- 2 > DIE EINZELTEILE DES MÖBELSTÜCKS ERMITTELN.
- 3 > DIE BESCHLÄGE ZUSAMMENLEGEN UND PRÜFEN.
- 4 > DAS NOTWENDIGE WERKZEUG ZURECHTLEGEN.
- 5 > EINEN MONTAGEBEREICH FREIMACHEN.
- 6 > DAS MÖBELSTÜCK ZUSAMMENBAUEN.



NIEMALS DIE VERBINDUNGEN ZU STARK ANZIEHEN.  
DIE SCHRAUBEN NACH EINIGER ZEIT DES GEBRAUCHS  
ERNEUT FESTZIEHEN. DIE MONTAGE ANLEITUNG GUT  
AUFBEWAHREN. SOLLTE EIN TEIL FEHLEN, IST SIE DAS  
BESTE VERSTÄNDIGUNGSMITTEL MIT IHREM GESCHÄFT.

### PFLEGEHINWEISE:

- 1 > SORGFÄLTIG ENTSTAUBEN.
- 2 > VERWENDEN SIE EIN TROCKENES TUCH.



- BENUTZEN SIE KEINE SCHEUERMITTEL WIE: STAHLWOLLE, LÖSUNGSMITTEL.
- KEIN WASSER VERWENDEN.

	DEKORPAPIER	OVERFLÄCHE LAMINAT	OVERFLÄCHE LACK	LACKIERTEM HOLZ	TEXTIL LEDER
SEIFENLAUGE (NEUTRAL SEIFE)	○	○	○	○	○
WASSER MIT HAUSHALTSREINIGER		○	○		
PRODUZENT SPEZIFISCHER UNTERHALI					○

## ITALIANO - SVIZZERA

### CONSIGLI DI MONTAGGIO:

- 1 > STUDIARE BENE LE ISTRUZIONI DI MONTAGGIO.
- 2 > RICONOSCERE I PEZZI CHE COSTITUISCONO IL MOBILE.
- 3 > RAGGRUPPARE E CONTROLLARE LA FERRAMENTA.
- 4 > MUNIRSI DEGLI UTENSILI NECESSARI.
- 5 > PREPARARE UNA ZONA DI MONTAGGIO.
- 6 > PROCEDERE AL MONTAGGIO.



NON FORZARE MAI GLI ASSEMBLAGGI.  
RISTRINGERE LE VITI DOPO UN PERIODO D'USO.  
CONSERVARE QUESTE ISTRUZIONI DI MONTAGGIO, SE  
UN PEZZO VENISSE A MANCARE SAREBBE IL MIGLIORE  
MEZZO DI COMUNICAZIONE CON IL RIVENDITORE.

### CONSIGLI PER LA MANUTENZIONE:

- 1 > SPOLVERATE ACCURATAMENTE.
- 2 > USARE UN PANNINO ASCIUTTO.



- NON UTILIZZARE MAI PRODOTTI ABRASIVI: LANA DI ACCIAIO, SOLVENTI.
- NON BAGNARE.

	CARTA	SUPERFICIE STRATIFICATE	SUPERFICIE LACCATE	LACCATE EGNO VERNICIATO	TESSILE CUOTO
ACQUA CON SAPONE (SAPONE NEUTRO)	○	○	○	○	○
ACQUA CON DETERSIVO		○	○		
MANUTENZIONE SPECIFICA PRODUTTORE					○

## ENGLISH

### ASSEMBLY ADVICE:

- 1 > CAREFULLY READ THE ASSEMBLY INSTRUCTION.
- 2 > IDENTIFY THE COMPONENTS OF THE FURNITURE.
- 3 > GROUP AND CHECK THE HARDWARE.
- 4 > USE THE REQUIRED TOOLS.
- 5 > CREATE AN ASSEMBLY ZONE.
- 6 > MAKE THE ASSEMBLY.



NEVER FORCE THE CONNECTIONS.  
RE-TIGHTEN THE SCREWS AFTER FEW DAYS.  
PLEASE RETAIN THE AI LEAFLET FOR FUTURE REFERENCE,  
THE AI CONTAINS INFORMATION WHEN CLAIMING  
FOR MISSING PARTS.

### CLEANING ADVICE:

- 1 > CAREFULLY REMOVE THE DUST.
- 2 > USE A SOFT AND CLEAN CLOTH.



- NEVER USE ABRASIVE PRODUCTS OR SOLVENTS.
- DO NOT USE APPLY EXCESSIVE PRESSURE WHEN USING THE DAMP CLOTH.

	PAPER DECOR	LAMINATED SURFACES	LACQUERED SURFACES	VARNISHED WOOD	LEATHER TEXTILE
SOAPY WATER (NEUTRAL SOAP)	<input type="radio"/>	<input type="radio"/>	<input type="radio"/>	<input type="radio"/>	<input type="radio"/>
WATER WITH DETERGENT		<input type="radio"/>	<input type="radio"/>		
SPECIFIC SUPPLIER CLEANING					<input type="radio"/>

## ESPAÑOL

### CONSEJOS PARA EL MONTAJE:

- 1 > ESTUDIE ATENTAMENTE EL MANUAL DE MONTAJE.
- 2 > LOCALICE LA PIEZAS QUE CONSTITUYEN EL MUEBLE.
- 3 > REUNA Y CONTROLE EL HERRAJE.
- 4 > EQUIPESE DE LAS HERRAMIENTAS NECESARIAS.
- 5 > PREPARE UNA ZONA DE MONTAJE.
- 6 > REALICE EL MONTAJE.



NO FUERCE NUNCA LAS UNIONES. APRIETE LOS TORNILLOS DESPUÉS DE CIERTO TIEMPO DE UTILIZACIÓN. CONSERVE SU MANUAL DE MONTAJE, SI FALTARA UNA PIEZA SERÍA LA MANERA MÁS FÁCIL DE COMUNICAR CON LA TIENDA.

### CONSEJOS PARA EL MANTENIMIENTO:

- 1 > QUITAR EL POLVO CUIDADOSAMENTE.
- 2 > UTILICE UN PAÑO LIMPIO Y SECO.



- NO USE NUNCA PRODUCTOS ABRASIVOS COMO: LANA DE ACERO O DISOLVENTES.
- NO MOJAR.

	PAPEL DECORATIVO	SUPERFICIE LAMINADA	SUPERFICIE LACADA	MADERA BARNIZADA	TEXTIL CUERO
AGUA Y JABÓN (JABÓN NEUTRO)	<input type="radio"/>	<input type="radio"/>	<input type="radio"/>	<input type="radio"/>	<input type="radio"/>
AGUA CON DETERGENTE		<input type="radio"/>	<input type="radio"/>		
MANTENIMIENTO ESPECÍFICO DEL FABRICANTE					<input type="radio"/>

## NEDERLANDS

### MONTAGETIPS:

- 1 > LEES DE MONTAGE-INSTRUCTIES ZORGVULDIG DOOR.
- 2 > IDENTIFICEER ALLE ONDERDELEN VAN UW MEUBEL.
- 3 > VERZAMEL EN CONTROLEER HET INZERWAREN.
- 4 > NEEM HET BENODIGDE GEREEDSCHAP.
- 5 > MAAK EEN ZONE VRIJ VOOR DE MONTAGE.
- 6 > GA VERDER MET DE MONTAGE.



FORCEER NOOIT DE VERBINDINGEN. DRAAI DE SCHROEVEN OPNIEUW VAST NA EEN PAAR DAGEN. BEWAAR UW MONTAGE-INSTRUCTIES. ZIJN DE DUIDELJKSTE MIDDEL OM MET DE WINKEL TE COMMUNICEREN WANNEER EEN ONDERDEEL ONTBREEKT.

### ODERHOUDSTIPS:

- 1 > ZORGVULDIG AFSTOFFEN.
- 2 > GEBRUIK EEN DROGE DOEK.



- GEBRUIK GEEN SCHUREND PRODUCT: STAAWOL, OPLOSMIDDELEN.
- MAAK HET NIET NAT.

	DECOR PAPIER	GELAMINEERDE OPPERVLAKTES	GELAKTE OPPERVLAKTES	HOUT VERNIS	TEXTIEL LEDER
ZEEPWATER	<input type="radio"/>	<input type="radio"/>	<input type="radio"/>	<input type="radio"/>	<input type="radio"/>
WATER MET WASMIDDEL		<input type="radio"/>	<input type="radio"/>		
SPECIEFIEK ONDERHOUD FABRIKANT					<input type="radio"/>

# PORTUGUÊS

## CONSELHOS DE MOTAGEM:

- 1 > ESTUDE BEM AS INSTRUÇÕES DE MONTAGEM.
- 2 > REUNA AS PEÇAS QUE CONSTITUEM O SEU MÓVEL.
- 3 > REAGRUPE AS FERRAGENS.
- 4 > EQUIPE-SE COM AS FERRAMENTAS NECESSÁRIAS.
- 5 > PREPARE UMA ÁREA PARA A MONTAGEM.
- 6 > INICIE A MONTAGEM.

## CONSELHOS PARA A MANUTENÇÃO:

- 1 > ELIMINAR BEM O PÓ.
- 2 > USAR PANO SECO.



- NUNCA UTILIZAR PRODUTOS ABRASIVOS: LÃ DE AÇO OU SOLVENTES.
- NÃO MOLHAR.

  
NUNCA FORÇAR OS ENCAIXES.  
REAPERTAR OS PARAFUSOS APÓS UM TEMPO DE UTILIZAÇÃO. GUARDAR AS INSTRUÇÕES DE MONTAGEM. CASO FALTE ALGUMA PEÇA, O MAIS ACONSELHÁVEL É CONTATAR O REVENDEDOR.

	ACABAMENTO IMITAÇÃO	SUPERFÍCIES ESTRATIFICADAS	SUPERFÍCIES LACADAS	MADEIRA ENVERNIZADA	TEXTIS PELES
ÁGUA COM SABÃO (JSABÃO NEUTRO)	○	○	○	○	○
ÁGUA COM DETERGENTE		○	○		
INSTRUÇÕES ESPECÍFICAS DO FABRICANTE					○

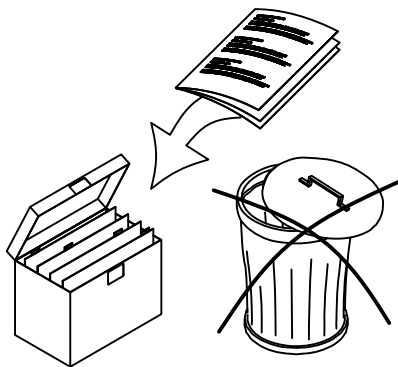

FR

**Donnez ou recyclez vos meubles.**



Association

ou



Magasin

ou



Déchèterie

<https://quefairedemesdechets.fr>