

53090/\*\*/P7

53092/\*\*/P7

53093/\*\*/P7



Gebruiksaanwijzing

Notice d'emploi

Benutzerhandbuch

User manual

Manual de usuario



53090/\*\*/P7



53092/\*\*/P7



53093/\*\*/P7

# PHILIPS

Incl.



Excl.

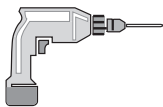

[www.meethue.com/getstarted](http://www.meethue.com/getstarted)

2



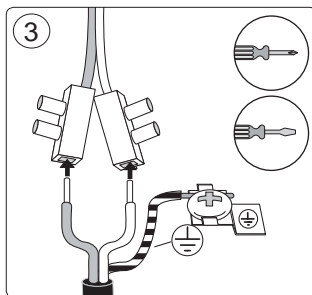
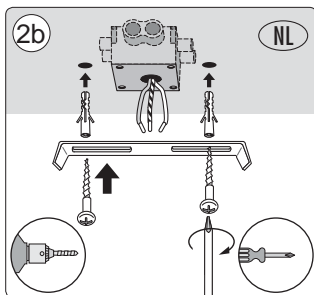
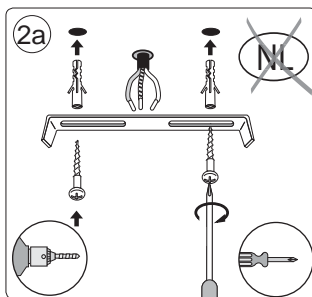
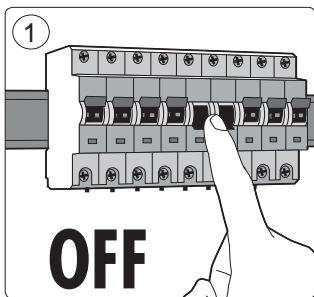

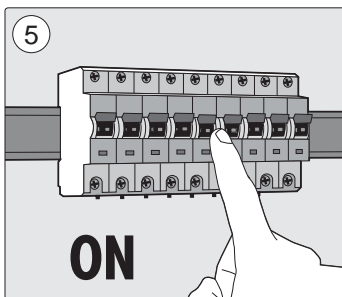
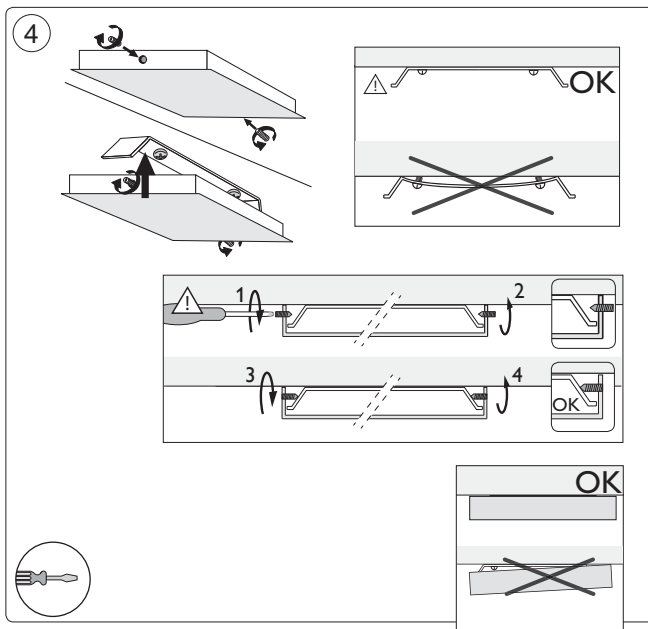

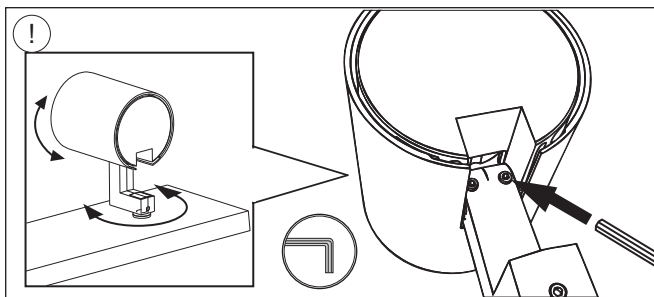



Philips Lighting Contact Centre  
Int. Business Reply Service  
I.B.R.S. / C.C.R.I. Numéro 10461  
5600 VB Eindhoven  
Pays-Bas / The Netherlands

[www.meethue.com/getstarted](http://www.meethue.com/getstarted)  
[www.philips.com/homelighting](http://www.philips.com/homelighting)  
☎ +800 7445 4775

4404.029.05301  
Last update: 07/07/16