

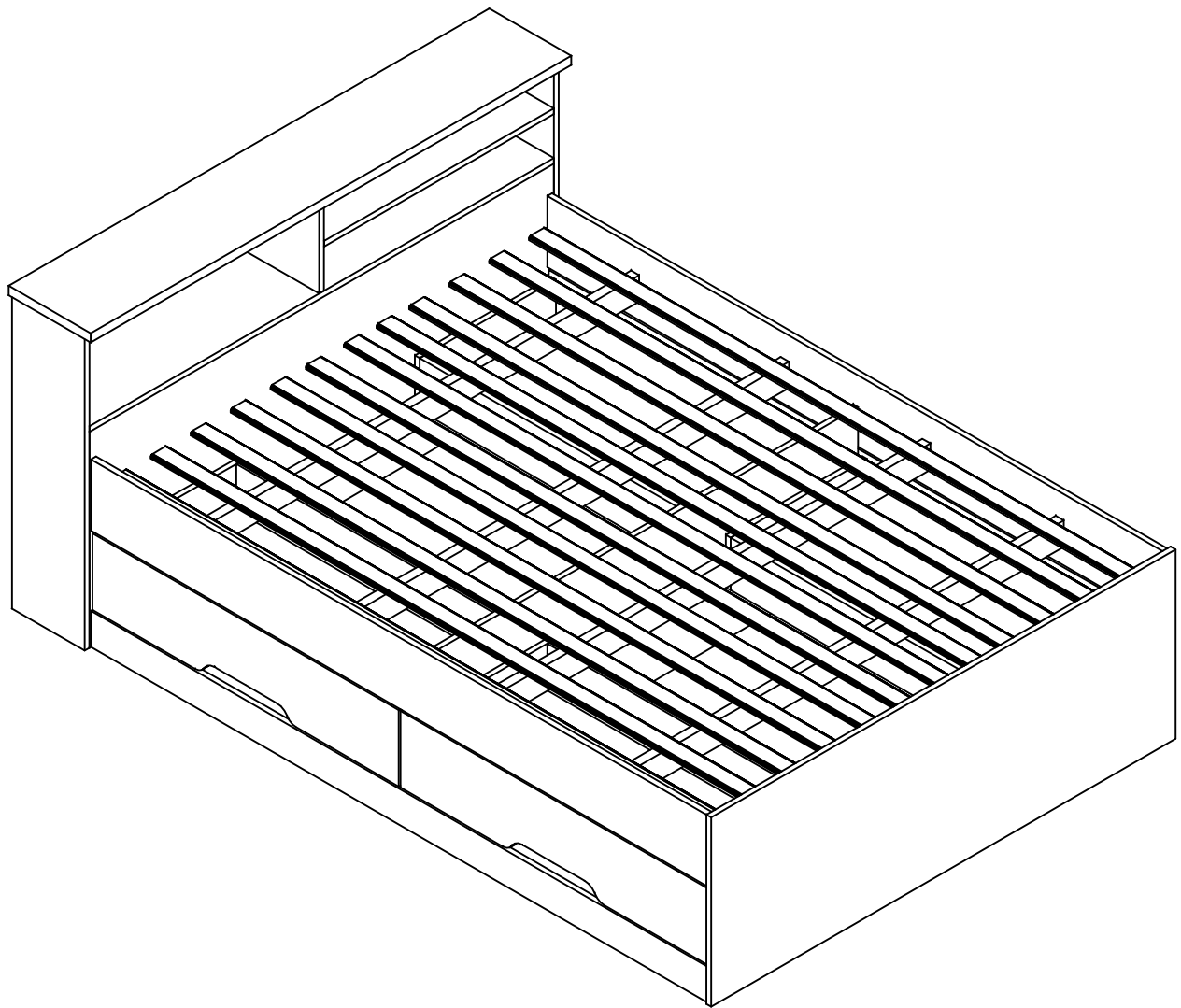

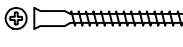

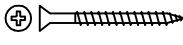





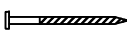

Assembly Instructions

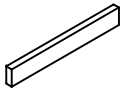
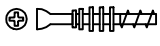
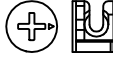
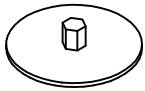
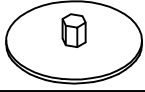

**03 month warranty against
manufacturing defects**

Lista de peças						
Assistance Code	Description	Qty.	Lenght. (mm)	Wide. (mm)	Tickness. (mm)	Box/ volume
01	Top Head	1	1480	253	25	A
02	Foot Board	1	1430	505	15	A
03	Bed Side	2	1900	190	15	B
04	Bed Footer	2	1900	96	15	B
05	Bed Partition	1	1390	416	15	A
06	Partition	1	250	224	15	A
07	Lower Shelf	1	707	224	15	A
08	Longer Shelf	1	1430	224	15	A
09	Side Right Bedside	1	841	224	15	C
10	Side Right Bedside	1	841	224	15	C
11	Bedside	1	1430	576	15	A
12	Right-Drawer Front	2	943	204	15	B
13	Left-Drawer Front	2	943	204	15	B
14	Side Drawer	8	420	140	15	C
15	Drawer Bedside	4	888	125	15	C
16	Bottom of Drawer	4	888	420	15	C
17	Back	1	1450	270	3	A

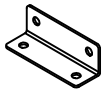
Iron Parts			
Assistance Code	Description	Qty.	
A 3682	 Philips screw 5,0x50	23	
B 226	 Boring screw 4,0x40 bichromatic	36	
C 4214	 Boring screw 3,5x14 countersunk head	126	
D 1802	 Peg 6x30mm	74	
E 107	 Nail 10 x 10	70	
F 149	 Nail 13 x 15	16	
G 1901	 Shoe black deslizadora	16	
H 12348	 Bed transom bracket	8	

I	2369		bed ballast 187x5x1	12
J	347		Dish 139x7x2.2	4
K	30945		Minifix (screw)	2
L	30950		Minifix (drum)	2
M	2347		Cover White minifix	2
M	14855		Cover minifix Carvalle	2
N	41		white glue tube (10g)	1
O	899		Metal bracket	2
P	85		"L" metal	19
Q	5288		Slide 400mm (metal)	4



