

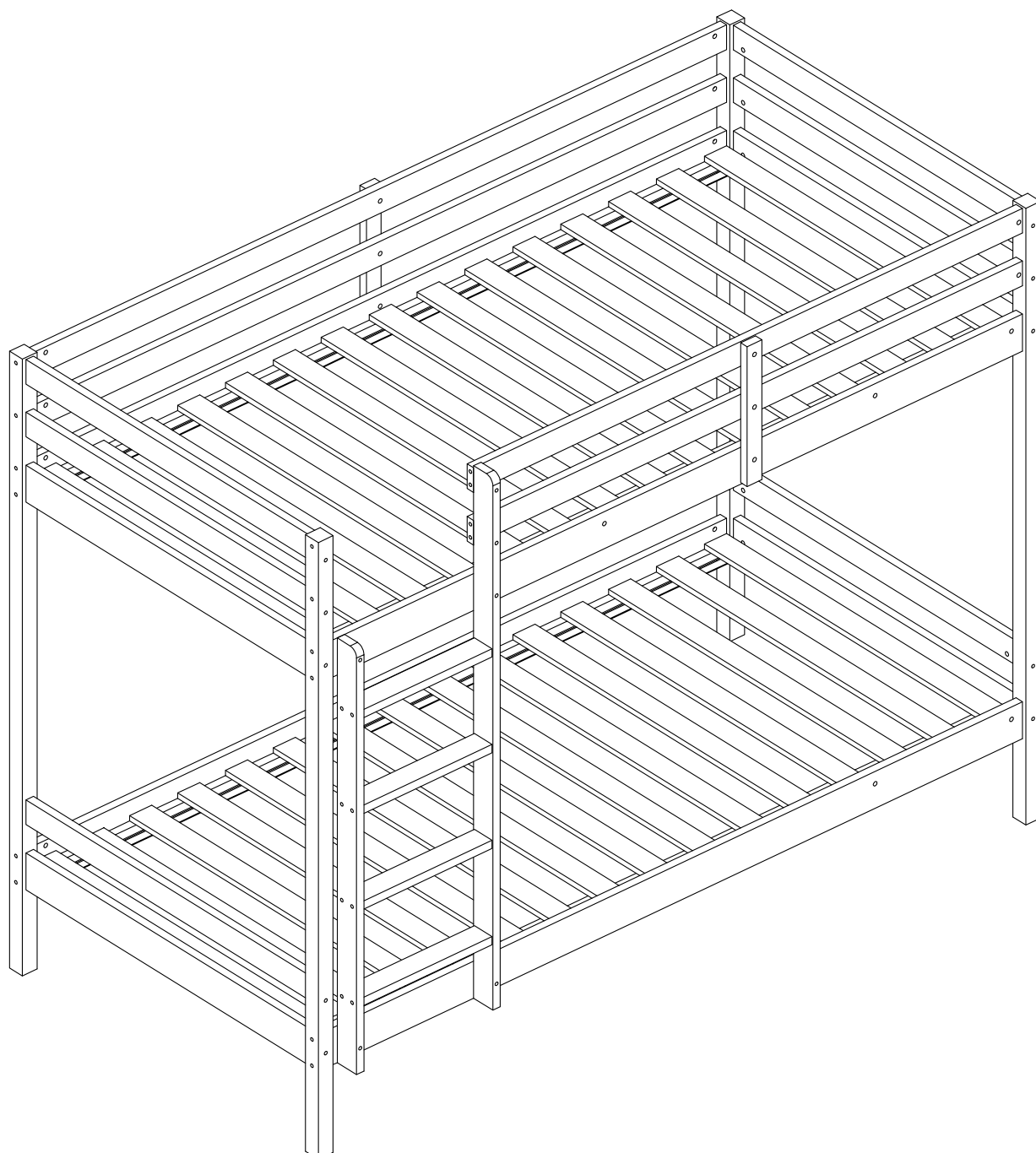

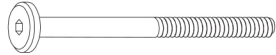













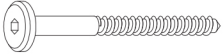







# Lionel

1548\_131128



# 1548\_131128

A		M6*80MM	X42PC	1/2
B			X42PC	1/2
C		M6*70MM	X6PC	1/2
D		M6*25MM	X6PC	1/2
E		φ8X20MM	X12PC	1/2
F			X2PC	1/2
G		φ8*30MM	X42PC	1/2
H		φ4*30MM	X60PC	1/2
I		φ6*70MM	X16PC	1/2

1		1500*40*40	X2PC	1/2
2		1500*40*40	X2PC	1/2
3		880*90*20	X4PC	1/2
4		880*60*20	X6PC	1/2
5		1880*90*20	X1PC	1/2
6		1880*90*20	X1PC	1/2
7		1880*90*20	X1PC	1/2
8		1880*90*20	X1PC	1/2
9		1880*60*20	X2PC	1/2
10		1490*60*20	X2PC	1/2
11		340*40*20	X2PC	1/2
12		1293*60*20	X1PC	1/2
13		1033*60*20	X1PC	1/2
14		350*55*20	X4PC	1/2
15		899*60*13	X30PC	2/2

FR : SAV/INFORMATION /VIDEO/CONTACT

EN: AFTER-SALES SERVICE/INFORMATION/VIDEO/CONTACT

DE : REPARATUR-SERVICE UND ERSATZTEILE //INFORMATIONEN /VIDEO/KONTAKT

ES: SERVICIO POST-VENTA/INFORMACI N/VIDEO/CONTACTO

IT: SERVIZIO ASSISTENZA/INFORMAZIONI/VIDEO/CONTATTO

PT: SERVIÇO P S-VENDA/INFORMAÇÕES/VIDEO/CONTATO

PL: SERWIS TECHNICZNY//INFORMACJE/WIDEO/KONTAKT

NE: AFTER SALES SERVICE//INFORMATIE/VIDEO/CONTACT

HE: סע רשקתל/ואדיווה/ עדימ/תוריקמו תוריש רחאל

**SAV.HABITATETJARDIN.COM**

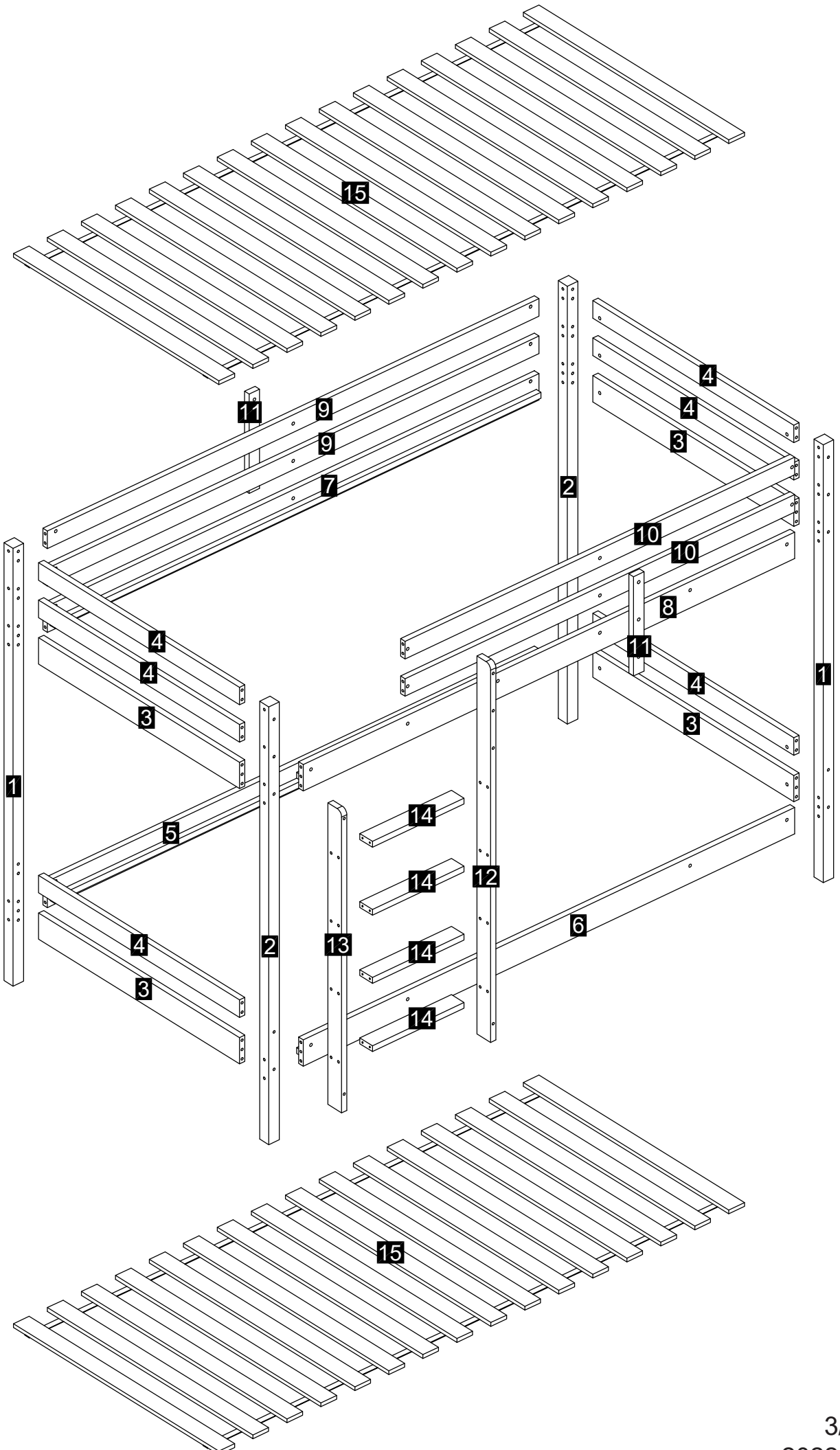

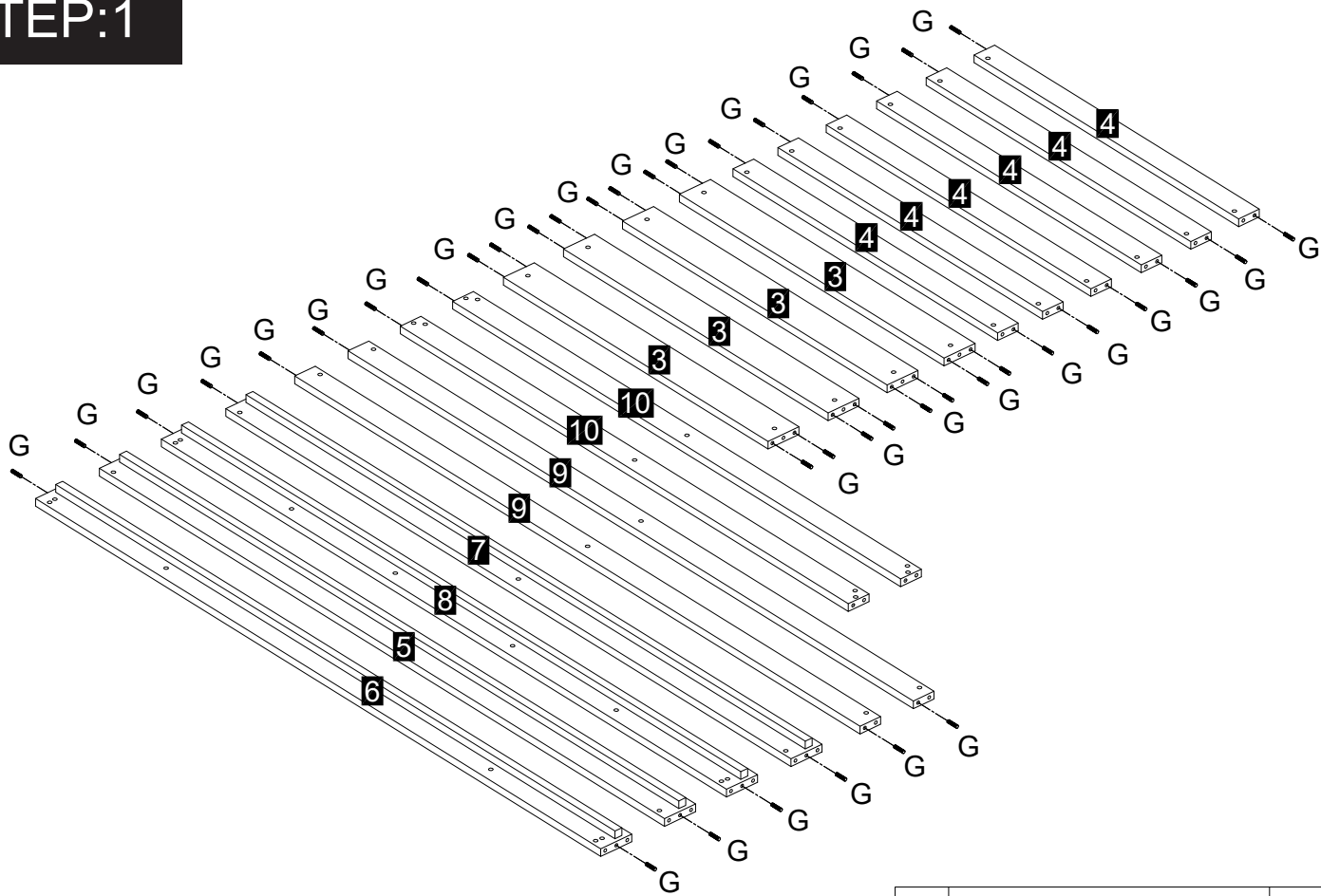

# STEP:1



G		Φ8*30mm	42
---	---	---------	----

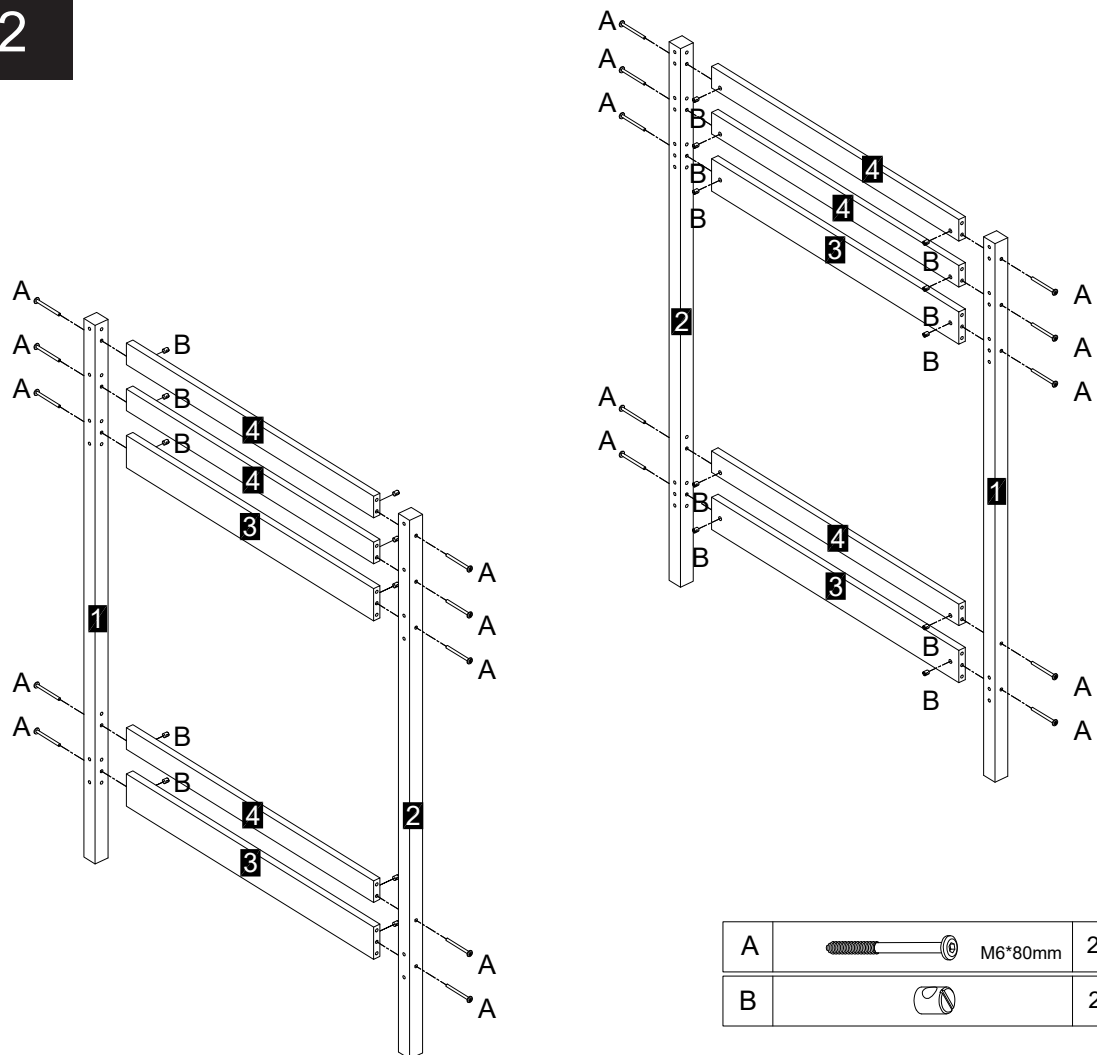

# STEP:2

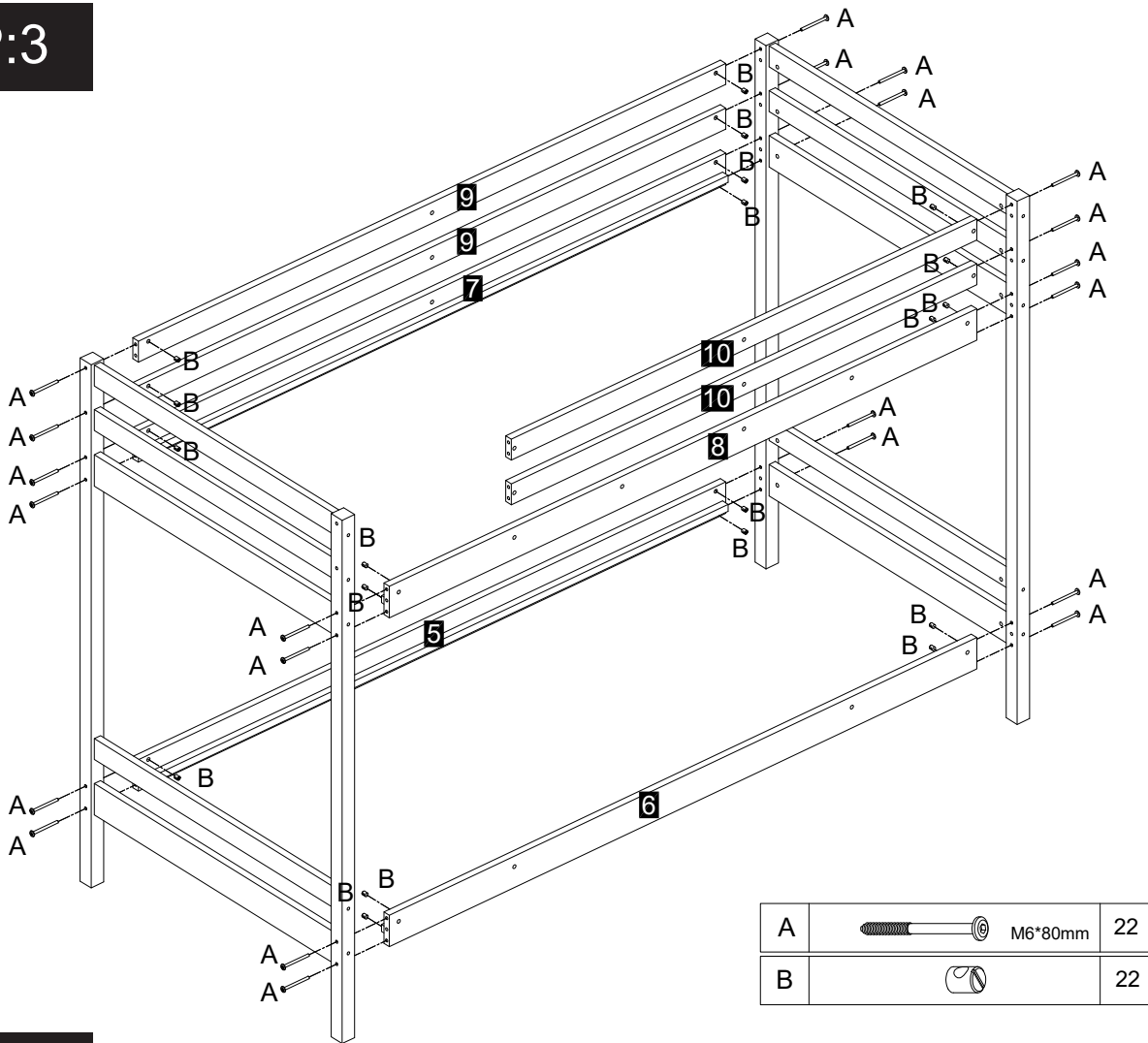

A		M6*80mm	20
B			20

# STEP:3



A		M6*80mm	22
B			22

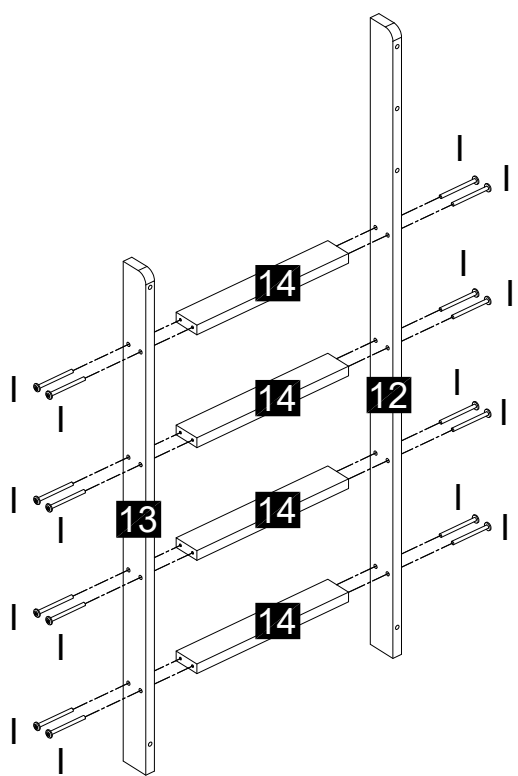

# STEP:4

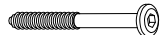

I		Φ6*70mm	16
---	--	---------	----

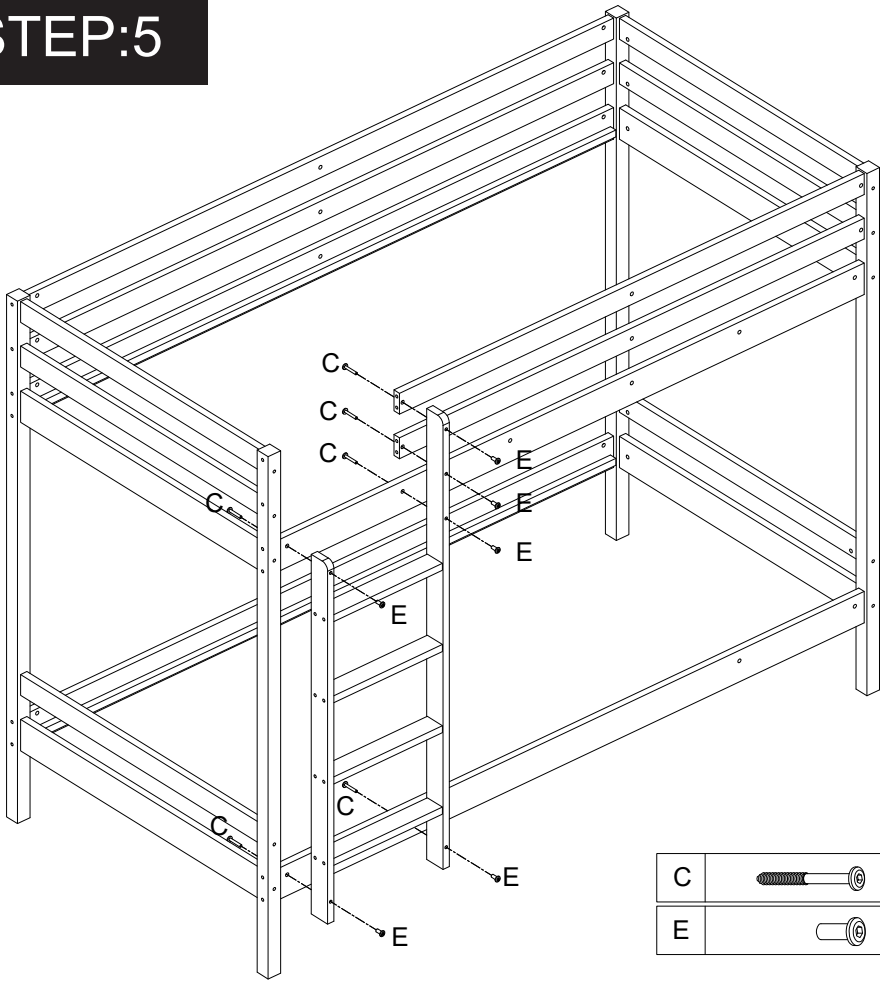

# STEP:5

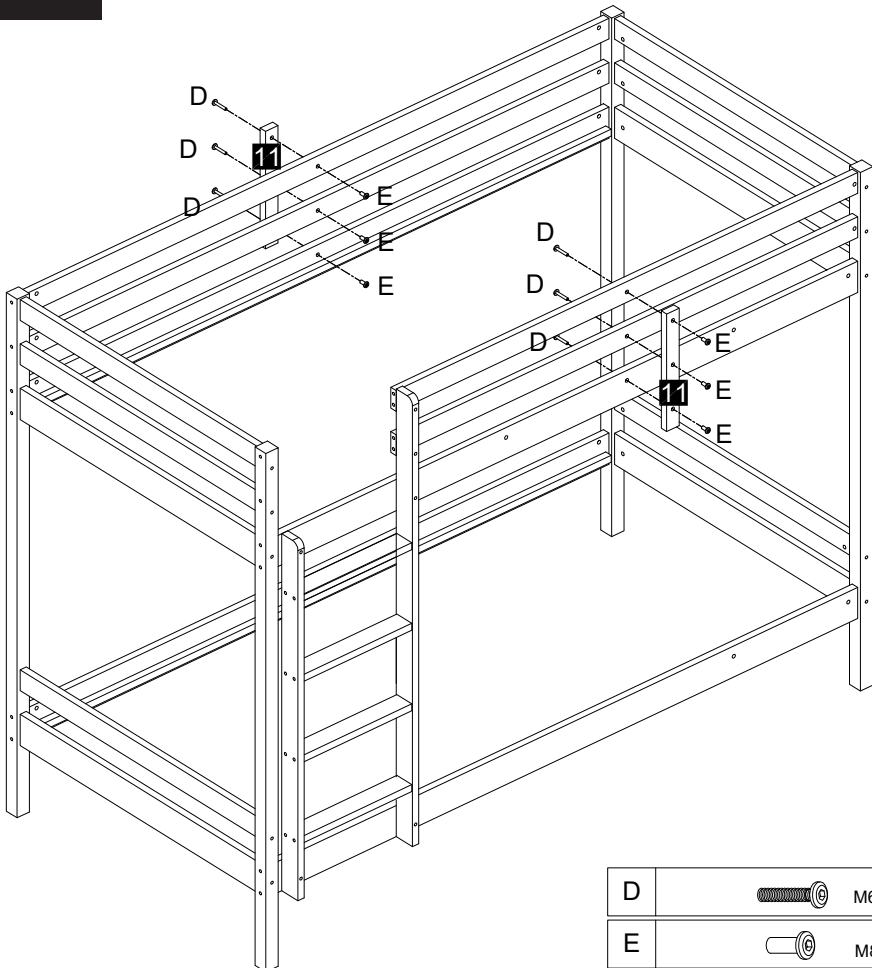

C		M6*70mm	6
E		M8*20mm	6

# STEP:6



D		M6*25mm	6
E		M8*20mm	6

# STEP:7

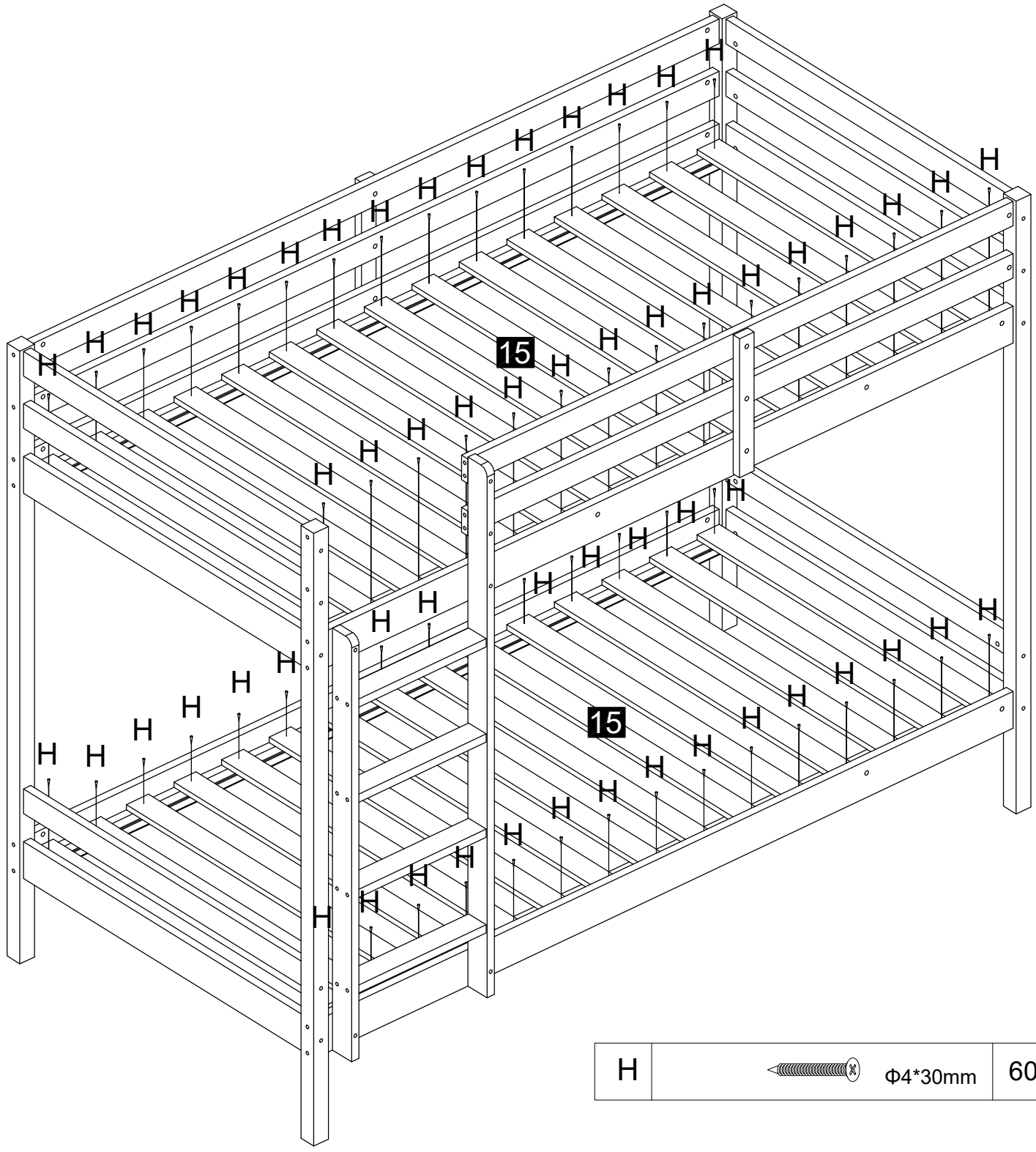

H		Φ4*30mm	60
---	---	---------	----