



# Assembly Instructions

**Caution: You must read this before you proceed**



## Chair



### Part List

Label	Picture	Description	QTY
A		Chair Part	1
B		Leg Part	1

## Hardware

Label	Picture	Description	QTY
①		Bolt (M8*20mm)	5
②		Allen Key	1

## Assembly Preparation

Before Beginning Assembly:

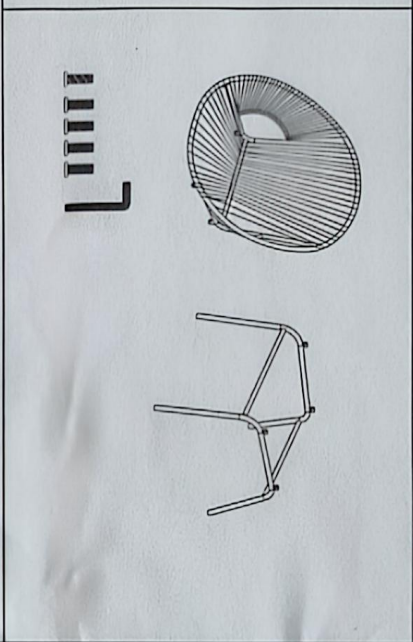

- Read instructions, cover to cover-
- Have 2 adults on hand for assembly-
- Do not assemble on flooring or carpet-
- Assemble on a clean non-marring surface (packing foam)-
- Save all packaging until finished-

## Assembly Steps

### Overview

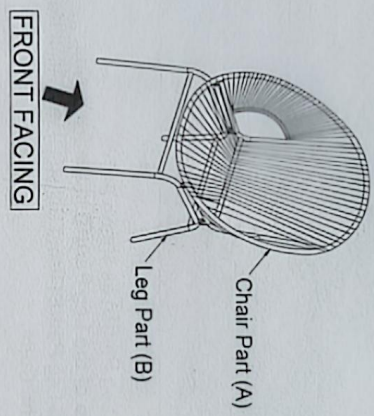

This Chair has multiple parts and may require up to 30 minutes to assemble. To give you an overview of the Chair parts, the above picture is to help you put the various parts into perspective. Please read through the instructions below to familiarise yourself with the parts and steps before assembly.

### Step 1

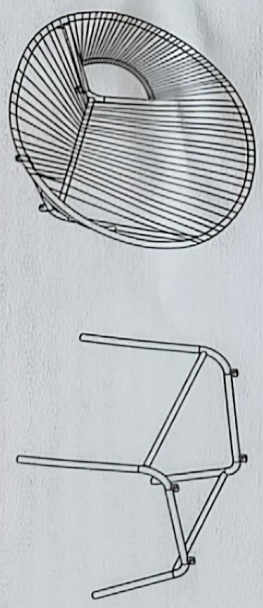

Unpack and place all parts on a clean, non-marring surface.

### Step 2

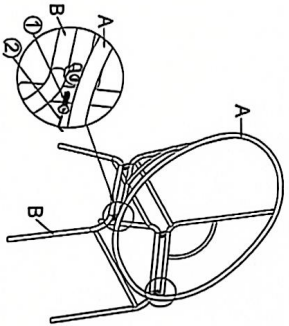

Align Chair Part(A) to Leg Part(B) as shown above.

**Note:** The higher side of the Leg Part(B) is the front side.

Attach Chair Part(A) to Leg Part(B) using Bolts (1) with Allen Key (2).

Do not fully tighten the Bolts.

### Step 3

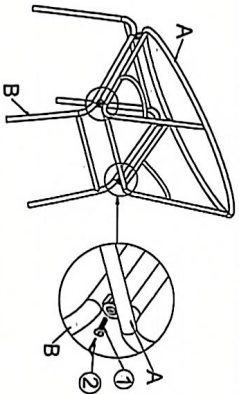

Attach Chair Part(A) to Leg Part(B) using Bolts (1) with Allen Key (2).

Place the Chair on a LEVEL SURFACE.

Inspect it and make sure all parts are adequately connected.

Gently and carefully sit onto the Chair.

This will help to align all parts at all joints.

Then get off the Chair, and in a sequential manner, proceed to tighten all Bolts.

When tightening the Bolts, tighten sequentially.

**DO NOT** tighten any Bolt fully and then move on to the next one.

This may cause the frame to warp.

If there are still wobbles, loosen the Bolts and execute this same process.

**Note:** This step is done best with the assistance of a second adult.

### Step 4

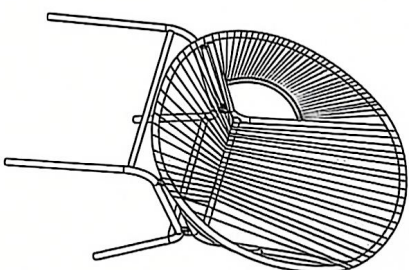

Your Chair is ready for use.

**This Chair can only be used on the flat, level surface.**

#### Care & Maintenance

- Prolonged exposure to rain may cause rusting which can stain floors.
- Do not put hot items directly on furniture surface.
- Do not clean furniture with harsh cleansers or polish.
- To obtain the longest lifespan of your outdoor products, minimizing exposure to direct sunlight is recommended.
- Children should not climb or jump on the furniture.
- Do not write on furniture without a padded barrier to protect the surface.
- To obtain the longest lifespan of your outdoor products, avoid extended and lengthy exposure to rain, snow, and direct sunshine. Whenever possible cover the product and /or place under patio or awnings.
- Not for commercial use. For residential use only.
- Stains may be removed with mild soap solution and damp cloth.
- Keep away from sources of ignition.
- Dust and pick-up spills using a clean, non-colored, lint-free cloth.

# Assembly Instructions

Caution : Please read carefully before you proceed

## TABLE



### Part List

Label	Picture	Description	QTY
A		Table Top Support	1
B		Leg	3
C		Fixed Ring	1
D		Glass Top	1



Hardware			
Label	Picture	Description	QTY
①		Bolt (M6*15mm)	7
②		Allen Key (M6)	1
③		Washer (M6)	6

  

Assembly Preparation	
Before Beginning Assembly:	
<ul style="list-style-type: none"> <li> Read instructions, cover to cover-</li> <li> Have 2 adults on hand for assembly-</li> <li> Do not assemble on flooring or carpet-</li> <li> Assemble on a clean non-marring surface (packing foam)-</li> <li> Save all packaging until finished-</li> </ul>	

Assembly Steps
<p><b>Overview</b></p>
<p>This Table has multiple parts and may require up to 30 minutes to assemble. To give you an overview of the Table parts, the above picture is provided to help put the various parts into perspective. Please read through the instructions below to familiarise yourself with the parts and steps before assembling.</p>
<p><b>Step 1</b></p>
<p>Unpack and place all parts on a clean, non-marring surface.</p>



### Step 2

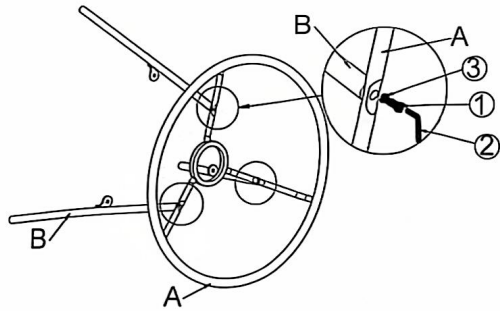

Place the Table Top Support (A) on the clean, non-marring surface.  
Using the Allen Key (2) attach one of the Legs (B) to Table Top Support (A) with Bolts (1) & Washer (3).  
**DO NOT FULLY TIGHTEN THE BOLTS.**  
Repeat the step with the remaining 2 Legs.

### Step 3

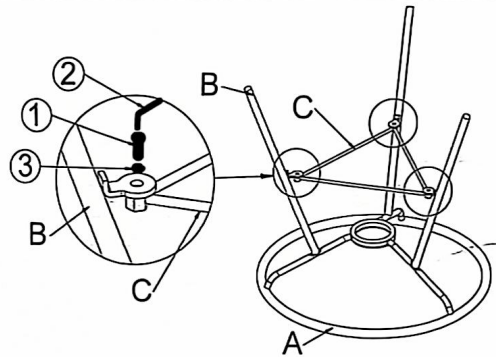

Place the Table Top Support (A) face down upon the non-marring surface.  
Place the Fixed Ring (C) as shown above.  
Using the Allen Key (2) attach the Fixed Ring (C) to Leg (B) using Bolts (1) & Washer (3).  
**DO NOT FULLY TIGHTEN THE BOLTS.**  
Repeat the step with remaining 2 Legs.

### Step 4

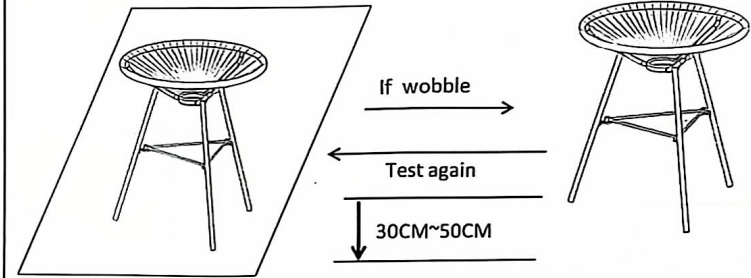

Place the table frame on a **LEVEL SURFACE** to see if it wobbles.

If it wobbles, lift the Table some 30cm to 50cm high from the ground.  
Keep your feet and toes well away from the drop zone.  
Drop the table frame freely and vertically with the four legs, hitting the ground, at the same time.  
This Drop Test will help to ensure that all the Bolts and gaps all reach full alignment status.  
Test again for evenness on a **LEVEL SURFACE**.  
If no wobbles are found, proceed to tighten all the Bolts.

When tightening the Bolts, tighten sequentially.  
**DO NOT** tighten any Bolt fully and then move on to the next one.  
This may cause the frame to warp.  
If there are still wobbles, loosen the Bolts and execute the same drop test.  
It is important to ensure the table is stable. If it is not stable it could lead to damage.



### Step 5

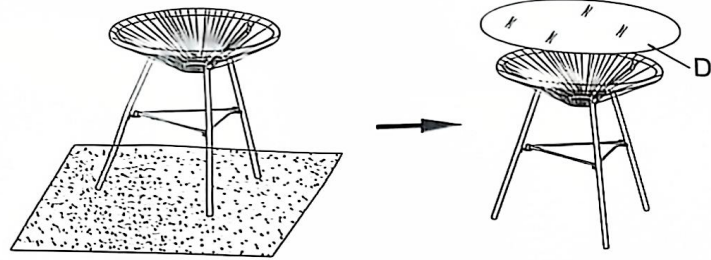











Take off the glass and level it before putting it on.  
Place Glass Top (D) on the top of the table.

### Step 6



Your Table is ready for use.  
This Table can only be used on a flat and level surface.

#### Care & Maintenance

-  • Prolonged exposure to rain may cause rusting which can stain floors.
-  • Do not put hot items directly on furniture surface.
-  • Do not clean furniture with harsh cleaners or polish.
-  • To obtain the longest lifespan of your outdoor products, minimizing exposure to direct sunlight is recommended.
-  • Children should not climb or jump on the furniture.
-  • Do not write on furniture without a padded barrier to protect the surface.
-  • To obtain the longest lifespan of your outdoor products, avoid extended and lengthy exposure to rain, snow, and direct sunlight. Whenever possible cover the product and/or place under patio or awnings.
-  • Not for commercial use. For residential use only.
-  • Stains may be removed with mild soap solution and damp cloth.
-  • Keep away from sources of ignition.
-  • Dust and pick-up spills using a clean, non-colored, lint-free cloth.

