

Insrallation Instruction

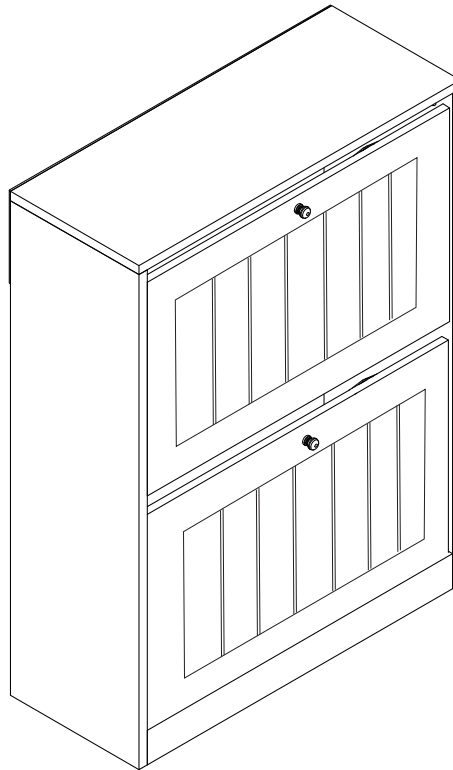

EN

1. Place all parts on a clean, flat, and soft surface (e.g., carpet or rug) to prevent scratches.
2. DO NOT USE POWER TOOLS FOR ASSEMBLY.
3. Do not sit, stand, or allow children to climb, sit, or stand on the assembled product.
4. KEEP ALL HARDWARE PARTS OUT OF CHILDREN'S REACH.
5. DISPOSE OF PLASTIC PACKAGING IMMEDIATELY TO PREVENT SUFFOCATION RISKS TO CHILDREN OR PETS.
6. For safety reasons, this unit must be securely mounted to the wall.
7. Assembly requires two people.

DE

1. Legen Sie alle Teile auf eine saubere, flache und weiche Oberfläche (z. B. Teppich oder Matte), um Kratzer zu vermeiden.
2. VERWENDEN SIE KEINE ELEKTROWERKZEUGE FÜR DEN ZUSAMMENBAU.
3. Setzen oder stellen Sie sich nicht auf das montierte Produkt, und lassen Sie Kinder nicht darauf klettern, sitzen oder stehen.
4. HALTE ALLE HARDWARETEILE AUSSERHALB DER REICHWEITE VON KINDERN.
5. ENTSORGEN SIE KUNSTSTOFFVERPACKUNGEN SOFORT, UM ERSTICKUNGSRISIKEN FÜR KINDER ODER HAUSTIERE ZU VERMEIDEN.
6. Aus Sicherheitsgründen muss diese Einheit sicher an der Wand befestigt werden.
7. Für den Zusammenbau werden zwei Personen benötigt.

FR

1. Placez toutes les pièces sur une surface propre, plate et molle (par exemple, un tapis ou une moquette) pour éviter les rayures.
2. N'UTILISEZ PAS D'OUTILS ÉLECTRIQUES POUR LE MONTAGE.
3. Ne vous asseyez pas, ne vous tenez pas debout et ne laissez pas les enfants grimper, s'asseoir ou se tenir debout sur le produit assemblé.
4. GARDEZ TOUTES LES PIÈCES DE QUINCAILLERIE HORS DE PORTÉE DES ENFANTS.
5. ÉLIMINEZ IMMÉDIATEMENT LES EMBALLAGES PLASTIQUES POUR ÉVITER TOUT RISQUE D'ÉTOUFFEMENT POUR LES ENFANTS OU LES ANIMAUX DOMESTIQUES.
6. Pour des raisons de sécurité, cette unité doit être solidement fixée au mur.
7. Le montage nécessite deux personnes.

ES

1. Coloque todas las partes sobre una superficie limpia, plana y suave (por ejemplo, alfombra o tapete) para evitar rayaduras.
2. NO UTILICE HERRAMIENTAS ELÉCTRICAS PARA EL ENSAMBLAJE.
3. No se siente, no se pare ni permita que los niños se suban, se sienten o se paren sobre el producto ensamblado.
4. MANTENGA TODAS LAS PIEZAS DE HERRAMIENTA FUERA DEL ALCANCE DE LOS NIÑOS.
5. DESECHE INMEDIATAMENTE LOS ENVASES DE PLÁSTICO PARA EVITAR CUALQUIER RIESGO DE ASFIXIA PARA NIÑOS O MASCOTAS.
6. Por razones de seguridad, es imprescindible que esta unidad esté fijada a la pared.
7. Se necesitan dos personas para el ensamblaje.

Technical Support : service0530@163.com



MADE IN CHINA

IT

1. Posizionare tutte le parti su una superficie pulita, piana e morbida (ad esempio, tappeto o moquette) per evitare graffi.
2. NON UTILIZZARE UTENSILI ELETTRICI PER IL MONTAGGIO.
3. Non sedersi, non stare in piedi e non permettere ai bambini di arrampicarsi, sedersi o stare in piedi sul prodotto assemblato.
4. TENERE TUTTE LE PARTI DI FERRAMENTA FUORI DALLA PORTATA DEI BAMBINI.
5. SMALTIRE IMMEDIATAMENTE GLI IMBALLAGGI DI PLASTICA PER EVITARE QUALSIASI RISCHIO DI SOFFOCAMENTO PER BAMBINI O ANIMALI DOMESTICI.
6. Per motivi di sicurezza, è imperativo che questa unità sia fissata al muro.
7. Per il montaggio sono necessarie due persone.

WARNING!!

Children have died from furniture tipover. Tip restraints have been included with this product; you must install the tip restraints according to these instructions in order to minimize the risk of furniture tipping.

- In addition to installing the restrains , to help prevent tip-over**
1. **NEVER** put a TV or other heavy objects on top of this product".
 2. **Do not stand on the product.**

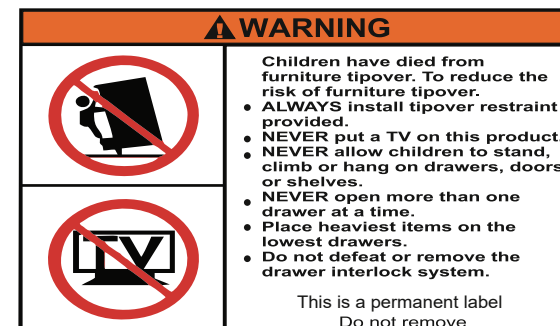

Assembly Instructions

YX-YQLC-0101 2 TIER PANELLED SHOE CABINET









WARNING:





THIS PACKAGE CONTAINS SMALL PARTS AND SHARP POINTS. KEEP AWAY FROM CHILDREN AND BABIES. **MAXIMUM SAFE LOAD: 10KG FOR TOP PANEL, 5KG FOR INSIDE DRAWER.** IT IS STRONGLY RECOMMENDED THAT THIS PRODUCT IS PERMANENTLY FIXED TO THE WALL.

IT IS RECOMMENDED FOR 2 PEOPLE TO ASSEMBLE/MOVE THIS ITEM TO AVOID ANY POTENTIAL INJURY AND/OR DAMAGE.

CARE INSTRUCTION: WIPE CLEAN WITH A SOFT DRY OR DAMP CLOTH. CHECK AND TIGHTEN ALL PARTS REGULARLY.

Hardware List

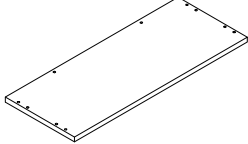
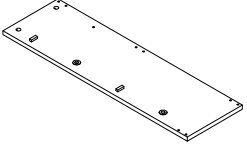
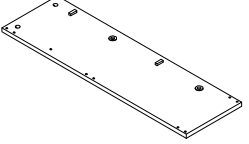
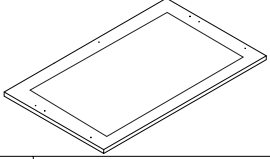
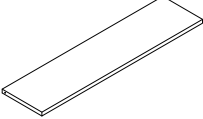
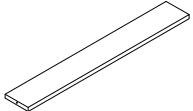
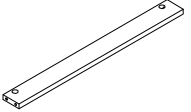
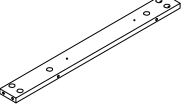
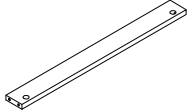

	a	6x35mm	20pcs
	b	15x9.5mm	20pcs
	c	6x30mm	8pcs
	d		4pcs
	e		4pcs
	f		2pcs
	g		2pcs
	O		2pcs

	h	M4x12mm	16pcs
	i		4pcs
	k	M4x30mm	12pcs
	l	∅3.5x12mm	2pcs
	m	∅ 6x30mm ∅4x35mm	2pcs

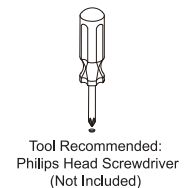
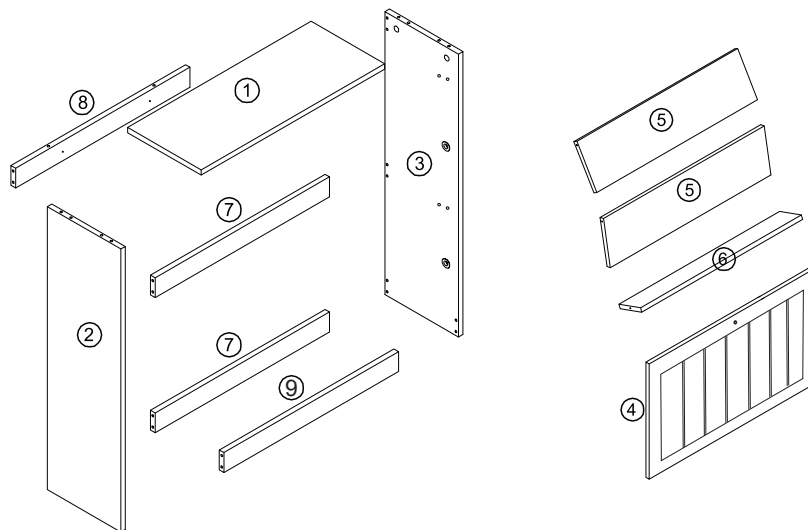
	①	1PC		②	1PC		③	1PC
	④	2PCS		⑤	4PCS		⑥	2PCS
	⑦	2PCS		⑧	1PC		⑨	1PC



STEP 5

-  a x 6
-  b x 6
-  c x 4

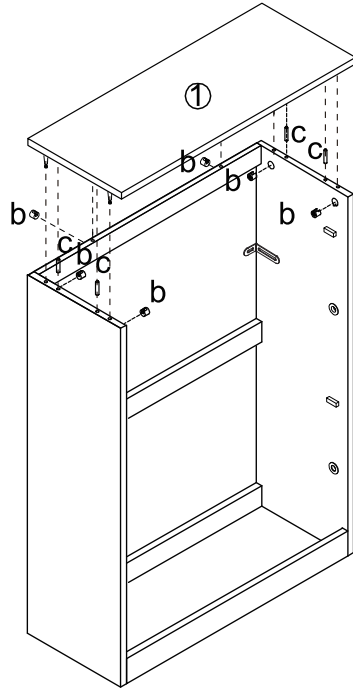
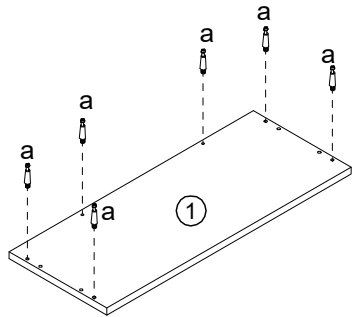

STEP 6

-  m x 2

FIX ON WALL

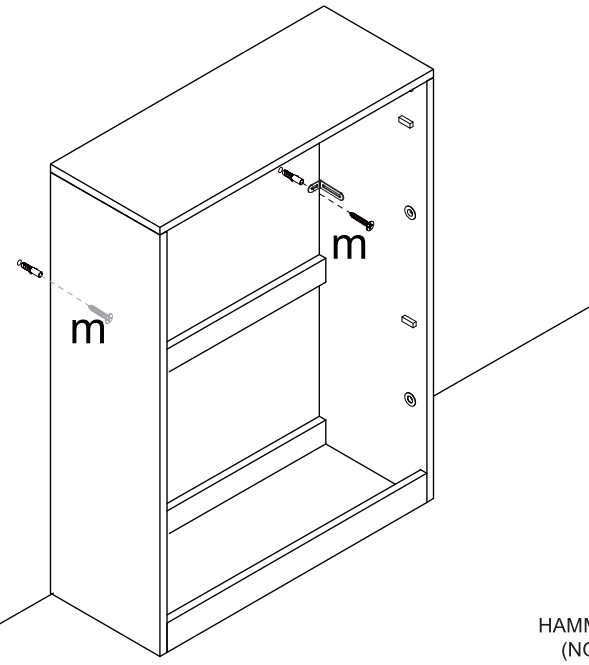

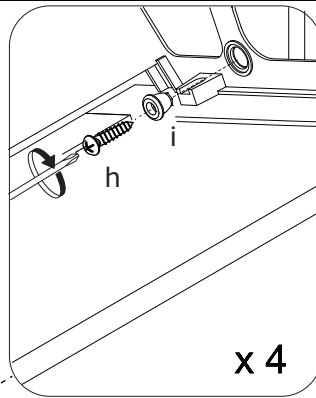
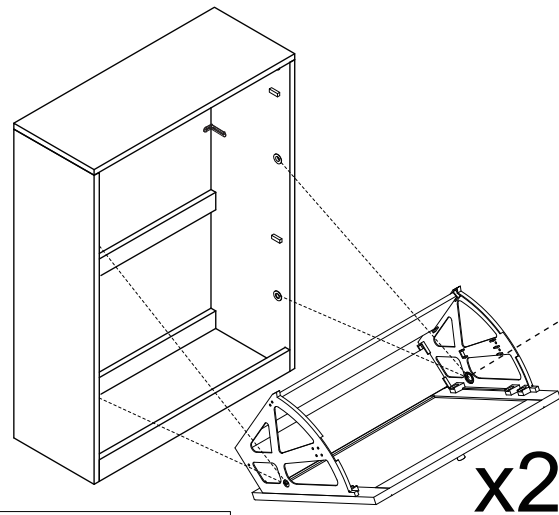

HAMMER REQUIRED
(NOT PROVIDED)

STEP 7

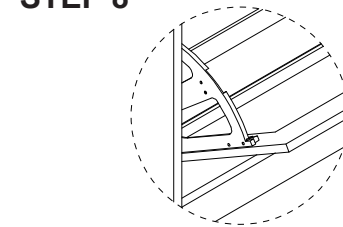

x 4

STEP 8



or

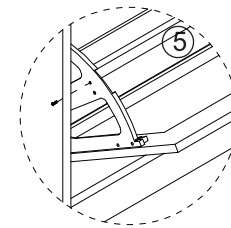

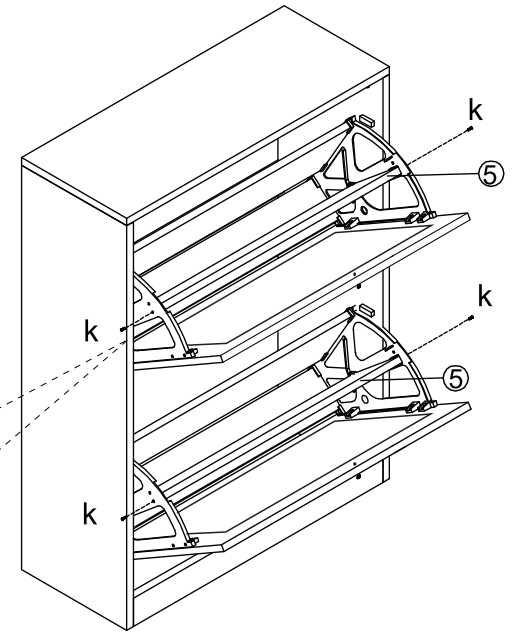
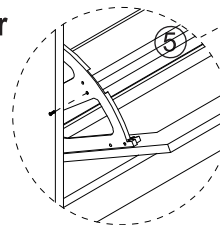

or



-  k x 4

NOTE: Board ⑤ is adjustable or removable to fit different shoes sizes.

-  h x 4
-  i x 4

STEP 9

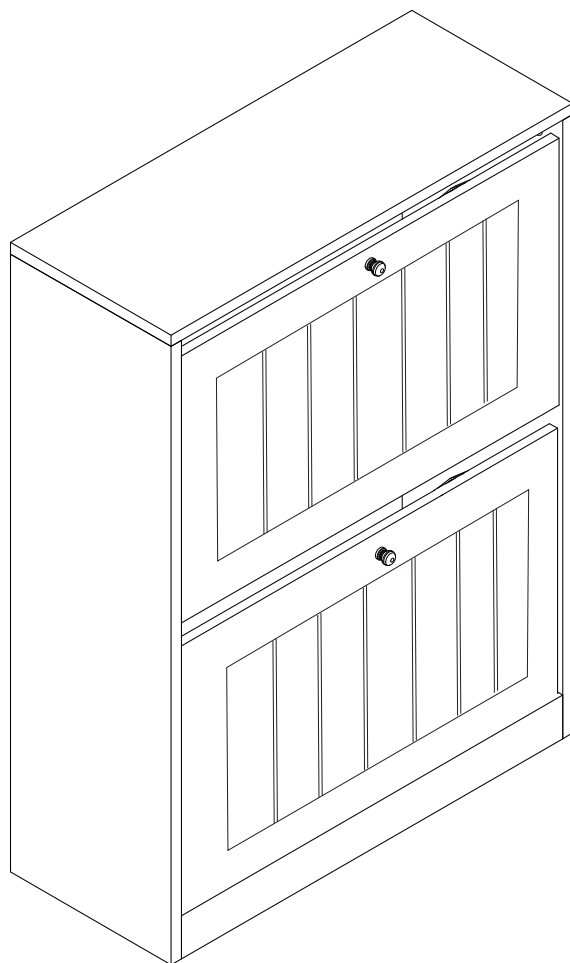

⚠ WARNING

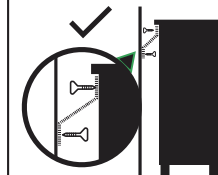

Children have died from furniture tipover.

- ALWAYS secure it with an anchor device.
- NEVER allow children to stand, climb or hang on drawers, doors, or shelves.
- NEVER open more than one drawer at a time.
- Place heavy items down low.

NEVER put a TV
on this furniture



This is a permanent label. Do not remove!

TOPPLING FURNITURE WARNING:

- **It is strongly recommended that this product is permanently fixed to the wall.**
- **Please seek professional advice if you are in doubt of what fixing device to use.**
- **Regularly check that anchors are securely maintained.**
- **Use safety drawer locks to prevent children climbing.**
- **Stability of tall items may be affected by thick pile carpet or uneven floors .**
- **Do not place unanchored televisions on furniture .**

CAUTION: for your safety when attaching the anchor fixings, please note the following:

- **Check any electrical wires or plumbing inside the wall before drilling any holes (if you are unsure please seek professional advice from a qualified tradesperson).**



TOPPLING HAZARD

WARNING: PLEASE SECURE
YOUR FURNITURE WITH
THE SUPPLIED WALL FIXING.
SCAN THE CODE FOR
MORE INFORMATION.

