



FR
Cet appareil,
ses cordons,
et batterie
se recyclent

À DÉPOSER
EN MAGASIN

À DÉPOSER
EN DÉCHÈTERIE



Points de collecte sur www.quefairedesdechets.fr
Privilégiez la réparation ou le don de votre appareil !



MONTAGEANLEITUNG

N653P359233/N653P359234/N653P359235

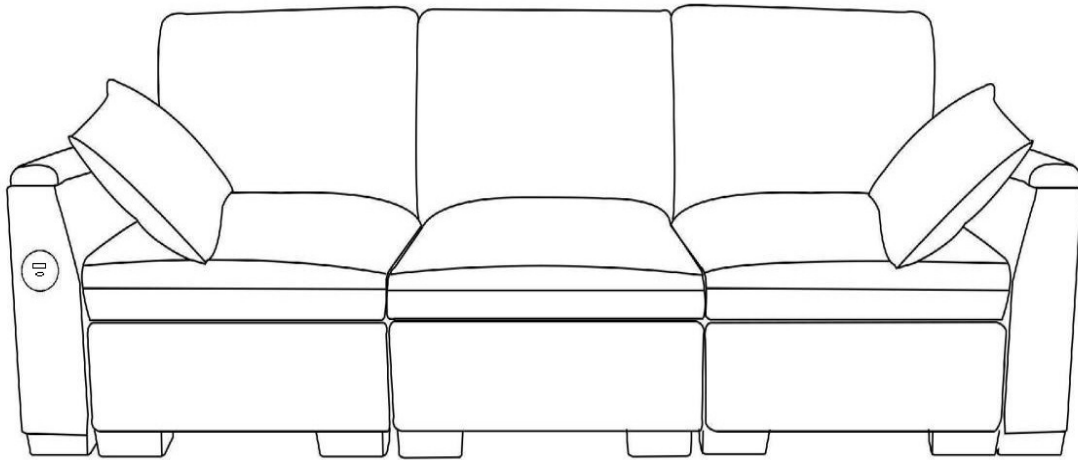

Sets werden normalerweise in mehreren Kartons versendet,
die Liefertermine können variieren.

KUNDENDIENST

Fragen, fehlende Teile, Montagehilfe?

Eine Rücksendung ist nicht erforderlich, wir helfen Ihnen gerne weiter und
versenden Ihr Ersatzteil kostenlos.



[DE]

Achtung: Lesen Sie die Anleitung vor dem Zusammenbau bitte vollständig durch. Überprüfen Sie, ob Sie alle auf den Seiten aufgeführten Komponenten und Werkzeuge haben.

Achtung: Überprüfen Sie regelmäßig alle Beschläge und Befestigungen, um sicherzustellen, dass sie sicher sind und um Unfälle zu vermeiden.

Achtung: Stellen Sie Möbel nicht in die Nähe von Feuerquellen oder heißen Gegenständen, um Brandgefahr zu vermeiden.

Achtung: Erlauben Sie Kindern nicht, auf die Möbel zu klettern, da dies zum Umkippen und zu schweren Verletzungen führen kann. Bauen Sie die Möbel außerhalb der Reichweite von Kindern zusammen.

[EN]

Warning: Please read instructions fully before starting assembly. Check you have all the components and tools listed on pages.

Warning: Regularly check all fittings and fastenings to ensure they are secure and to prevent accidents

Warning: Do not place furniture close to fire sources or high-temperature objects to avoid the risk of fire.

Warning: Do not allow children to climb on the furniture as this may result in tipping and serious personal injury. Assemble the furniture away from the reach of children.

[FR]

Avertissement: Veuillez lire entièrement les instructions avant de commencer l'assemblage. Vérifiez que vous disposez de tous les composants et outils répertoriés sur les pages.

Avertissement: Vérifiez régulièrement tous les accessoires et fixations pour vous assurer qu'ils sont bien fixés et pour éviter les accidents

Avertissement: Ne placez pas les meubles à proximité de sources de feu ou d'objets à haute température pour éviter tout risque d'incendie.

Avertissement: Ne laissez pas les enfants grimper sur les meubles car cela pourrait entraîner un basculement et des blessures graves. Assemblez les meubles hors de portée des enfants.

[IT]

Attenzione: leggere attentamente le istruzioni prima di iniziare il montaggio. Verificare di avere tutti i componenti e gli utensili elencati nelle pagine.

Attenzione: controllare regolarmente tutti i raccordi e gli elementi di fissaggio per assicurarsi che siano sicuri e prevenire incidenti

Attenzione: non posizionare i mobili vicino a fonti di fuoco o oggetti ad alta temperatura per evitare il rischio di incendio.

Attenzione: non consentire ai bambini di arrampicarsi sui mobili poiché ciò potrebbe causare ribaltamenti e gravi lesioni personali. Montare i mobili lontano dalla portata dei bambini.

[ES]

Advertencia: Lea las instrucciones completamente antes de comenzar el montaje. Compruebe que tiene todos los componentes y herramientas que se enumeran en las páginas.

Advertencia: Compruebe periódicamente todos los accesorios y sujeciones para asegurarse de que estén seguros y evitar accidentes.

Advertencia: No coloque los muebles cerca de fuentes de fuego u objetos a alta temperatura para evitar el riesgo de incendio.

Advertencia: No permita que los niños se suban a los muebles, ya que esto puede provocar que vuelquen y lesiones personales graves. Monte los muebles fuera del alcance de los niños.



[DE]

Warnung: Die maximale Belastbarkeit dieses Möbels beträgt: 100kg, bitte nicht überlasten!

[EN]

Warning: The maximum load-bearing capacity of this furniture is:100kg, please do not overload!

[FR]

Avertissement: La capacité de charge maximale de ce meuble est de : 100 kg, merci de ne pas surcharger !

[IT]

Attenzione: La capacità di carico massima di questo mobile è:100kg, non sovraccaricare!

[ES]

Advertencia: La capacidad máxima de carga de este mueble es:100kg, ¡no lo sobrecargue!

Importeur	Decobus Handel GmbH
Adresse	Innungsstraße 9, 21244 Buchholz, Deutschland
Email/URL	https://www.decobusgroup.de
Hersteller	XINYANG QUAN SHENG INDUSTRIAL CO.,LTD
Adresse	NO.4, BUILDING 5, INCUBATION PARK FOR SMALL AND MEDIUM ENTERPRISES,HOME TOWN,YANGSHAN NEW DISTRICT,XINYANG CITY,CHINA
Email/URL	quansheng_ss001@163.com
Partienummer	N653P359233/N653P359234/N653P359235
Hersteller in	Hergestellt In China
<div style="border: 1px solid black; display: inline-block; padding: 2px;">EC</div> <div style="border: 1px solid black; display: inline-block; padding: 2px; margin-left: 10px;">REP</div>	Decobus Handel GmbH Innungsstraße 9, 21244 Buchholz, Deutschland https://www.decobusgroup.de

Importeur	Decobus Handel GmbH
Adresse	Innungsstraße 9, 21244 Buchholz, Deutschland
Email/URL	https://www.decobusgroup.de
Hersteller	Jiangsu Shangruisi Technology Co., Ltd
Adresse	Nr. 19, Jingsheng Road, Stadt Qianqiao, Bezirk Huishan, Stadt Wuxi, Provinz Jiangsu
Email/URL	quansheng_ss001@163.com
Partienummer	N653P359233/N653P359234/N653P359235
Hersteller in	Hergestellt In China
	Decobus Handel GmbH Innungsstraße 9, 21244 Buchholz, Deutschland https://www.decobusgroup.de



Produkt: SWITCHING ADAPTER

Modell: M4-050200A1

Nennspannung: 5V

Nennfrequenz: 50/60Hz

Leistung: 10W

01

N653P359233



A 1PC



D 1PC

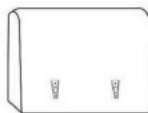

F 1PC



H 1PC

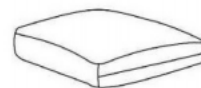

I 1PC

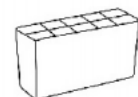

150*50*H80mm

① 6PCS



M5*50mm

② 12PCS

N653P359235



B 1PC

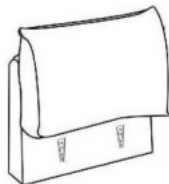

G 1PC

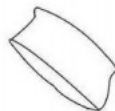

J 2PC



I 1PC

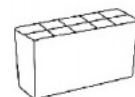

150*50*H80mm

① 4PCS



③ 1PC



M5*50mm

② 8PCS

N653P359234



C 1PC



E 1PC

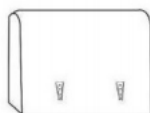

F 1PC



H 1PC

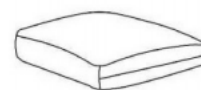

I 1PC

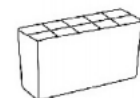

150*50*H80mm

① 6PCS



M5*50mm

② 12PCS

All Accessories



A 1PC



B 1PC



C 1PC

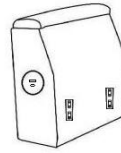

D 1PC

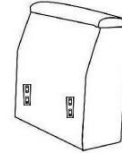

E 1PC

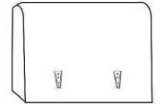

F 2PC

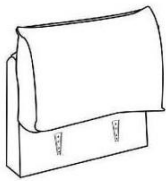

G 1PC



H 2PC

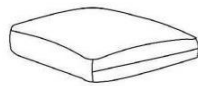

I 3PCS



J 2PC

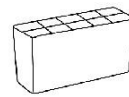

150*50*H80mm
① 16PCS



M5*50mm
② 32PCS



③ 1PC

02

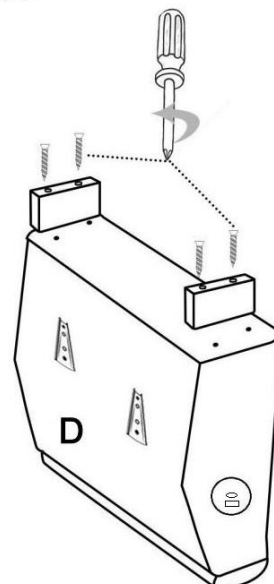
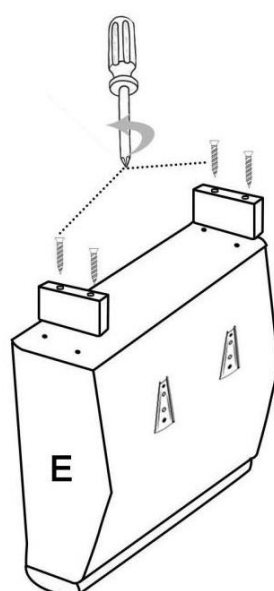
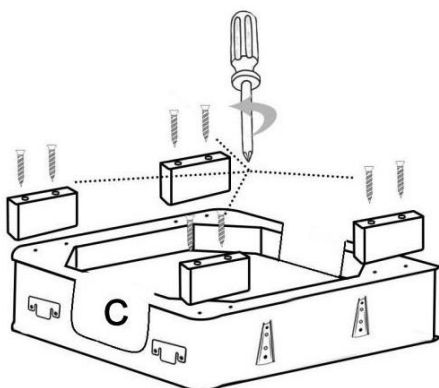
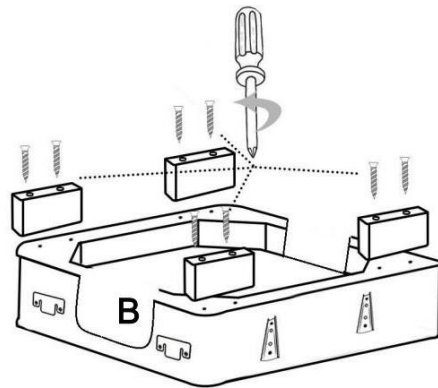
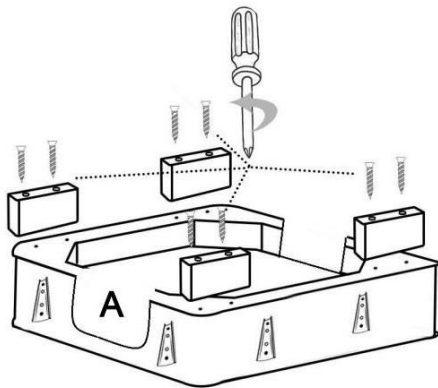

03

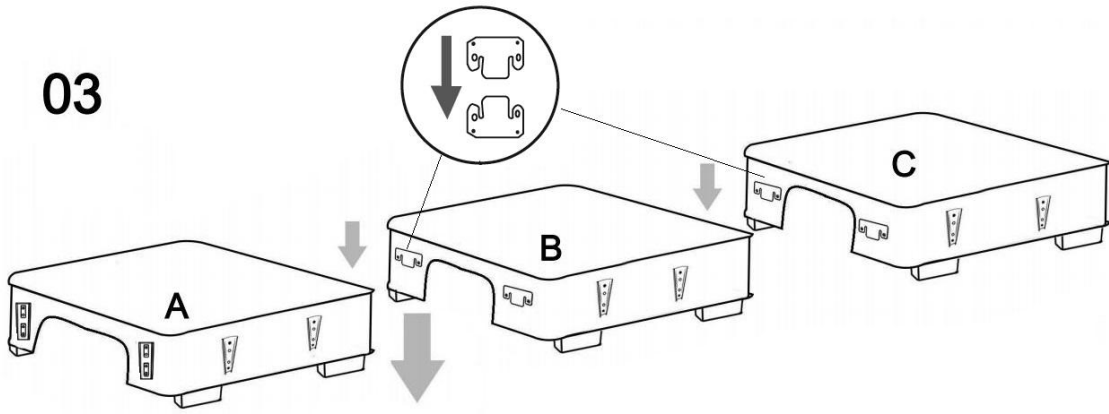

04

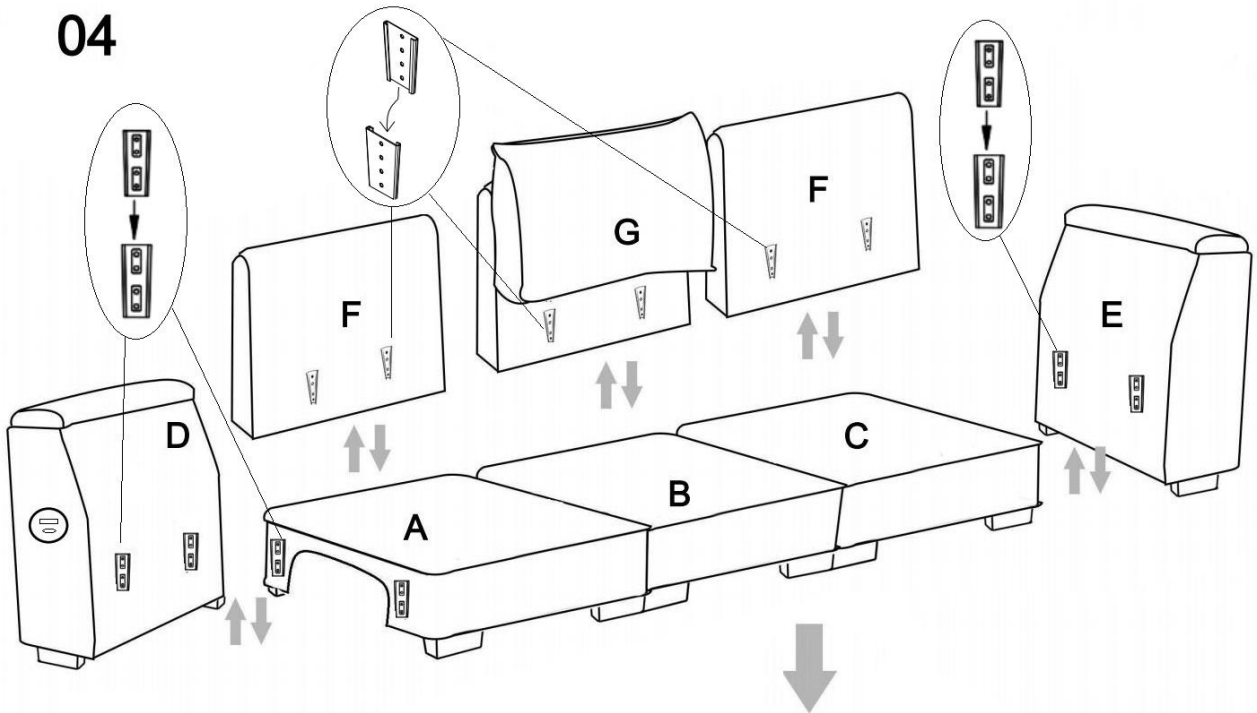

05

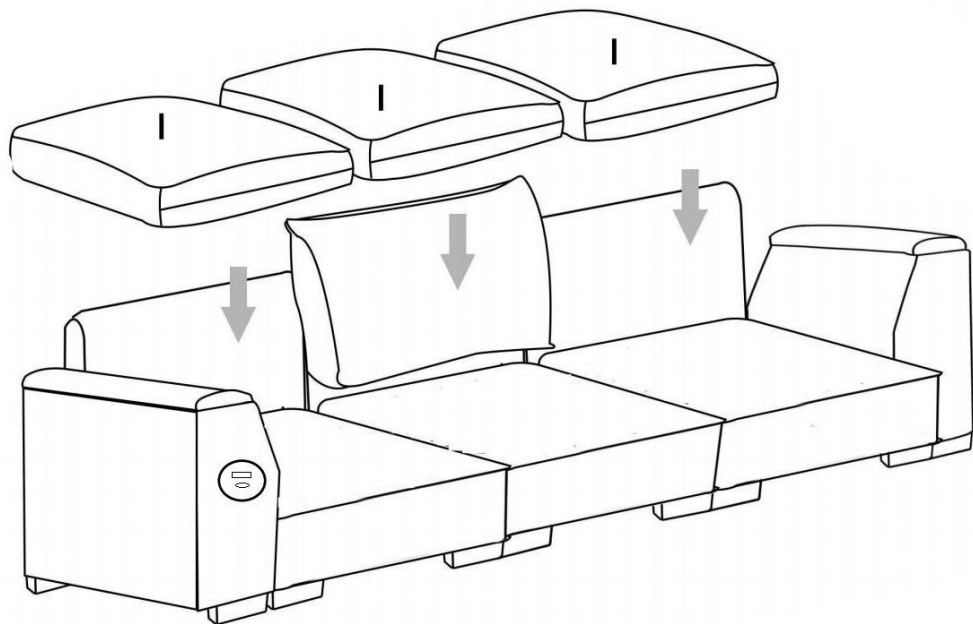

06

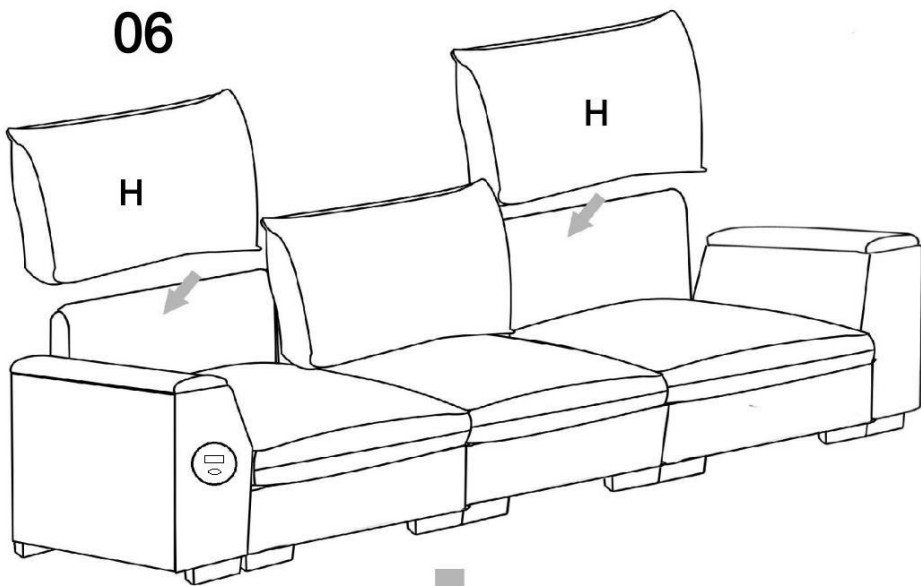

07

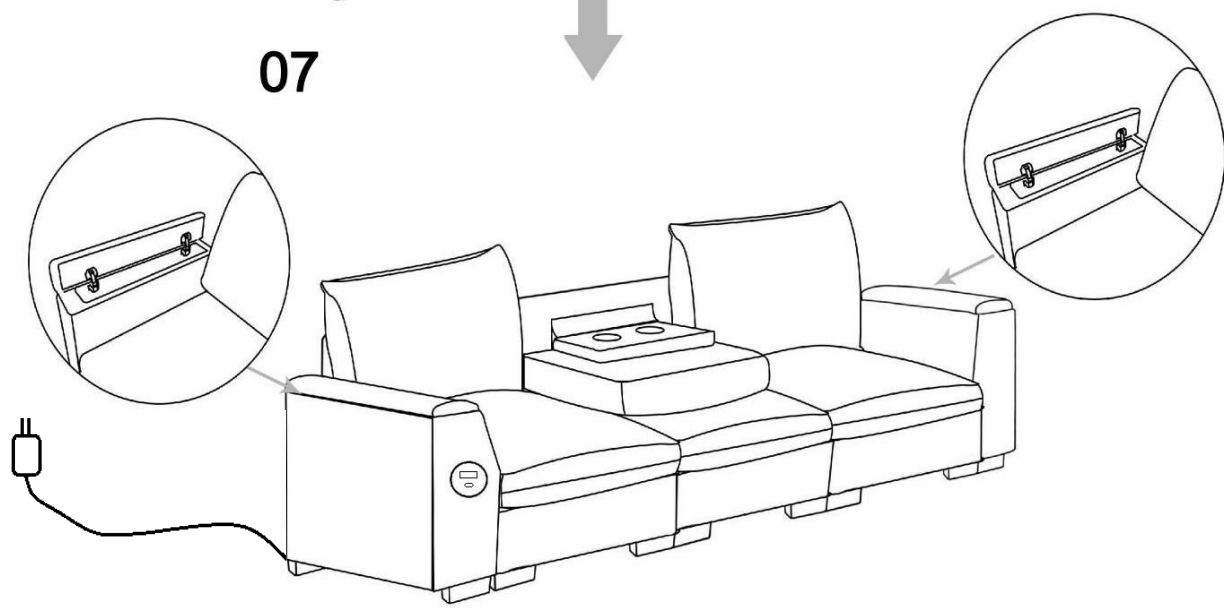

08

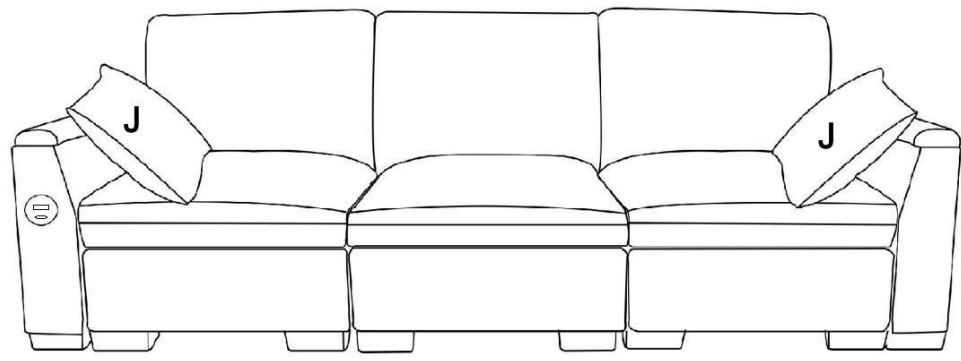



Keyway Testing Technology (Guangdong) Co., Ltd.
Room 2102, Building 6, Dongyi Intelligent Equipment
NewEnergy Vehicle Park, No.30 of Tangxia District,
Dongshen Road, TangxiaTown, Dongguan City,
Guangdong province, China

Tel : 86-769-87182258

Fal : 86-769-87181058

Mail : kwtest@keywaytest.com

Certificate of Conformity

No. CA25020057-S-000

The following products have been tested by us with the listed standards and found in Conformity with the council LVD directive 2014/35/EU. It is possible to use CE marking to demonstrative the Conformity with this LVD Directive. (Type Examination Certificate).

Applicant : Shenzhen Chuangjia Power Technology Co., Ltd

Address : 403, No. 76 Furui Road, Rentian Community,
Fuhai Street, Bao'an District, Shenzhen City

Product : Power adapter

Trade Name : /

Model No. : M8-0510CU, M4-0510CU, M8-050100A1, M4-050100A1,
YT-050100A1, YT-0510A1, DYX-0501000EU, M8-0515CU,
M4-0515CU, M8-050150A1, M4-050150A1, YT-050150A1,
YT-0515A1, DYX-0501500EU, M8-0520CU, M4-0520CU,
M8-050200A1, M4-050200A1, YT-050200A1, YT-0520A1,
DYX-0502000EU

Test Standards :

EN IEC 62368-1:2020 +
A11:2020

Audio/video, information and
communication technology
equipment
Part 1: Safety requirements



Toney Cao

Supervisor

Date: 14, 03, 2025

The statement is based on a single evaluation of one sample of above mentioned products. It does not imply an assessment of the whole production and does not permit the use of the test lab. logo.



Keyway Testing Technology (Guangdong) Co., Ltd.
21st Floor, Building 6, Dongyi Intelligent Equipment
New Energy Vehicle Park, No.30 of Tangxia District,
Dongshen Road, Tangxia Town, Dongguan City,
Guangdong province, China

Tel : 86-769-8718 2258
Fax : 86-769-8718 1058
Mail : kwtest@Keywaytest.com

Certificate of Conformity

No. CA25020054-E-000

Applicant : Shenzhen Chuangjia Power Technology Co., Ltd
Address : 403, No. 76 Furui Road, Rentian Community, Fuhai Street,
Bao'an District, Shenzhen City
Trade Name : N/A
Product : Power adapter
Model No. : M8-0510CU, M4-0510CU, M8-050100A1, M4-050100A1,
YT-050100A1, YT-0510A1, DYX-0501000EU, M8-0515CU,
M4-0515CU, M8-050150A1, M4-050150A1, YT-050150A1,
YT-0515A1, DYX-0501500EU, M8-0520CU, M4-0520CU,
M8-050200A1, M4-050200A1, YT-050200A1, YT-0520A1,
DYX-0502000EU
Report No. : TR25020054-E-000

The submitted sample of the above equipment has been tested and found to comply with the following European Directive and the following standards:

- Electromagnetic directive 2014/30/EU
- Standards

EN 55032:2015+A1:2020
EN 55032:2015+A11:2020
EN 55035:2017+A11:2020
EN IEC 61000-3-2:2019+A1:2024
EN 61000-3-3:2013+A2:2021

This certificate is part of the full test report(s) and should be read in conjunction with it. The referred test report(s) show that the product complies with standard(s) recognized as giving presumption of compliance with the essential requirements in the specified European Directive.

This certificate does not imply assessment of the production of the product.

The CE marking may be affixed if all relevant and effective European Directives are applicable.



Date: Feb. 21, 2025

Without the written approval of Keyway Testing Technology (Guangdong) Co., Ltd., this certificate is not permitted to be reproduced, except in full. It is not permitted to use the test lab's logo.